

MAVIC PRO

Quick Start Guide

V1.0

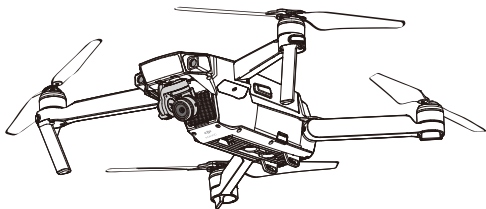

Aircraft

The DJI™ MAVIC™ Pro is DJI's smallest flying camera, featuring a fully stabilized camera, Intelligent Flight Modes and Obstacle Avoidance inside a revolutionary folding design. It captures 4K videos and 12 megapixel photos, and is capable of both ActiveTrack™ and TapFly™ making complex shots effortless.

Mavic Pro boasts a maximum flight speed of 40 mph (65 kph) and a maximum flight time of 27 minutes*.

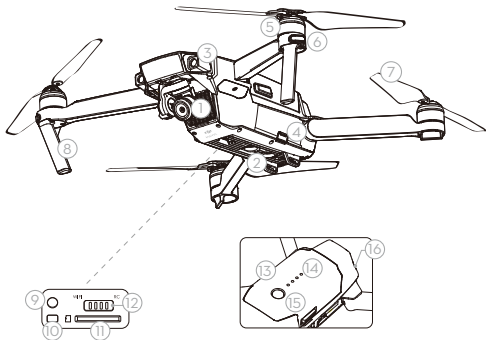

- | | |
|----------------------------|--------------------------------|
| 1. Gimbal and Camera | 9. Link Button |
| 2. Downward Vision System | 10. Linking Status Indicator |
| 3. Forward Vision System** | 11. Camera Micro SD Card Slot |
| 4. Micro USB Port | 12. Control Mode Switch |
| 5. Motors | 13. Intelligent Flight Battery |
| 6. Front LEDs | 14. Battery Level LEDs |
| 7. Propellers | 15. Power Button |
| 8. Antennas | 16. Aircraft Status Indicator |

* Maximum flight time was tested in 0 wind at a consistent 15.5 mph (25 kph). This value should be taken for reference only.

** The Forward Vision System is affected by surrounding conditions. Read the Disclaimer and Safety Guidelines and watch the tutorial in the DJI GO™ app or on the Official DJI website to learn more.

Remote Controller

Built into the Remote Controller is DJI's latest long-range transmission technology OCUSYNC™, offering a maximum transmission range of 4.3 mi (7 km). An on-board LCD screen keeps you updated on aircraft data, and video from the aircraft to the DJI GO app on your mobile device at up to 1080p at close range, and 720p at longer ranges. The Mavic Pro can also be flown by phone only.

Maximum run-time: 2.5 hours*

1. LCD Screen
2. 5D Button
3. Control Sticks
4. Antennas
5. Power Button
6. Flight Mode Switch
7. Mobile Device Clamp
8. USB Port
9. Flight Pause Button
10. RTH Button

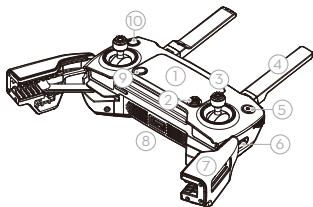

Folded

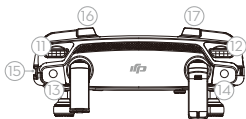

11. Gimbal Dial
12. Camera Settings Dial
13. Record Button
14. Shutter Button
15. Power Port (Micro USB)
16. C1 Button (customizable)
17. C2 Button (customizable)

* The remote controller is able to reach its maximum transmission distance (FCC) in a wide open area with no Electro-Magnetic Interference, and at an altitude of about 400 feet (120 meters).

The maximum run-time is tested under laboratory environment, only for your reference.

Specifications

• Aircraft

Weight	1.62 lbs (734 g)
Weight (including gimbal cover)	1.64 lbs (743 g)
Max Ascent Speed	16.4 ft/s (5 m/s) in Sport Mode
Max Descent Speed	9.8 ft/s (3 m/s)
Max Speed	40 mph (65 kph) in Sport Mode without wind
Max Service Ceiling Above Sea Level	16404 feet (5000 m)
Max Flight Time	27 minutes (0 wind at a consistent 15.5 mph (25 kph))
Max Hovering Time	24 minutes (0 wind)
Max Flight Distance	8 mi (13 km, 0 wind)
Operating Temperature	32° to 104° F (0° to 40° C)
Satellite Positioning Systems	GPS/GLONASS

• Gimbal

Controllable Range	Pitch: -90° to +30°, Roll: 0° or 90° (Horizontally and vertically)
--------------------	--

• Forward Vision System

Sensing Range	Precision measurement range: 2 ft (0.7 m) to 49 ft (15 m) Detectable range: 49 ft (15 m) to 98 ft (30 m)
Operating Environment	Surfaces with clear patterns and adequate lighting (lux > 15)

• Downward Vision System

Velocity Range	≤ 22.4 mph (36 kph) at 6.6 ft (2 m) above ground
Altitude Range	1 - 43 feet (0.3 - 13 m)
Operating Range	1 - 43 feet (0.3 - 13 m)
Operating Environment	Surfaces with a clear patterns and adequate lighting (lux > 15)

• Camera

Sensor	1/2.3" CMOS Effective pixels: 12.35 Megapixels (Total pixels: 12.71 M)
Lens	78.8° FOV, 28 mm (35 mm format equivalent) f/2.2 Distortion < 1.5% Focus from 0.5 m to ∞
ISO Range	100 - 3200 (video), 100 - 1600 (photo)
Electronic Shutter Speed	8 s to 1/8000 s
Max Image Size	4000×3000
Still Photography Modes	Single shot Burst shooting: 3/5/7 frames Auto Exposure Bracketing (AEB): 3/5 bracketed frames at 0.7EV Bias Interval

Video Recording Modes	C4K: 4096×2160 24p, 4K: 3840×2160 24/25/30p 2.7K: 2704×1520 24/25/30p FHD: 1920×1080 24/25/30/48/50/60/96p HD: 1280×720 24/25/30/48/50/60/120p
Video Storage Bitrate	60 Mbps
Supported File Systems	FAT32 (≤ 32 GB), exFAT (> 32 GB)
Photo	JPEG, DNG
Video	MP4, MOV (MPEG-4 AVC/H.264)
Supported SD Cards	microSD™. Max capacity: 64 GB Class 10 or UHS-1 rating required.
• Remote Controller	
Operating Frequency	2.4 GHz to 2.4835 GHz
Max Transmission Distance	FCC Compliant: 4.3 mi (7 km); CE Compliant: 2.5 mi (4 km) Unobstructed and free of interference.
Operating Temperature	32° to 104° F (0° to 40° C)
Battery	2970 mAh
Transmitter Power (avg. EIRP)	FCC: ≤ 26 dBm; CE: ≤ 20 dBm
Operating Voltage	950 mA @ 3.7 V
Supported Mobile Device Size	Thickness supported: 6.5 - 8.5 mm, Max length: 160 mm Supported USB port types: Lightning, Micro USB (Type-B), USB Type-C™
• Charger	
Voltage	13.05 V
Rated Power	50 W
• Intelligent Flight Battery	
Capacity	3830 mAh
Voltage	11.4 V
Battery Type	LiPo 3S
Energy	43.6 Wh
Net Weight	Approx. 0.5 lbs (240 g)
Charging Temperature Range	41° to 104° F (5° to 40° C)
Max Charging Power	100 W

For more information, read the User Manual:

<http://www.dji.com/mavic>

※ This content is subject to change without prior notice.

1. Download the DJI GO App and Watch the Tutorial Videos

Search for 'DJI GO' on the App Store or Google Play, or scan the QR code to download the app on your mobile device. Watch the tutorial videos at www.dji.com or in the DJI GO App.



DJI GO app and more information



• DJI GO supports iOS 8.0 (or later) or Android 4.3 (or later).

2. Check the Battery Levels

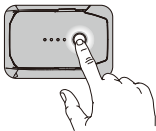

Low ● — Battery Level → High



Press once to check the battery level.
Press once, then again and hold to turn on/off.

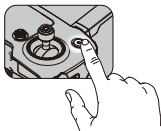

BAT 100 PCT

Battery Level: 100%

Press once to check the battery level on LCD screen. Press once, then again and hold to turn on/off the remote controller.

3. Charge the Batteries

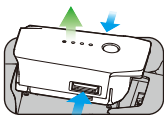

Remove Intelligent Flight Battery

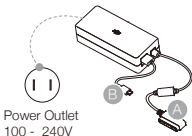

Power Outlet
100 - 240V



Charge Time:
~1 hour 20 minutes

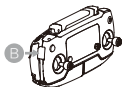

Charge Time:
~2 hours

4. Prepare the Remote Controller

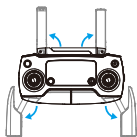

Unfold the antennas and
the mobile device clamp.



Place one end of the RC
cable to the end of the slot.

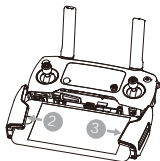

Strong



Weak



Lightning connector cable (Connected
and Standard Micro USB connector
cable included. Use as appropriate.

Optional USB Type-C connector and
Reverse Micro USB connector cables
are available.



- Choose an appropriate RC cable. Do not twist the RC cable.
- Refer to the User Manual for RC Cable connection.

5. Prepare the Aircraft



Remove the gimbal clamp from the camera



Marked



Unmarked

Match propellers to motors



Press the propeller down firmly and rotate in the lock direction



Unfold the front arms and the propellers



Unfold the rear arms and the propellers



Unfolded



- Unfold the front arms and the propellers before the rear ones. All arms and propellers must be unfolded before takeoff.
- The gimbal cover is used to protect the gimbal. Remove it when necessary.

6. Prepare for Takeoff



Power on the remote controller



Power on the aircraft



Launch the DJI GO app



Use your DJI account to activate the aircraft. Activation requires an internet connection.



- The Mavic Pro can be controlled using the Remote Controller or Virtual Joysticks. Select control modes by toggling the Control Mode Switch. Only toggle this switch when the aircraft is powered off.

7. Flight

The default flight control is known as Mode 2. The left stick controls the aircraft's altitude and heading, while the right stick controls its forward, backward, left and right movements. The gimbal dial controls the camera's tilt.

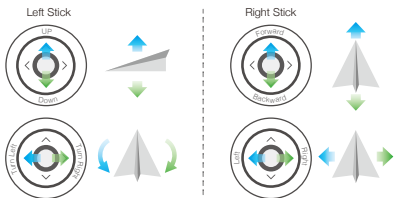

Before taking off, make sure the Aircraft Status Bar in the DJI GO app or on the Remote Controller LCD screen displays 'Ready to Go'.

Ready to Go (GPS)

READY TO GO

Combination stick command to start/stop the motors



Left stick up (slowly) to take off



Left stick down (slowly) until you touch the ground
Hold a few seconds to stop the motors



- The DJI GO app will display a landing prompt if the aircraft descends below 12in (30 cm). Pull down on the throttle or use the auto landing slider to land.
- The motors can only be stopped mid-flight when the flight controller detects critical error.

• Controlling flight with Virtual Joysticks on your mobile device via Wi-Fi



1. Toggle the Control Mode Switch to turn on Wi-Fi
2. Power on the aircraft
3. Launch the DJI GO app and tap the icon on the top right of your screen, then scan the Wi-Fi QR Code on the front arm to start connection
4. Tap Auto Takeoff
5. Fly the aircraft with touch control



- Turn on your mobile device's Wi-Fi and enter the Wi-Fi password shown on the front arm to connect to the Mavic network if for any reason you cannot scan the QR code.
- When using Wi-Fi in a wide open area with no Electro-Magnetic Interference, transmission distance is approximately 262 ft (80 m) at an altitude of 164 ft (50 m).
- The Wi-Fi frequency of your mobile device can be set to 2.4 Ghz or 5 Ghz. Set your Wi-Fi to 5 Ghz for less interference. Once connected to the Mavic Pro, you can change your Wi-Fi password or reset your Wi-Fi connection. (Refer to the User Manual for more information)

• In the DJI GO App



Auto Takeoff



Auto Landing



Return-to-Home (RTH)



ActiveTrack



TapFly



Normal



- Watch the tutorial in the DJI GO app or on the Official DJI website to learn more.
- Always set an appropriate RTH altitude before takeoff. When the aircraft is returning to the Home Point, you should guide it with the control sticks.

8. Fly Safe



Avoid flying over or near obstacles, crowds, high voltage power lines, trees or bodies of water.

DO NOT fly near strong electromagnetic sources such as power lines and base stations as it may affect the onboard compass.



DO NOT use the aircraft in adverse weather conditions such as rain, snow, fog and wind speeds exceeding 10 m/s or 22 mph.



Stay away from the rotating propellers and motors.



Learn more at:
<http://fllysafe.dji.com/no-fly>



It's important to understand basic flight guidelines, for the safety of both you and those around you. Don't forget to read the *Disclaimer and Safety Guidelines*.

MAVIC PRO