



4K MEMORY CARD CAMERA RECORDER

GY-HM200U/GY-HM200E

GY-HM170U/GY-HM170E

INSTRUCTIONS

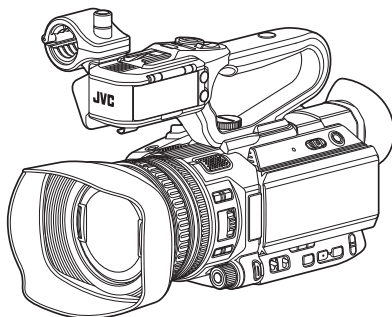

The illustration here shows how the handle unit is attached using the unit supplied with GY-HM200U/GY-HM200E.

GY-HM170U/GY-HM170E do not come with a handle unit.

The specifications and appearance of this product are subject to changes for further improvement without prior notice.

Please check the latest version of the INSTRUCTIONS from the following Mobile User Guide. You can also download the PDF from the Mobile User Guide.

Mobile User Guide

When you are outside, you can refer to the instructions from your Android phone or iPhone.

<http://manual3.jvckenwood.com/pro/mobile/global/>

You can view the Mobile User Guide using the browser on your Android phone or iPhone.



For Customer Use:

Enter below the Serial No. which is located on the body.
Retain this information for future reference.

Model No. GY-HM200U/GY-HM170U _____
Serial No. _____

Please read the following before getting started:

Thank you for purchasing this JVC product. Before operating this unit, please read the instructions carefully to ensure the best possible performance.

In this manual, each model number is described without the last letter (U/E) which means the shipping destination.
(U: for USA and Canada, E: for Europe)
Only "U" models (GY-HM200U/GY-HM170U) have been evaluated by UL.

FOR USA

These are general **IMPORTANT SAFEGUARDS** and certain items may not apply to all appliances.

IMPORTANT SAFEGUARDS

1. Read these instructions.
2. Keep these instructions.
3. Heed all warnings.
4. Follow all instructions.
5. Do not use this apparatus near water.
6. Clean only with dry cloth.
7. Do not block any ventilation openings. Install in accordance with the manufacturer's instructions.
8. Do not install near any heat sources such as radiators, heat registers, stoves, or other apparatus (including amplifiers) that produce heat.
9. Protect the power cord from being walked on or pinched particularly at plugs, convenience receptacles, and the point where they exit from the apparatus.
10. Only use attachments/accessories specified by the manufacturer.
11. Use only with the cart, stand, tripod, bracket, or table specified by the manufacturer, or sold with the apparatus. When a cart is used, use caution when moving the cart/apparatus combination to avoid injury from tip-over.
12. Unplug this apparatus during lightning storms or when unused for long periods of time.
13. Refer all servicing to qualified service personnel. Servicing is required when the apparatus has been damaged in any way, such as power-supply cord or plug is damaged, liquid has been spilled or objects have fallen into the apparatus, the apparatus has been exposed to rain or moisture, does not operate normally, or has been dropped.



CAN ICES-3 A / NMB-3 A

For USA-California Only

This product contains a CR Coin Cell Lithium Battery which contains Perchlorate Material – special handling may apply.

See www.dtsc.ca.gov/hazardouswaste/perchlorate

Safety Precautions

FOR USA AND CANADA



CAUTION

RISK OF ELECTRIC SHOCK
DO NOT OPEN



CAUTION:
TO REDUCE THE RISK OF ELECTRIC SHOCK.
DO NOT REMOVE COVER (OR BACK).
NO USER-SERVICEABLE PARTS INSIDE. REFER SERVICING TO QUALIFIED SERVICE PERSONNEL.



The lightning flash with arrowhead symbol, within an equilateral triangle is intended to alert the user to the presence of uninsulated “dangerous voltage” within the product’s enclosure that may be of sufficient magnitude to constitute a risk of electric shock to persons.



The exclamation point within an equilateral triangle is intended to alert the user to the presence of important operating and maintenance (servicing) instructions in the literature accompanying the appliance.

This device complies with Part 15 of FCC Rules. Operation is subject to the following two conditions: (1) This device may not cause harmful interference, and (2) this device must accept any interference received, including interference that may cause undesired operation.

Changes or modifications not approved by JVC could void the user’s authority to operate the equipment. This equipment has been tested and found to comply with the limits for a Class A digital device, pursuant to Part 15 of the FCC Rules. These limits are designed to provide reasonable protection against harmful interference when the equipment is operated in a commercial environment.

This equipment generates, uses, and can radiate radio frequency energy and, if not installed and used in accordance with the instructions, may cause harmful interference to radio communications. Operation of this equipment in a residential area is likely to cause harmful interference in which case the user will be required to correct the interference at his own expense.

POUR CANADA**ATTENTION**

RISQUE
D'ELECTROCUTION
NE PAS OUVRIR



ATTENTION:
POUR EVITER TOUT RISQUE
D'ELECTROCUTION NE PAS
OUVRIR LE BOITIER. AUCUNE
PIECE INTERIEURE N'EST A
REGLER PAR L'UTILISATEUR. SE
REFERER A UN AGENT QUALIFIE
EN CAS DE PROBLEME.



Le symbole de l'éclair à l'intérieur d'un triangle équilatéral est destiné à alerter l'utilisateur sur la présence d'une "tension dangereuse" non isolée dans le boîtier du produit. Cette tension est suffisante pour provoquer l'électrocution de personnes.



Le point d'exclamation à l'intérieur d'un triangle équilatéral est destiné à alerter l'utilisateur sur la présence d'opérations d'entretien importantes au sujet desquelles des renseignements se trouvent dans le manuel d'instructions.

Ces symboles ne sont utilisés qu'aux Etats-Unis.

CAUTION:

The mains plug shall remain readily operable.

- Remove the mains plug immediately if the camera functions abnormally.

WARNING:

The battery pack, the camera with battery installed, and the remote control with battery installed should not be exposed to excessive heat such as direct sunlight, fire or the like.

WARNING: TO PREVENT FIRE OR SHOCK HAZARD, DO NOT EXPOSE THIS UNIT TO RAIN OR MOISTURE.

AVERTISSEMENT : POUR EVITER LES RISQUES D'INCENDIE OU D'ELECTROCUTION, NE PAS EXPOSER L'APPAREIL A LA PLUIE NI A L'HUMIDITE.

NOTES:

- The rating plate and safety caution are on the bottom and/or the back of the main unit.
- The serial number plate is on the bottom of the unit.
- The rating information and safety caution of the AC adapter are on its upper and lower sides.

REMARQUES :

- La plaque d'identification et l'avertissement de sécurité se trouvent sous l'appareil et/ou au dos.
- La plaque du numéro de série est située sur la partie inférieure de l'appareil.
- Les informations d'identification et l'avertissement de sécurité de l'adaptateur secteur sont situés sur ses côtés supérieur et inférieur.

Caution on Replaceable lithium battery

The battery used in this device may present a fire or chemical burn hazard if mistreated.

Do not recharge, disassemble, heat above 100°C (212°F) or incinerate.

Replace battery with Panasonic, Sanyo, Sony or Maxell CR2025.

Danger of explosion or risk of fire if the battery is incorrectly replaced.

- Dispose of used battery promptly.
- Keep away from children.
- Do not disassemble and do not dispose of in fire.

When the equipment is installed in a cabinet or on a shelf, make sure that it has sufficient space on all sides to allow for ventilation (10 cm (3-15/16") or more on both sides, on top and at the rear). Do not block the ventilation holes. (If the ventilation holes are blocked by a newspaper, or cloth etc. the heat may not be able to get out.) No naked flame sources, such as lighted candles, should be placed on the apparatus. When discarding batteries, environmental problems must be considered and the local rules or laws governing the disposal of these batteries must be followed strictly.

The apparatus shall not be exposed to dripping or splashing and that no objects filled with liquids, such as vases, shall be placed on the apparatus.

Do not point the lens directly into the sun. This can cause eye injuries, as well as lead to the malfunctioning of internal circuitry. There is also a risk of fire or electric shock.

CAUTION!

The following notes concern possible physical damage to this unit and to the user.

Carrying or holding this unit by the LCD monitor can result in dropping the unit, or in a malfunction.

Do not use a tripod on unsteady or unlevel surfaces. It could tip over, causing serious damage to the unit.

CAUTION!

Connecting cables (Audio/Video, etc.) to this unit and leaving it on top of the TV is not recommended, as tripping on the cables will cause the unit to fall, resulting in damage.

When using the AC adapter in areas other than the USA

The provided AC adapter features automatic voltage selection in the AC range from 110 V to 240 V.

USING HOUSEHOLD AC PLUG ADAPTER

In case of connecting the unit's power cord to an AC wall outlet other than American National Standard C73 series type, use an AC plug adapter called a "Siemens Plug" as shown.

For this AC plug adapter, please contact the local dealers in your area.

Plug Adapter

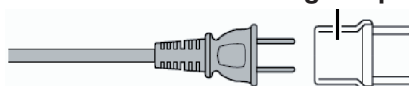

- Remove the AC adapter from the AC wall outlet when not in use.
- Do not leave dust or metal objects adhered to the AC wall outlet or AC adapter (power/DC plug).

IMPORTANT (for owners in the U.K.) Connection to the mains supply in the United Kingdom.

DO NOT cut off the mains plug from this equipment.

If the plug fitted is not suitable for the power points in your home or the cable is too short to reach a power point, then obtain an appropriate safety approved extension lead or contact the local dealers in your area.

BE SURE to replace the fuse only with an identical approved type, as originally fitted, and to replace the fuse cover.

If nonetheless the mains plug is cut off be sure to remove the fuse and dispose of the plug immediately, to avoid possible shock hazard by inadvertent connection to the mains supply.

If this product is not supplied fitted with a mains plug then follow the instructions given below:

DO NOT make any connection to the Larger Terminal coded E or Green. The wires in the mains lead are coloured in accordance with the following code:

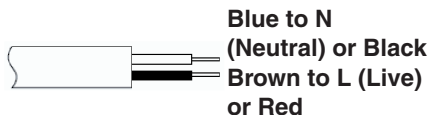

If these colours do not correspond with the terminal identifications of your plug, connect as follows:

Blue wire to terminal coded N (Neutral) or coloured black.

Brown wire to terminal coded L (Live) or coloured Red.

If in doubt — consult a competent electrician.

CAUTIONS:

- To prevent shock, do not open the cabinet. No user serviceable parts inside. Refer servicing to qualified personnel.
- When you are not using the AC adapter for a long period of time, it is recommended that you disconnect the power cord from AC outlet.

FOR EUROPE

This equipment is in conformity with the provisions and protection requirements of the corresponding European Directives. This equipment is designed for professional video appliances and can be used in the following environments:

- Controlled EMC environment (for example, purpose-built broadcasting or recording studio), and rural outdoors environments.

In order to keep the best performance and furthermore for electromagnetic compatibility we recommend to use cables not exceeding the following lengths:

Port	Cable	Length
DC	Exclusive Cable	1.8 m
USB Mini	Shielded Cable	1.2 m
AV OUT	Exclusive Cable	1.4 m
HDMI	Shielded Cable	1.8 m
REMOTE	Exclusive Cable	1 m
SDI OUT 200	Coaxial Cable	1 m
AUDIO INPUT 1/2 HDL	Shielded Cable	2 m
HEADPHONE	Exclusive Cable	2 m
AUX	Shielded Cable	3 m

The inrush current of this apparatus is 11.0 A.

CAUTION:

Where there are strong electromagnetic waves or magnetism, for example near a radio or TV transmitter, transformer, motor, etc., the picture and the sound may be disturbed. In such case, please keep the apparatus away from the sources of the disturbance.

CAUTION:

To avoid electric shock or damage to the unit, first firmly insert the small end of the power cord into the AC Adapter until it is no longer wobbly, and then plug the larger end of the power cord in to an AC outlet.

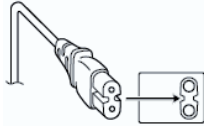
**FOR EUROPE****WARNING**

This is a Class A product. In a domestic environment this product may cause radio interference in which case the user may be required to take adequate measures.

The plastics packaging bags may cause suffocation when they are covered over the head. Tear them open, and keep them away from the reach of infants and children by ensuring that they are disposed of properly.

Dear Customer

This apparatus is in conformance with the valid European directives and standards regarding electromagnetic compatibility and electrical safety. European representative of JVC KENWOOD Corporation is: JVC Technical Services Europe GmbH
Konrad-Adenauer-Allee 1-11
61118 Bad Vilbel
Germany

Sehr geehrter Kunde, sehr geehrte Kundin, dieses Gerät stimmt mit den gültigen europäischen Richtlinien und Normen bezüglich elektromagnetischer Verträglichkeit und elektrischer Sicherheit überein.
Die europäische Vertretung für die JVC KENWOOD Corporation ist: JVC Technical Services Europe GmbH
Konrad-Adenauer-Allee 1-11
61118 Bad Vilbel
Deutschland

Battery Pack

The supplied battery pack is a lithium-ion battery. Before using the supplied battery pack or an optional battery pack, be sure to read the following cautions:

• To avoid hazards

... do not burn.

... do not short-circuit the terminals. Keep it away from metallic objects when not in use.

When transporting, carry the battery in a plastic bag.

... do not modify or disassemble.

... do not expose the battery to temperatures exceeding 60°C (140°F), as this may cause the battery to overheat, explode or catch fire.

... use only specified chargers.

• To prevent damage and prolong service life

... do not subject to unnecessary shock.

... charge within the temperature range of 10°C to 30°C (50°F to 86°F). Cooler temperatures require longer charging time, or in some cases stop charging at all. Warmer temperatures prevent complete charging, or in some cases stop charging at all.

... store in a cool, dry place. Extended exposure to high temperatures will increase natural discharge and shorten service life.

... keep a 30% battery level () if the battery pack is not to be used for a long period of time.

... remove from charger or powered unit when not in use, as some machines use current even when switched off.

... do not drop or subject to strong impact.

Terminals

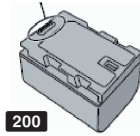

Terminals

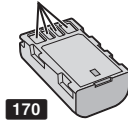

■ Para Brasil

Informação sobre eliminação de baterias

Este produto não deverá ser eliminado como lixo doméstico em geral.

Devolva a bateria velha ao comerciante ou para a rede autorizada, para que seja devolvida ao fabricante ou importador.

A reciclagem e eliminação de lixo em uma maneira adequada, ajudarão para preservar recursos, prevenindo, ao mesmo tempo, contra efeitos prejudiciais sobre a nossa saúde e o meio ambiente.

Para Retirar a Bateria Recarregável

Pressione botão e puxe a bateria para fora.

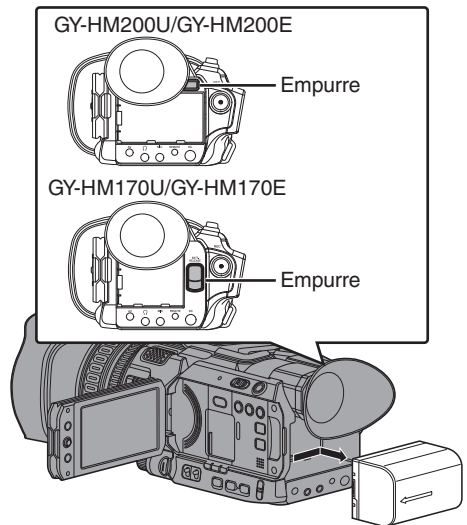

Contents

Introduction

Safety Precautions	4
Contents	10
Main Features	12
Precautions for Proper Use	14
Operation Modes	18
Names of Parts	20
Side Control Panel	21
Side Terminal Section	22
Rear Terminal	22
LCD Monitor	23
Handle Unit 200	24
Lens Section	25
Basic System Diagram	26

Preparations

Settings and Adjustments Before Use	27
Attaching the Handle Unit 200	27
Adjusting the Grip Belt	27
Attaching the External Microphone HDL	27
Attaching/Detaching the Lens Cap	28
Attaching/Detaching the Hood	28
Attaching the Tripod	29
Power Supply	29
Using a Battery Pack	29
Using AC Power (DC IN Power)	31
Power Status Display	31
Turning On/Off the Power	32
Initial Settings	33
Displays on the LCD Monitor and Viewfinder ..	35
Display Screen	35
Status Screen	36
USB Mode Screen	36
Remote Edit Mode Screen 200	36
Warning Display	36
Adjusting the LCD Monitor and Viewfinder	37
Adjusting the LCD Monitor	37
Adjusting the Viewfinder	38
Assignment of Functions to User Buttons	39
Tally Lamp	39
SD Card	40
Usable Cards	40
Formatting (Initializing) SD Cards	42
Restoring the SD Card	43
Clips Recorded to SD Cards	44
Operation Lock Feature	45

Shooting

Basic Shooting Procedures	46
Selecting System Definition, File Format and Video Format	47
Zoom Operation	49
Focus Operation	50
Adjusting the Focusing by Face Detection	53
Adjusting the Brightness	54
Adjusting the Iris	55
Setting the Gain	57
Setting the Electronic Shutter	58
Setting the ND Filter	59
Adjusting the White Balance	60
Adjusting the Camera Image	64
Using the Image Stabilizer	64
Audio Recording	65
Monitoring Audio Sound During Recording Using a Headphone	67
Time Code and User's Bit	68
Setting Time Code Generator	69
Setting the User's Bit	71
Setting Zebra Pattern	72
Viewing Recorded Videos Immediately (Clip Review)	73
Recording Simultaneously at Two Different Definitions	74
Series Rec	74
Dual Rec	74
Backup Rec	76
Special Recording	78
Pre Rec	78
Clip Continuous Rec	79
Frame Rec	80
Interval Rec	81
Splitting the Clips Freely (Clip Cutter Trig)	82

Playback

Playing Recorded Clips	83
Thumbnail Screen	83
Actions	85
Playing back	86
Deleting Clips	87
Appending/Deleting OK Mark	88
Selecting and Performing Operations on Multiple Clips	89
Selecting Multiple Clips Randomly	89
Selecting Multiple Clips Consecutively	90
Trimming Recorded Clips	91

Menu Display and Detailed Settings

Basic Operations in Menu Screen	92
Display and Description of the Menu Screen	93

Text Input with Software Keyboard	94	Configuring the Server for Downloading	146
Menu Screen Hierarchical Chart	95	Importing Metadata	147
Camera Function Menu	96	Uploading a Recorded Video Clip 200	148
User Switch Set Item	98	Configuring the FTP Server for Uploading .	148
Camera Process Menu	100	Uploading Video Clip	148
Detail/Adjust Item	102	Connecting from a Web Browser 200	150
White Balance Item	102	Editing Metadata 200	151
TC/UB Menu	103	Planning Metadata	151
LCD/VF Menu	104	Clip Metadata	152
Shooting Assist Item	105	Uploading a Recording Clip via a Web Browser	
Marker Settings Item	106	200	155
Display Settings Item	107	View Remote Feature 200	158
A/V Set Menu	109	Operating Procedure	158
Video Set Item	109	Registering/Deleting Preset Zoom	159
Audio Set Item	110	Camera Control Function 200	161
System Menu	113	Configuring Settings via a Browser 200	162
Record Set Item	114	Changing View Remote Function Settings .	163
Network/Settings Item 200	118	Changing Connection Setup	164
Adding/Editing Frequently Used Menu Items		Changing Metadata Server Settings	165
(Favorites Menu)	123	Changing Clip Server Settings	165
Adding Menu Items to Favorites Menu	123	Changing Streaming Settings	165
Editing Favorites Menu	124	Managing the Network Connection Settings File	
Display/Status Screen		200	165
Display Screen in Camera Mode	127	Saving the Connection Settings File	165
Display Screen in Media Mode	132	Reading the Connection Settings File	166
Status Screen	134	Deleting Connection Settings	167
Camera Features		Performing Live Streaming 200	167
Marker and Safety Zone Displays (Camera Mode		Setting Distribution	168
Only)	135	Starting Distribution	169
Color Bar Output	135	Others	
Configuring Setup Files	136	Error Messages and Actions	170
Saving Setup Files	136	List of FTP Transfer Errors 200	171
Loading a Setup File	137	List of Live Streaming Error Displays 200 .	173
Connecting External Devices		Blinking of the Tally Lamp	174
Connecting External Monitor	138	Warning Tone	174
Connecting the Headphone	139	Troubleshooting	174
Connecting Wired Remote Control	140	Specifications	176
Loading Clips to the PC	140	Index	180
Connecting to the Network 200		Software License Agreement	182
Functions of Network Connection 200	142	Important Notice concerning the Software	183
Preparing Network Connection 200	142		
Operating Environment	142		
Camera Setup for Network Connection	143		
Connecting via Wireless LAN	143		
Connecting via Wired LAN	145		
Connecting via Cellular Adapter	145		
Importing Metadata 200	146		
Preparing Metadata	146		

Main Features

Supports 4K high-definition recording, realizing more advanced Full HD recording quality

Recording and playback at 30p/25p/24p are possible in 4K resolution (3840x2160 pixels), which contains information that is about four times larger than Full HD. And with the H.264 codec, this camera recorder supports high resolution 4K recording at 150 Mbps and high quality HD recording at 50 Mbps 4:2:2. Even when recording scenes with a lot of movements and fine details, it is possible to record high quality videos that are smooth and rich in details.

F1.2, 29.6 mm wide-angle, 12x optical zoom lens

A new lens has been developed, which boasts top-notch brightness (maximum aperture of F1.2) for a compact handheld camera. The bright lens allows details to be reproduced clearly even in a dimly-lit room.

The 12x optical zoom supports zooming from 29.6 mm at the wide-angle end, and dynamic zoom up to 24x with the use of a high-resolution sensor (during HD/SD recording), allowing the faces of distant portrait subjects to be captured.

High-performance CMOS sensor with a sensitivity of F5.6

This camera recorder is built in with a high-performance 1/2.3-inch (effective pixels of 9.03 megapixels, 1/2.5-inch) CMOS sensor with a resolution of 12.4 megapixels, achieving a significantly enhanced sensitivity of F5.6 with the high-definition and advanced noise-reduction technology. You can produce recordings with excellent gradation even when shooting in a low-light scene or at a location where lighting cannot be used.

New-generation JVC image processor “FALCONBRID II”

The image processor employed supports both 4K codec developed by JVC and simultaneous dual stream encoding, achieving a high image quality that maximizes the potential of next-generation high-resolution sensors.

Enhanced network functions 200

An encoding bit rate higher than existing models can be set. Also, with the “Zixi” cloud service supported, which enables highly-reliable and stable data transmission, RTMP live streaming is made possible.

Supports QuickTime and AVCHD formats

Inheriting the concept of our past memory camera recorders, this camera recorder supports QuickTime (MOV) and AVCHD file formats that can be directly edited on “Final Cut Pro”, an editing software from Apple Inc.

Equipped with double SD card slots allowing various recording options

The most common SDHC/SDXC card recording system is used as the memory card. This ensures high reliability and operation at low running cost. Various user friendly recording options are available. These include series recording which enables seamless long hour continuous recordings over the slots, dual recording of the same file to two slots, and backup recording of recording only the preferred scenes to one slot using the record and stop operations while the other slot is continuously recording.

In addition, Web files with resolution suitable for distribution over the network can be created. HD files and Web files can also be recorded simultaneously.

For GY-HM200U/GY-HM200E, it is also possible to perform streaming while the recording is ongoing.

Equipped with progressive-compatible 3G-SDI and HDMI output

[SDI OUT] and [HDMI] terminals are equipped for digital output. 3G-compatible SDI output is supported, and external output including 4K from the [HDMI] terminal is possible. Uncompressed Full HD signals and audio signals can be output simultaneously from the [SDI OUT] and [HDMI] terminals.

* GY-HM170U/GY-HM170E come only with the [HDMI] terminal. [SDI OUT] terminal is not available.

3.5-inch 920K-pixel LCD display, 0.24-inch 1.56-megapixel color viewfinder

The 3.5-inch 16:9 LCD display and 0.24-inch 16:9 LCOS color viewfinder provides support for critical focusing during 4K shooting. Other assist functions are also available, including magnified focus on a manually selected point.

Auto focus/Optical image stabilizer

The camera recorder is equipped with a face detection auto focus function that covers the entire screen. Switching to manual focus is also possible. A built-in optical image stabilizer feature is also available.

Professional-style switch layout and diverse video parameters

Switches for Gain and White Balance are available on the side panel to enable quick switching according to the shooting scene. Image quality parameters such as gamma and color matrix are also available in the menu for adjustment to the preferred tones.

User button/ring assignable with different functions for greater ease of use

Menu items corresponding to each of the 9 buttons and 2 rings are available to assign the buttons and rings with different functions.

Built-in 3-position ND filter

ND filters are built into this camera recorder. You can adjust the amount of light according to the brightness during shooting by switching the 3-position ND filter (OFF, 1/4, 1/16).

Detachable handle unit with 2-channel XLR audio input terminal **200**

The handle unit is built in with recording and zoom switches, and supports microphones for business use. The recording level can also be adjusted, and connection of a phantom microphone is also supported.

* GY-HM170U/GY-HM170E does not come with the handle unit.
For details on purchasing the handle unit, please contact the local dealers in your area.

Content of this manual

Symbols used

- Caution** : Describes precautions concerning the operation of this product.
- Memo** : Describes reference information, such as functions and usage restrictions of this product.
-  : Indicates the reference page numbers and reference items.
- 200** : Feature available on GY-HM200U/GY-HM200E only.
- 170** : Feature available on GY-HM170U/GY-HM170E only.
- HDL** : Function that operates only when the handle unit is attached.

Content of this manual

- All rights reserved by JVC KENWOOD Corporation. Unauthorized duplication or reprinting of this manual, in whole or in part, is strictly prohibited.
- Illustrated designs, specifications and other contents of this manual are subject to change for improvement without prior notice.
- AVCHD Progressive and the AVCHD Progressive logo are trademarks of Panasonic Corporation and Sony Corporation.
- SDXC and SDHC logos are trademarks of SD-3C, LLC.
- HDMI (High-Definition Multimedia Interface) and  are trademarks of HDMI Licensing, LLC.
- QuickTime, Final Cut Pro, iPhone, iPad, iPod touch, iOS, Mac OS and Safari are trademarks of Apple Inc., registered in the U.S. and other countries.
- Android, Google Chrome and Nexus are trademarks and/or registered trademarks of Google Inc.
- QR Code is a registered trademark of Denso Wave Incorporated.
- Dolby and the double-D symbol are trademarks of Dolby Laboratories.
- Microsoft, Windows, Windows XP, Windows Vista, Windows 7 and Internet Explorer are either registered trademarks or trademarks of Microsoft Corporation in the United States and/or other countries.
- Surface is the trademarks of Microsoft Corporation in the United States and/or other countries.
- Mozilla and Firefox are either trademarks or registered trademarks of Mozilla Foundation in the United States and/or other countries.
- Intel Core 2 Duo is a trademark or registered trademark of Intel Corporation or its subsidiaries in the United States and other countries.
- The company name of Fontworks, Fontworks, and the name of the fonts are registered trademarks of Fontworks Inc.
- Zixi and the Zixi logo are trademarks of Zixi LCC.
- Other product and company names included in this instruction manual are trademarks and/or registered trademarks of their respective companies. Marks such as TM and ® have been omitted in this manual.

Precautions for Proper Use

Storage and Usage Locations

- Allowable ambient temperature and humidity
Be sure to use this unit within the allowable temperature range of 0 °C to 40 °C (32 °F to 104°F) and a relative humidity of 30 % to 80 %. Using this unit at a temperature or humidity outside the allowable ranges could result not only in malfunction but also serious impact on the CMOS elements as small white spots may be generated. Please exercise care during use.
- Strong electromagnetic waves or magnetism
Noise may appear in the picture or audio and/or the colors may be incorrect if this unit is used near a radio or television transmitting antenna, in places where strong magnetic fields are generated by transformers, motors, etc., or near devices emitting radio waves, such as transceivers or cellular phones.
Use of wireless microphone near this unit
When a wireless microphone or wireless microphone tuner is used near this unit during recording, the tuner could pick up noise.
- Avoid using or placing this unit in the following places.
 - Places subject to extreme heat or cold
 - Places with excessive dirt or dust
 - Places with high humidity or moisture
 - Places subject to smoke or vapor such as near a cooking stove
 - Places subject to strong vibrations or unstable surfaces
 - In a parked car under direct sunlight or near a heater for long hours
- Do not place this unit at places that are subject to radiation or X-rays, or where corrosive gases occur.
- Protect this unit from being splashed with water. (Especially when shooting in the rain)
- Protect this unit from getting wet when shooting on a beach. In addition, salt and sand may adhere to the body. Be sure to clean the unit after use.
- Protect this unit against penetration of dust when using it in a place subject to sandy dust.

Transportation

- Do not drop or hit this unit against a hard object when transporting.

Power Saving

- When this unit is not in use, be sure to set the [POWER ON/OFF] switch to "OFF" in order to reduce power consumption.

Maintenance

- Turn off the power before performing any maintenance.
- Wipe the external cabinet of the unit with a soft cloth. Do not wipe the body with benzene or thinner. Doing so may cause the surface to melt or turn cloudy. When it is extremely dirty, soak the cloth in a solution of neutral detergent, wipe the body with it, and then use a clean cloth to remove the detergent.

Rechargeable Battery

- Be sure to use only the specified batteries.
We do not guarantee the safety and performance of this device if an unspecified battery is used.
- **170**
 - Charge the battery first before using.
 - If you are not using the battery for a prolonged period of time, remove and keep the battery at a 30 % to 40 % charge level to prevent deterioration.
 - Recharge the battery to a level of 10 % to 20 % once every six months when storing the battery.
Storing the battery at a fully discharged state will result in over discharging and inability to charge the battery.
 - Store the removed battery with the battery cap attached in a dry place between 15 °C and 25 °C (59 °F and 77 °F).
- **200**
 - For details, refer to the instruction manual of the battery.

ATTENTION:



The product you have purchased is powered by a rechargeable battery that is recyclable. Please call 1-800-8-BATTERY for information on how to recycle this battery.

Regular Inspection (Maintenance)

- Under normal environment, dust will accumulate on the camera recorder when it is used over a long period. Dust may enter the camera recorder especially if it is used outdoors. This may affect the image and sound quality of the camera recorder. Check and replace the fan after every 9000 hours (suggested guideline). You can check the usage time of the fan in [System] ➔ [System Information] ➔ [Fan Hour]. (☞ P114 [Fan Hour])
If the fan is used for more than 9000 hours without replacement, "Fan Maintenance Required" will be displayed every time you turn on the power.

SDHC/SDXC Cards

- SDHC/SDXC card is referred to as SD card in this manual.
 - This camera recorder saves the recorded images and audio sound on the SD card (sold separately) in the card slot.
 - If the SD card contains files recorded by devices other than this camera recorder or files that are saved from a PC, the recordable time may be shorter or data may not be properly recorded. In addition, the remaining space on the card may not increase even when files are deleted using a PC.
 - For details on the combinations of usable SD card and format setting, refer to the following. (☞ P40 [Format Setting and Usable SD Card Combinations])
- * Using cards other than those from Panasonic, TOSHIBA or SanDisk may result in recording failure or data loss.

Handling of SD Cards

- The status indicator lights up in red when data on the SD card is being accessed.
Do not remove the SD card during data access (such as recording, playback, or formatting). Do not turn off the power or remove the battery and AC adapter during access either.
- Do not use or store the SD card in a place that is subject to static electricity or electrical noise.
- Do not place the SD card near locations that are exposed to strong magnetic fields or radio waves.
- Inserting the SD card incorrectly may result in damage of this unit or the SD card.

- We are not liable for any accidental loss of data stored on the SD card. Please back up any important data.
- Make use of the SD card within the prescribed conditions of use.
Do not use it at the following locations. Places that are subject to direct sunlight, high humidity or corrosion, places near thermal equipment, sandy or dusty places, or in a car under the sun with the doors and windows closed.
- Do not bend or drop the SD card, or subject it to strong impact or vibration.
- Do not splash the SD card with water.
- Do not dismantle or modify the SD card.
- Do not touch the terminals with your hands or with a metal object.
- Do not allow dust, dirt, water, or foreign objects to adhere to the terminals.
- Do not remove the labels or stick other labels or stickers on the SD cards.
- Do not use pencils or ballpoint pens to write on the SD cards. Always use oil-based pens.
- If you format (initialize) the SD card, all data recorded on the card, including video data and setup files, will be deleted.
- You are recommended to use cards that are formatted (initialized) on this camera recorder.
 - The SD card may be damaged if the camera recorder is not operated correctly. Formatting (Initializing) the SD card may allow it to operate correctly.
 - SD cards that have been formatted (initialized) on other cameras, computers or peripheral equipment may not operate correctly. In this case, format (initialize) the SD card on this camera recorder.
- If you want to wipe out all information by completely erasing the data, we recommend either using commercially available software that is specially designed for that purpose, or by physically destroying the SD card with a hammer, etc. When formatting or erasing data using the camera recorder, only the file administration information is changed. The data is not completely erased from the SD card.
- Some commercially available SD cards may be harder to be removed from this unit. Remove them by hooking onto the groove on the cards.
 - It will be easier to remove the cards after several times.
 - Do not stick any stickers on the cards.



- The SD card may pop out when it is being removed. Be careful not to lose the card.

Others

- Do not insert objects other than the memory card into the card slot.
- Do not block the vent on the unit. Blocking of the vent causes internal heating and may lead to burns and fires.
 - Do not turn off the [POWER ON/OFF] switch or remove the power cable during recording or playback.
 - The camera recorder may not show stable pictures for a few seconds immediately after the power is turned on, but this is not a malfunction.
 - When the video signal output terminals are not in use, put on the covers to prevent damage to the terminals.
- Do not drop this unit or subject it to strong impact or vibration as it is a precision equipment.
- Optical performance of lens
Due to the optical performance of the lens, color divergence phenomena (magnification chromatic aberration) may occur at the periphery of the image. This is not a camera malfunction.
- Noise may appear in the image when switching modes.
- If placed on its side, heat release efficiency will deteriorate.
- Use the supplied AC adapter as the power supply. Do not use the supplied AC adapter on other devices.
- When the connectors that come with connector covers are not in use, put on the covers to prevent damage to the connectors.
- This camera recorder makes use of fonts by Fontworks Inc.
- This camera recorder makes use of M+ FONTS.

LCD Monitor and Viewfinder

- The LCD monitor and viewfinder screen are manufactured using high-precision technology. Black spots may appear on the LCD monitor and viewfinder screen, or red, blue, and/or white spots may not disappear. However, this is not a malfunction and these spots are not recorded on the SD card.
- If you use this unit continuously for a long period of time, the characters displayed in the viewfinder may temporarily remain on the screen. This is not recorded on the SD card. They will not appear after you turn the power off and then on again.
- If you use this unit in a cold place, the images may appear to lag on the screen, but this is not a malfunction. Retained images are not recorded on the SD card.
- Do not press against the surface with force or subject it to strong impact. Doing so may damage or break the screens.
- Noise may appear in the viewfinder when switching between the live video and playback images.
- Due to the characteristic of the viewfinder display device, colors may appear on the images when you blink your eyes. It does not affect the recorded images, SDI output **200**, or HDMI output.

Copyright

- Any recordings made on this camera recorder that are played back for profit or public preview may infringe on the rights of the owner of the recordings.

Do not use the recordings for purpose other than personal enjoyment without prior consent from the owner.

License Notices

- MPEG LA AVC
THIS PRODUCT IS LICENSED UNDER THE AVC PATENT PORTFOLIO LICENSE FOR THE PERSONAL USE OF A CONSUMER OR OTHER USES IN WHICH IT DOES NOT RECEIVE REMUNERATION TO
(i) ENCODE VIDEO IN COMPLIANCE WITH THE AVC STANDARD (“AVC VIDEO”) AND/OR
(ii) DECODE AVC VIDEO THAT WAS ENCODED BY A CONSUMER ENGAGED IN A PERSONAL ACTIVITY AND/OR WAS OBTAINED FROM A VIDEO PROVIDER LICENSED TO PROVIDE AVC VIDEO.
NO LICENSE IS GRANTED OR SHALL BE IMPLIED FOR ANY OTHER USE. ADDITIONAL INFORMATION MAY BE OBTAINED FROM MPEG LA, L.L.C. SEE
[HTTP://WWW.MPEGLA.COM](http://WWW.MPEGLA.COM)
- MPEG LA MPEG-2 Patent
ANY USE OF THIS UNIT IN ANY MANNER OTHER THAN PERSONAL USE THAT COMPLIES WITH THE MPEG-2 STANDARD FOR ENCODING VIDEO INFORMATION FOR PACKAGED MEDIA IS EXPRESSLY PROHIBITED WITHOUT A LICENSE UNDER APPLICABLE PATENTS IN THE MPEG-2 PATENT PORTFOLIO, WHICH LICENSE IS AVAILABLE FROM MPEG LA, LLC, 6312 S. WHICH LICENSE IS AVAILABLE FROM MPEG LA, LLC, 6312 S. Fiddlers Green circle, Suite 400E, Greenwood Village, Colorado 80111 U.S.A.

Encryption in Network Connection

- Wireless LAN connections make use of an encryption function.
This encryption is designed for commercially-sold equipment, and it cannot be altered.

Operation Modes

This camera recorder has four operation modes - Camera mode, Media mode, USB mode and Remote Edit mode.

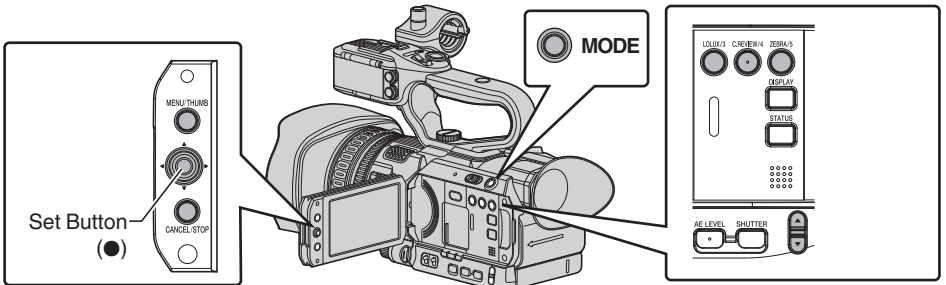
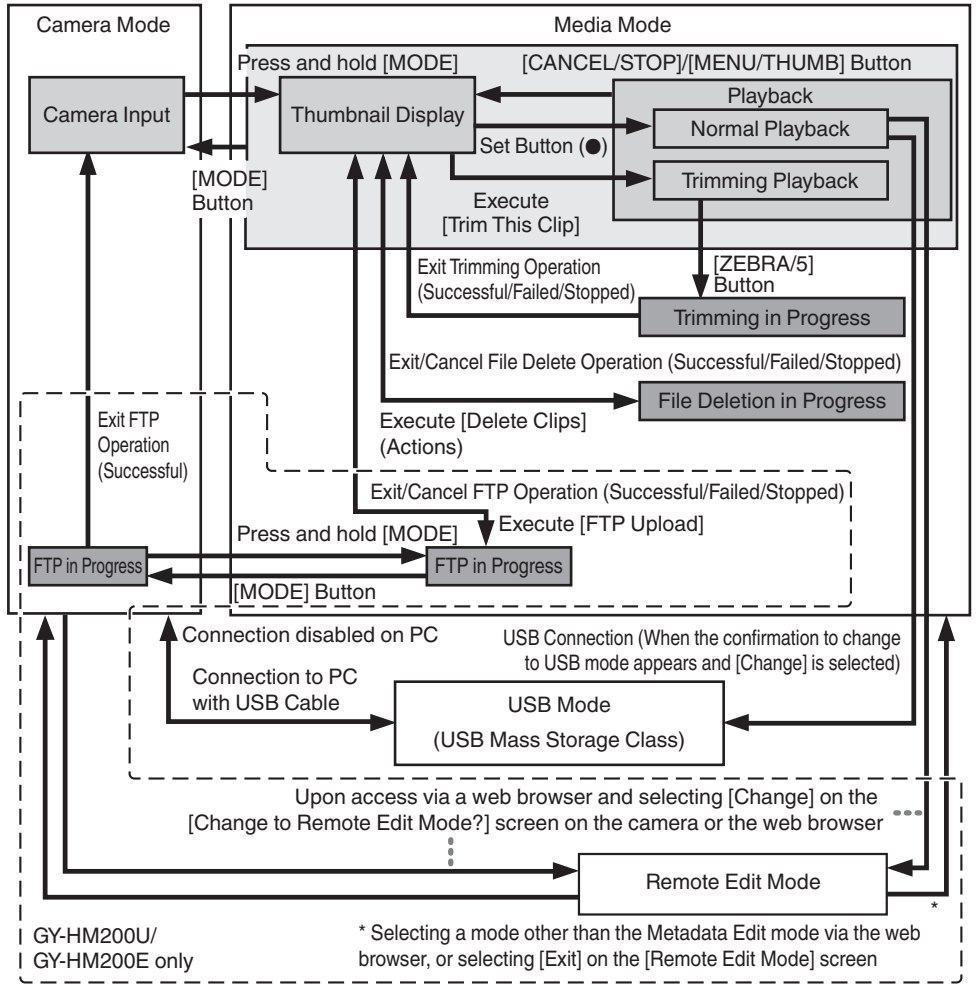

Operation Mode	Description
Camera Mode	<ul style="list-style-type: none"> • This is the camera shooting mode. The camera recorder starts up in Camera mode when the power is turned on. • Camera images are output on the viewfinder and LCD monitor. When a recordable SD card is inserted, the camera recorder enters the recording standby mode. “STBY” appears on the operation mode display area of the LCD monitor and viewfinder. • Press the [REC] trigger button to start recording. <p>Memo : _____</p> <ul style="list-style-type: none"> • Playback of SD card is not possible in Camera mode. However, you can check the most recently recorded video clip. (☞ P73 [Viewing Recorded Videos Immediately (Clip Review)])
Media Mode	<ul style="list-style-type: none"> • This mode allows you to play back or delete clips recorded on the SD card. • When a playable SD card is inserted, the thumbnail or playback screen is displayed on the viewfinder and LCD monitor. • Press and hold the [MODE] selection button to enter the Media mode when you are not shooting in the Camera mode. Once the camera recorder is in Media mode, thumbnails of the selected media slot are displayed.
USB Mode	<ul style="list-style-type: none"> • This mode allows you to connect to a PC and transfer the files on an SD card to the PC. • When the camera recorder is connected to a USB cable, the message “Change to USB Mode?” appears. Select [Change] and press the Set button to switch to USB mode. (☞ P140 [Loading Clips to the PC]) • In USB mode, the camera recorder is recognized by the connected PC as a peripheral drive. (USB mass storage class only) Disable the connection on the PC and remove the USB cable from the camera recorder to switch to Camera mode. (☞ P140 [Loading Clips to the PC]) <p>Memo : _____</p> <ul style="list-style-type: none"> • When a USB cable is connected during recording, the message appears after recording stops. • If playback is in progress, the message appears once the files are closed automatically, such as when playback stops. • Files on the PC cannot be written to the SD card.
Remote Edit Mode 200	<ul style="list-style-type: none"> • This mode enables the list display and editing of the recorded clip data through access to the clip list display page via a web browser on a smartphone, tablet terminal, or PC. • When you access via a web browser on a smartphone, tablet terminal, or PC, “It is necessary to change the camera mode to “Remote Edit Mode”. Change the mode.” appears on the web browser. Also, “Change to Remote Edit Mode?” is displayed on the display screen of the camera unit. Selecting [Change] on the camera recorder and pressing the Set button switches to the Remote Edit mode, and enables display of the clip list and editing of the clip metadata. (☞ P152 [Clip Metadata]) (☞ P155 [Uploading a Recording Clip via a Web Browser 200]) <p>Memo : _____</p> <ul style="list-style-type: none"> • If you access via a web browser on devices such as a smartphone, tablet terminal, or PC while recording is in progress, the message appears after recording stops. • If playback is in progress, the message appears once the files are closed automatically, such as when playback stops.

Names of Parts

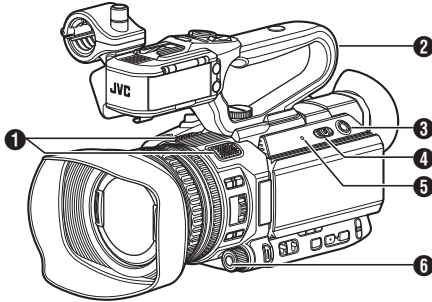

- ① Built-in Microphone
(☞ P65 [Audio Recording])
- ② Handle Unit **200**
(☞ P24 [Handle Unit **200**])
- * GY-HM170U/GY-HM170E does not come with the handle unit.
For details on purchasing the handle unit, please contact the local dealers in your area.

Memo : _____

- The handle unit is detached from the camera recorder unit in the factory shipment.
For details on attaching the handle unit, please refer to [Attaching the Handle Unit **200**] .
(☞ P27 [Attaching the Handle Unit **200**])

- ③ [MODE] Camera/Media Mode Selection Button
(☞ P18 [Operation Modes])
- ④ [POWER ON/OFF] Lock Power ON/OFF Switch
Turns ON/OFF the power.
 - Hold down the lock button (blue) in the center to toggle ON/OFF.
 - When the power is turning OFF, "P.OFF" appears on the LCD monitor and viewfinder.
 - Wait for 5 seconds or more to turn on the power again.
(☞ P32 [Turning On/Off the Power])
- ⑤ [POWER/CHARGE] Power/Charging Display Lamp
(☞ P29 [Using a Battery Pack])
- ⑥ [AWB/9] Auto White Balance/User 9 Button
 - For executing Auto White Balance and switching the registered color temperature.
(☞ P60 [Adjusting the White Balance])
 - You can also use it as a user button by assigning a specific feature in the menu setting to this button.

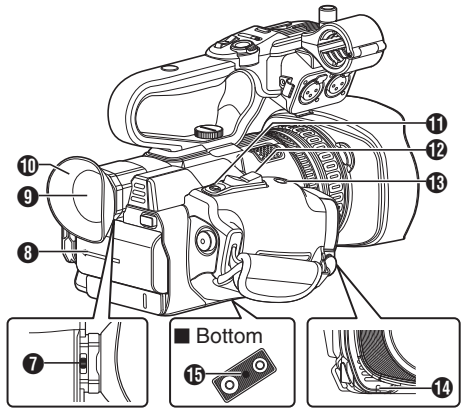

- ⑦ Visibility Adjustment Lever
(☞ P37 [Adjusting the LCD Monitor and Viewfinder])
- ⑧ Battery
(☞ P29 [Using a Battery Pack])
- ⑨ Viewfinder
(☞ P37 [Adjusting the LCD Monitor and Viewfinder])
- ⑩ Eyepiece
Prevents external light from entering the viewfinder screen and cameraman's vision.
- ⑪ [REC/7] Record Trigger Button
 - Starts/stops recording.
(☞ P46 [Basic Shooting Procedures])
 - You can also use it as a user button by assigning a specific feature in the menu setting to this button.
- ⑫ Zoom Lever at the Grip
(☞ P49 [Using the Zoom Lever at the Grip])
- ⑬ [EXPANDED FOCUS/8] Expanded Focus Assist/User 8 Button
 - For switching the expanded focus ON or OFF.
(☞ P52 [Expanded Focus Function])
 - You can also use it as a user button by assigning a specific feature in the menu setting to this button.
- ⑭ Tally Lamp
(☞ P39 [Tally Lamp])
(☞ P174 [Blinking of the Tally Lamp])
- ⑮ Tripod Mounting Hole
(☞ P29 [Attaching the Tripod])

Side Control Panel

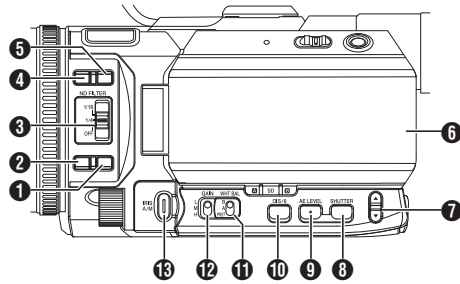

- 1** [FULL AUTO] Full Auto Selection Button
Press and hold the button to switch the Full Auto mode ON and OFF.
Full Auto mode adjusts the Iris, Gain, Shutter and White Balance automatically.
(☞ P54 [Adjusting the Brightness Automatically: Automatic Brightness Adjustment (AE) Mode])
(☞ P55 [Auto Iris (Automatic Adjustment Mode)])
(☞ P57 [Automatic Gain Mode (Automatic Gain Adjustment)])
(☞ P58 [Automatic Shutter Mode (Automatic Shutter Adjustment)])
(☞ P60 [Automatic White Balance Mode (FAW: Fulltime Auto White balance)])

Memo :

- This camera recorder is set to Full Auto mode in the factory default.
- 2** [AF/MF] Focus Selection Button
(☞ P50 [Focus Operation])
- 3** [ND FILTER] ND Filter Switch
(☞ P59 [Setting the ND Filter])
- 4** [F.ASSIST/1] Focus Assist/User 1 Button
- For switching the focus assist function ON or OFF.
(☞ P52 [Focus Assist Function])
 - You can also use it as a user button by assigning a specific feature in the menu setting to this button.
(☞ P39 [Assignment of Functions to User Buttons])
- 5** [TC/2] Time Code/User 2 Button
- Displays the time code setting screen.
(☞ P69 [Setting Time Code Generator])
 - You can also use it as a user button by assigning a specific feature in the menu setting to this button.
(☞ P39 [Assignment of Functions to User Buttons])
- 6** LCD monitor
(☞ P23 [LCD Monitor])
- 7** ▲ / ▼ Volume Buttons/[+/-] Selection Buttons
- Switches the audio monitor and adjusts the monitor speaker/headphone.
(☞ P67 [Monitoring Audio Sound During Recording Using a Headphone])
 - For switching the shutter speed and setting the automatic brightness adjustment (AE) level.
(☞ P58 [Switching Shutter Speed])
(☞ P54 [Adjusting the Brightness Automatically: Automatic Brightness Adjustment (AE) Mode])
- 8** [SHUTTER] Shutter Speed Button
For switching the shutter speed in the Manual Shutter mode. Press and hold the button to switch between Automatic Shutter mode and Manual Shutter mode.
(☞ P58 [Setting the Electronic Shutter])
- 9** [AE LEVEL] Automatic Brightness Adjustment (AE) Level Setting Button
Sets the automatic brightness adjustment (AE) level. Press and hold the button to switch between “AE Level Setting Mode” and “Recommended Fixed Level (AE: ±0)”.
(☞ P54 [Adjusting the Brightness])
- 10** [OIS/6] Optical Image Stabilizer/User 6 Button
- For switching the optical image stabilizer feature ON or OFF.
(☞ P64 [Using the Image Stabilizer])
 - You can also use it as a user button by assigning a specific feature in the menu setting to this button.
(☞ P39 [Assignment of Functions to User Buttons])
- 11** [WHT BAL B/A/PRST] White Balance Switch
(☞ P60 [Adjusting the White Balance])
- 12** [GAIN L/M/H] Gain Switch
(☞ P57 [Setting the Gain])
- 13** [IRIS A/M] Auto Iris/Manual Iris Button
(☞ P55 [Adjusting the Iris])

Side Terminal Section

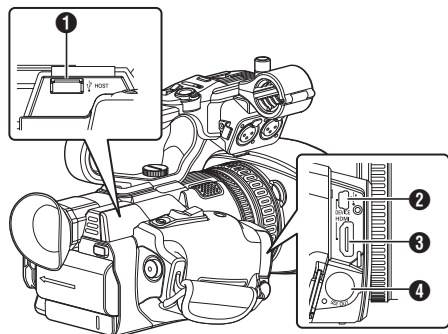

- 1 [HOST] USB Host Terminal **200**
For connecting an USB adapter according to the intended purpose when you are connecting the unit to a network.
(☞ P143 [Camera Setup for Network Connection])
- 2 [DEVICE] USB Mini Terminal
(☞ P140 [Loading Clips to the PC])
- 3 [HDMI] HDMI Output Terminal
(☞ P138 [Connecting External Monitor])
- 4 [SDI OUT] SDI Output Terminal **200**
(☞ P109 [SDI Rec Trigger **200**])
(☞ P138 [Connecting External Monitor])

Rear Terminal

GY-HM200U/GY-HM200E

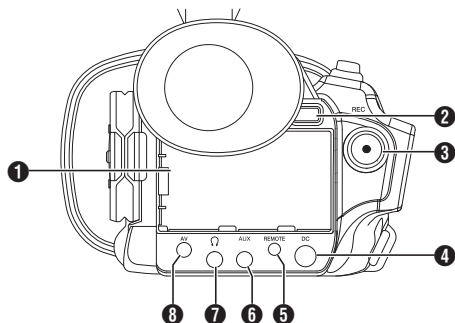

GY-HM170U/GY-HM170E

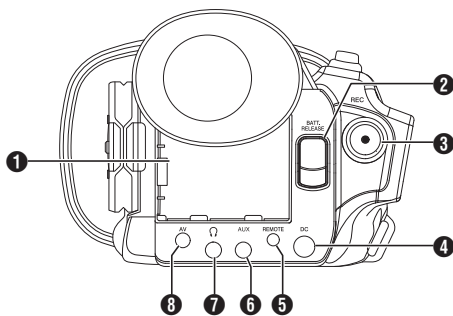

- 1 [BATTERY] Terminal
- 2 [BATT. RELEASE] Battery Lock Release Button
(☞ P30 [Removing the Battery])
- 3 [REC] Record Trigger Button
 - Starts/stops recording.
(☞ P46 [Basic Shooting Procedures])
 - You can change its function in the menu.

Memo : _____
 • This button is interlocked with the [REC/HOLD] record trigger button ④ at the top of the handle.

- 4 [DC] DC Input Terminal
Input terminal for DC 12 V power supply. For connecting with the supplied AC adapter.
(☞ P31 [Using AC Power (DC IN Power)])
- 5 [REMOTE] Remote Terminal
(☞ P140 [Connecting Wired Remote Control])
- 6 [AUX] AUX Input Terminal (Φ3.5 mm)
For connecting to receiver such as wireless microphone.
(☞ P65 [Audio Recording])
- 7 [Headphone Jack] Headphone Jack (Φ3.5 mm)
(☞ P67 [Monitoring Audio Sound During Recording Using a Headphone])
- 8 [AV] AV Output Terminal
(☞ P138 [Connecting External Monitor])

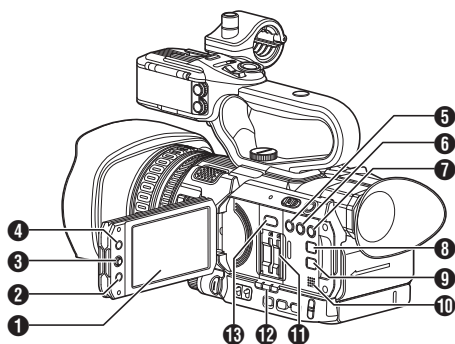

- 1** LCD Monitor
(☞ P37 [Adjusting the LCD Monitor and Viewfinder])
- 2** [CANCEL/STOP] Cancel Button
Cancels various settings and stops playback.
- 3** LCD Cross-Shaped Button (▲▼◀▶)/Set Button (●)

 - The function changes according to the operation status of the camera recorder.
 - During menu operation (all modes)
(☞ P92 [Basic Operations in Menu Screen])
 - During Camera mode
 - You can use it as a user button by assigning a specific feature in the menu setting to this button.
(☞ P39 [Assignment of Functions to User Buttons])
- 4** [MENU/THUMB] Menu/Thumbnail Button

 - Displays the menu screen during Camera mode.
 - Switches between [Main Menu] and [Favorites Menu] when the [MENU/THUMB] button is pressed and held down while the menu screen is displayed.
(☞ P92 [Basic Operations in Menu Screen])
 - Displays the menu screen when the button is pressed during thumbnail display in the Media mode.
 - Stops playback and displays the thumbnail screen when the button is pressed during playback screen display in the Media mode.
- 5** [LOLUX/3] Low-light Shooting/User 3 Button

 - For switching the low-light shooting mode ON or OFF.
 - You can also use it as a user button by assigning a specific feature in the menu setting to this button.
(☞ P39 [Assignment of Functions to User Buttons])
- 6** [C.REVIEW/4] Clip Review/User 4 Button

 - For checking the most recently captured images.
(☞ P73 [Viewing Recorded Videos Immediately (Clip Review)])
 - You can also use it as a user button by assigning a specific feature in the menu setting to this button.
(☞ P39 [Assignment of Functions to User Buttons])
- 7** [ZEBRA/5] Zebra/User 5 Button
(☞ P72 [Setting Zebra Pattern])
You can also use it as a user button by assigning a specific feature in the menu setting to this button.
(☞ P39 [Assignment of Functions to User Buttons])
- 8** [DISPLAY] Display Button

 - Press the [DISPLAY] button to switch to the display screen during normal screen display (when the menu screen is not displayed).
(☞ P35 [Display Screen])
 - Switches between [Main Menu] and [Favorites Menu] when the [DISPLAY] button is pressed while the menu screen is displayed.
(☞ P92 [Basic Operations in Menu Screen])
- 9** [STATUS] Status Screen Display Button
Press the [STATUS] button to display the status screen on the viewfinder and LCD monitor during normal screen display (when the menu screen is not displayed).
(☞ P36 [Status Screen])
- 10** Monitor Speaker
(☞ P86 [Audio Output during Playback])
- 11** SD Card Slot
(☞ P41 [Inserting an SD Card])
- 12** Card Slot A/B Status Indicator
- 13** [SLOT SEL] Card Slot Selection Button
For switching the active card slot during shooting and playback.

Handle Unit 200

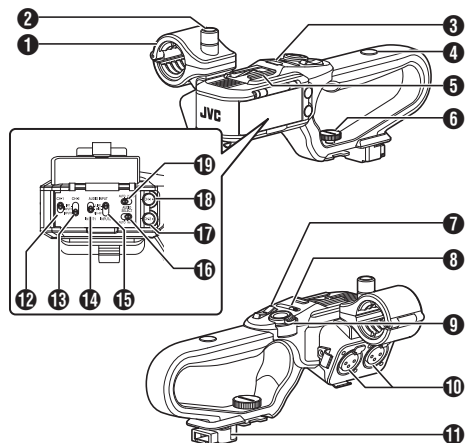

- 1 Microphone Holder
(☞ P27 [Attaching the External Microphone HDL])
- 2 Microphone Holder Lock Knob
(☞ P27 [Attaching the External Microphone HDL])
- 3 Handle Tally Lamp
(☞ P39 [Tally Lamp])
(☞ P174 [Blinking of the Tally Lamp])
- 4 Accessory Mounting Screw Hole
- 5 Shoe
For mounting separately sold lights and accessories.
- 6 Handle Unit Fastening Screw
(☞ P27 [Attaching the Handle Unit 200])
- 7 Zoom Lever on Handle
(☞ P49 [Using the Zoom Lever at the Handle HDL])
- 8 [ZOOM L/M/H] Zoom Speed Switch
(☞ P49 [Zoom Operation])
For switching the zoom speed of the zoom lever 8 at the handle.
- 9 [REC/HOLD] Record Trigger Button/Lock Switch
Starts/stops recording.
Set the switch to [HOLD] to lock the [REC] Trigger button.
- 10 [INPUT1/INPUT2] Audio Input Terminal 1, 2 (XLR 3-pin x 2)
(☞ P27 [Attaching the External Microphone HDL])
- 11 Handle Terminal
- 12 [CH1] CH1 Audio Input Signal Selection Switch
Select the audio input terminal to record to CH1.
(☞ P65 [Audio Recording])
- 13 [CH2] CH2 Audio Input Signal Selection Switch
Select the audio input terminal to record to CH2.
(☞ P65 [Audio Recording])
- 14 [INPUT1] Audio Input Signal Selection Switch
(☞ P65 [Audio Recording])
- 15 [INPUT2] Audio Input Signal Selection Switch
(☞ P65 [Audio Recording])
- 16 [CH2 AUTO/MANUAL] CH2 Audio Recording Mode Switch
(☞ P66 [Adjusting the Audio Recording Level HDL])
- 17 [CH2] CH2 Recording Level Adjustment Knob
(☞ P65 [Audio Recording])
- 18 [CH1] CH1 Recording Level Adjustment Knob
(☞ P65 [Audio Recording])
- 19 [CH1 AUTO/MANUAL] CH1 Audio Recording Mode Switch
(☞ P66 [Adjusting the Audio Recording Level HDL])

Memo : _____

- This switch is interlocked with the [REC] button 3 on the rear terminal.
- [REC] button 3 on the rear terminal is not locked.

Lens Section

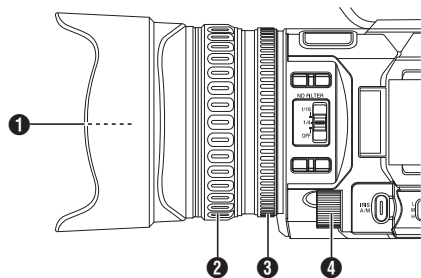





- 1 Filter Built-In Screw**
- Transparent or UV filter for lens protection, or filters for various effects can be installed.
 - Installable filter types: $\Phi 62$ mm P0.75

Memo : _____

- Remove the lens hood when installing the filter.
( P28 [Attaching/Detaching the Hood])

- 2 Focus Ring**
( P50 [Focus Operation])

- 3 Zoom Ring**
( P49 [Zoom Operation])
You can set different functions for the zoom ring and iris dial in [Main Menu] \rightarrow [Camera Function] \rightarrow [Zoom Ring].
( P97 [Zoom Ring])

- 4 Iris Dial**
( P55 [Adjusting the Iris])
You can assign the dial for “Shutter” or “AE Level” adjustment in [Main Menu] \rightarrow [Camera Function] \rightarrow [Iris Dial].
( P97 [Iris Dial])

Basic System Diagram

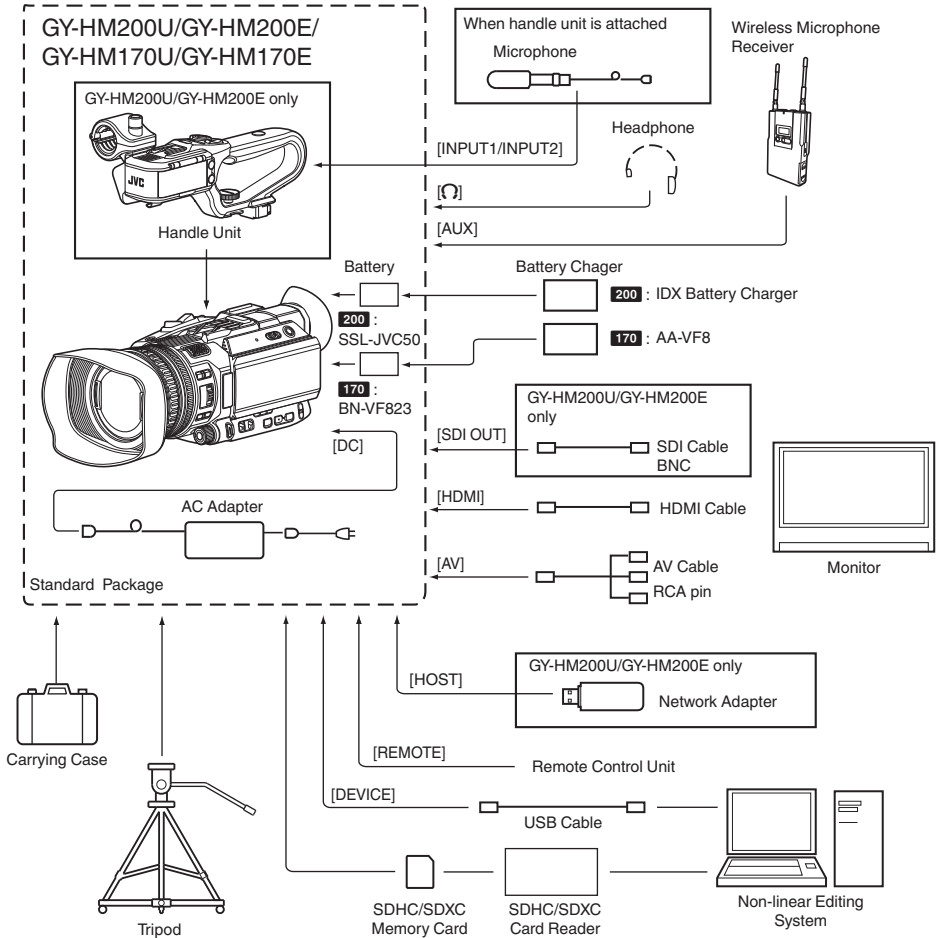

* GY-HM170U/GY-HM170E does not come with the handle unit.
 For details on purchasing the handle unit, please contact the local dealers in your area.

Settings and Adjustments Before Use

Adjusting the Grip Belt

Open the pad and adjust the position of the grip belt accordingly.

Attaching the Handle Unit 200

The handle unit is detached from the camera recorder unit in the factory shipment.

* GY-HM170U/GY-HM170E does not come with the handle unit.

For details on purchasing the handle unit, please contact the local dealers in your area.

To use the handle unit, attach it by following the steps below.

* Attach or detach the handle unit when the power is turned off.

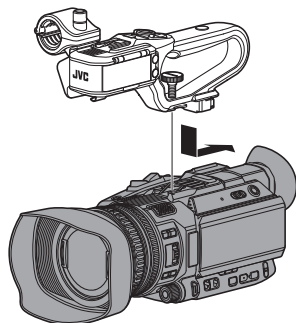

1 Fit the handle terminal at the bottom of the handle unit to the handle unit mount at the top of the camera recorder.

- Fit the handle unit carefully, paying attention not to damage the terminals at the bottom of the unit.

2 Slide the handle unit in the direction indicated by the arrow to attach it to the hot shoe of the camera recorder.

3 Press the screw on the handle unit and turn it in the clockwise direction. Tighten it securely to fasten the unit to the camera recorder.

- The handle unit may be unsteady if the screw is not securely fastened, and may fall off during use.

Caution : _____

- Attach or detach the handle unit when the power is turned off. Doing so when the power is turned on can result in malfunction.

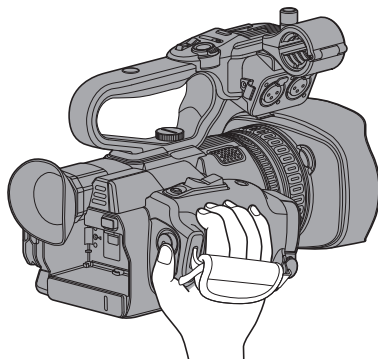

Caution : _____

- If the grip is loose, the camera recorder may fall off resulting in injuries or malfunction.

Attaching the External Microphone HDL

You can attach a separately sold microphone to the microphone holder.

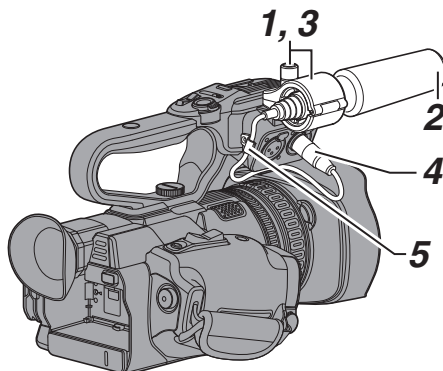

1 Turn the knob on the microphone holder counterclockwise to loosen and open the microphone holder.

2 Place the microphone in the microphone holder.

3 Turn the knob on the microphone holder clockwise to secure the microphone.

4 Connect the microphone cable to the [INPUT1] or [INPUT2] terminal.

5 Pin the microphone cable to the clamp.

6 Perform the settings for the microphone correctly.

( P65 [Audio Recording])

Attaching/Detaching the Lens Cap

- Before shooting, detach the lens cap.
- When this camera recorder is not in use, attach the lens cap to protect the lens.
- Pinch the tabs on both sides of the lens cap to attach and detach the lens cap.

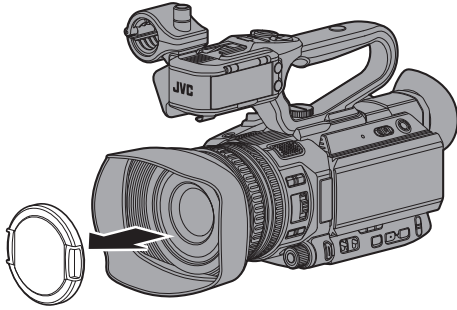

Caution :

- Do not press against the lens cap with force. Doing so may damage the lens or the cap.

Attaching/Detaching the Hood

Attaching the Hood

Align the markings on the camera recorder and hood; turn the hood in the direction of the arrow (clockwise) until it is locked.

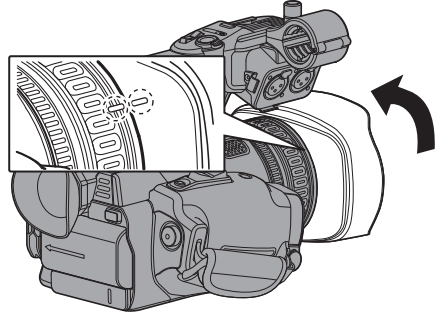

Detaching the Hood

- To detach the hood, turn the hood in the direction opposite to attaching it (counterclockwise).

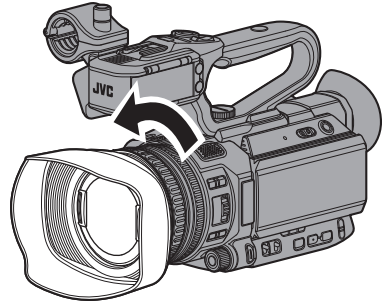

Caution :

- Remove the hood when attaching a filter, teleconverter or wide converter to the front of the lens.

Attaching the Tripod

Use the screw hole at the bottom of this camera recorder.

(3/8×16UNC, 1/4×20UNC)

Use the screw hole that suits the tripod.

To prevent the camera recorder from falling off, which may result in injuries or damages, read the instruction manual of the tripod to be used and make sure that it is securely attached.

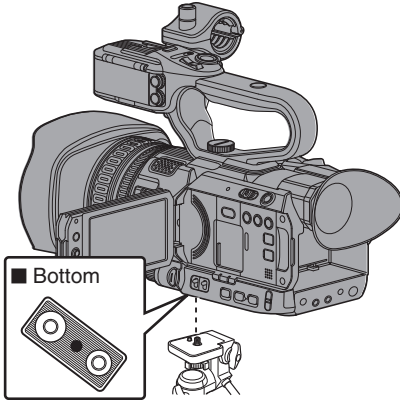

Caution :

- Use the tripod on a stable surface.
- To prevent the camera recorder from falling, attach securely using the rotation prevention hole.
- Use screws with screw length 5 mm and below.

Power Supply

To use this camera recorder, you can attach a battery pack or connect an AC adapter to it.

(☞ P29 [Using a Battery Pack])

(☞ P31 [Using AC Power (DC IN Power)])

Caution :

- Set the [POWER ON/OFF] switch to "OFF" before changing the power supply that operates this camera recorder.

Using a Battery Pack

Charging the Battery

Charge the battery immediately after purchase or when the battery power is running low.

* The battery is not charged when purchased.

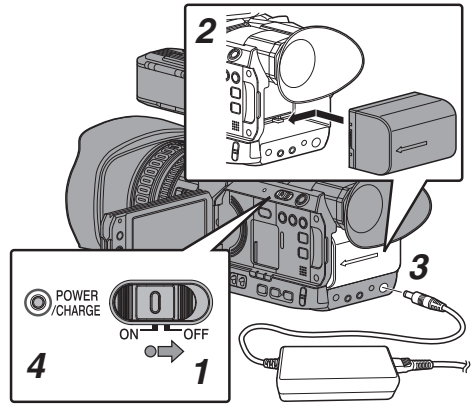

- 1 Hold down the lock button (blue) at the center of the [POWER ON/OFF] switch to set to "OFF".**
- 2 Attach the supplied battery.**
Slide it in until you hear a click.
- 3 Connect the supplied AC adapter to the [DC] terminal.**
Open the cover of the [DC] terminal and connect as shown in the diagram.
- 4 Connect the AC adapter to a power outlet.**
 - The [POWER/CHARGE] lamp blinks during charging and will go out after charging is complete.
 - Remove the AC adapter after charging is complete.

Memo :

- Blinking of the [POWER/CHARGE] lamp during charging indicates the charge level.

[POWER/CHARGE] Lamp	Charge Level
Alternates between a blinking orange light (4 times) and light off (1 second)	Less than 25 %
Alternates between a blinking orange light (3 times) and light off (1 second)	Less than 50 %
Alternates between a blinking orange light (2 times) and light off (1 second)	Less than 75 %
Alternates between a blinking orange light (blinks once) and light off (1 second)	Less than 100 %
Light goes out	Fully charged

- You can charge the battery even when operating the camera recorder using the AC adapter.

Removing the Battery

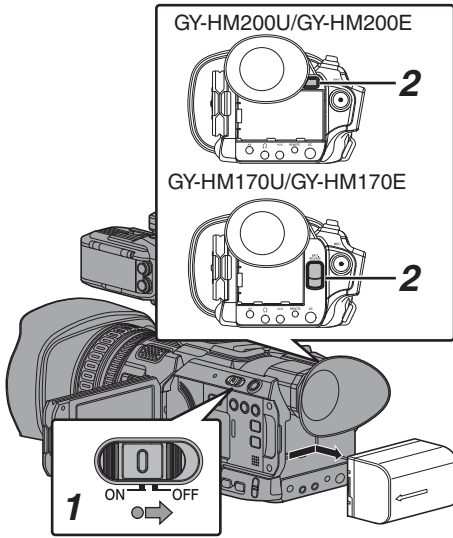

- 1 Hold down the lock button (blue) at the center of the [POWER ON/OFF] switch to set to "OFF".
- 2 While pressing and holding the [BATT. RELEASE] button, push up and remove the battery in the direction of the arrow.

Caution :

- Do not remove the battery when the [POWER ON/OFF] switch is "ON".
- Do not insert or remove the DC cable when the battery is in use.
- Leaving the camera recorder unused with the battery inside will deplete the battery power even if you set the [POWER ON/OFF] switch to "OFF". Remove the battery if you are not using the camera recorder.

Estimated Charging and Continuous Operating Times

■ Charging time

SSL-JVC50 (accessory) **200** : Approx. 4 hrs
 BN-VF823 (accessory) **170** : Approx. 3 hrs

* When the [POWER ON/OFF] switch is set to "OFF"

Memo : _____

■ 170

- If you charge the battery immediately after using while the battery is still warm, it may not be fully charged.
- It is recommended that you charge the battery in an environment between 10 °C and 30 °C (50 °F and 86 °F). The battery may not be fully charged or the charging time may be prolonged if charged under low temperatures (below 10 °C/ 50 °F). In addition, charging the battery under high temperature (above 30 °C/86 °F) condition may shorten the battery life.

■ 200

- For details, refer to the instruction manual of the battery.

■ Continuous operating time

SSL-JVC50 (accessory) : Approx. 4 hrs 40 mins (*1)

200

Approx. 5 hrs (*2)

BN-VF823 (accessory) : Approx. 2 hrs (*1)

170

Approx. 2 hrs 20 mins (*2)

- *1 When [System] is set to "4K" and all other settings are in factory default
- *2 When [System] is set to "HD" and all other settings are in factory default

Memo : _____

- Actual operating times may differ depending on the age of the battery, charging condition, and operating environment.
- Operating time is shortened in cold environment.
- The operating time may shorten when power zoom is used, accessories are connected, or when the LCD monitor is frequently used.
- For purchase of spare batteries and battery charger, please contact the local dealers in your area.

Precautions for Batteries

- Store the battery in a cool and dry place when not in use. Do not expose the battery to high temperatures (such as in a car under direct sunlight). Failure to do so not only shortens the battery life but also damages the battery.
- If the operating time shortens drastically even after charging, the battery may be reaching the end of its life. Replace the battery with a new one.

Using AC Power (DC IN Power)

Use the supplied AC adapter to operate the camera recorder with AC power.

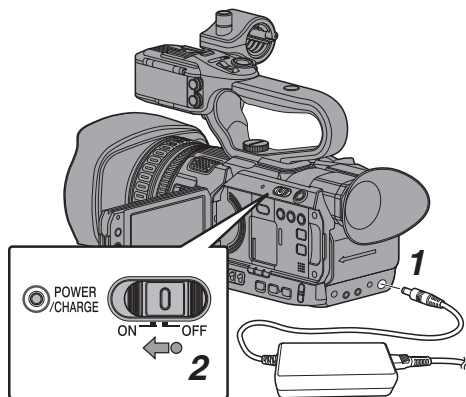

1 Connect the DC cable of the AC adapter to the [DC] terminal of the camera recorder.

- Check that the power switch of the camera recorder is set to “OFF”.
- Open the cover of the [DC] terminal and connect as shown in the diagram.

2 Hold down the lock button (blue) at the center of the [POWER ON/OFF] switch to set to “ON”.

Power will be supplied to the camera recorder.

Caution :

- Do not insert or remove the DC cable during recording.
- Do not use power supply of high voltage fluctuation, containing noise such as ripple, or with insufficient capacity.

Charging the Built-In Battery

- The date/time and time code data are stored using the built-in rechargeable battery.
- When power is connected to the camera recorder, the built-in battery always gets charged. When the power is disconnected, the battery gradually discharges.
- The battery will be totally discharged if left unused for 3 months and the date/time and time code data will be reset. When this happens, set the [POWER ON/OFF] switch to “ON” to display the [Initial Setting] screen, then set the date/ time.

(P33 [Initial Settings])

Power Status Display

Viewfinder Screen and LCD Monitor

The power status is displayed on the display and menu screens.

Display	Description
7.4V 100min 30% RES	Currently powered by a battery. When the battery power runs out, the battery mark appears hollow, and “RES” (yellow) is displayed. Memo : _____ • You can set the display using [LCD/VF] → [Display Settings] → [Battery]. (P107 [Battery])
	Acquisition of battery information may fail if a genuine battery is not used.
	Appears when an error occurs during battery charging.
	Currently powered by an AC adapter.
	Camera recorder battery charging in progress. (P108 [Details on charging condition])

Memo : _____

- If the supplied battery (or equivalent battery sold separately) is not used, the battery mark which indicates the battery level may not appear.

Display Screen

(P127 [Display Screen in Camera Mode])
 (P132 [Display Screen in Media Mode])

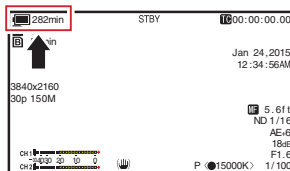

Menu Screen

(☞ P93 [Display and Description of the Menu Screen])

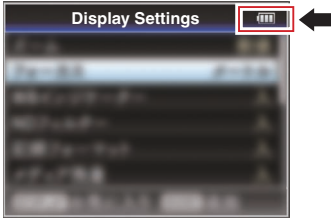

- If the battery is not fully charged, the battery will be charged at the same time.
- Even when a fully charged battery is used, charge the battery briefly to confirm the remaining battery power.
(☞ P29 [Power Supply])
(☞ P31 [Power Status Display])

Warnings by Lamp and Warning Tone

Warning status is indicated by tally lamp and warning tone.

- The tally lamp blinks.
- Setting [Main Menu] → [A/V Set] → [Audio Set] → [Alarm Level] to “High” or “Low” sounds the warning tone.
The warning tone is output from the monitor speaker or [Ⓜ] terminal.
(☞ P112 [Alarm Level])

Memo : _____

- In the event that the battery level runs low while it is being used, the camera recorder will stop operating automatically.

Caution : _____

- The remaining battery power and time are displayed as they are from the battery information. Accurate data may not be displayed depending on the battery condition. Replace the battery as soon as possible when the remaining battery power and time are low.

Turning On/Off the Power

Turning On the Power

- 1 **Hold down the lock button (blue) at the center of the [POWER ON/OFF] switch to set to “ON”.**

The camera recorder starts up in Camera mode and is ready for shooting.

Memo : _____

- The camera recorder always start up in Camera mode when the [POWER ON/OFF] switch is set to “ON”. Use the [MODE] button at the side of the camera recorder to switch mode.
(☞ P18 [Operation Modes])

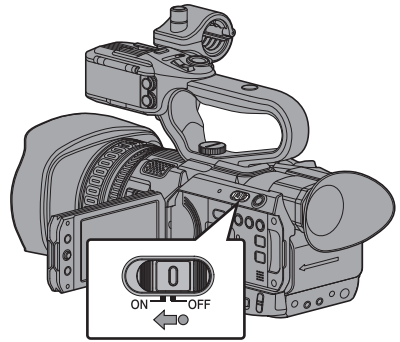

Turning Off the Power

Sets the camera recorder to the recording standby or stop mode.

- 1 **Hold down the lock button (blue) at the center of the [POWER ON/OFF] switch to set to “OFF”.**
- 2 **Remove the battery and the power to the [DC] terminal (when not in use for a long time).**

Caution : _____

- Do not set the [POWER ON/OFF] switch to “OFF” during recording. Check that the operation mode display is “STBY” or “STOP” before you turn off the power.
- If you have mistakenly set the [POWER ON/OFF] switch to “OFF” during recording, wait for 5 seconds or more before you turn on the power again.
- When turning off the power, first set the [POWER ON/OFF] switch of the camera recorder to “OFF”. Do not remove the battery or turn off the AC power while the [POWER ON/OFF] switch is set to “ON”.

Initial Settings

When the power is first turned on, the Initial Setting screen for performing the initial settings in the camera recorder appears.

Set the date/time of the built-in clock in the [Initial Setting] screen.

All operations are disabled until initial settings are complete.

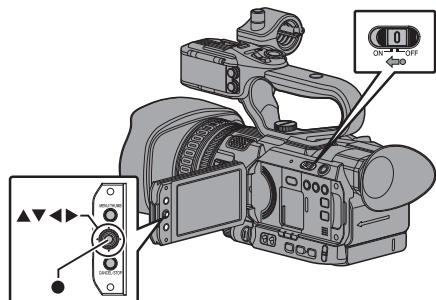

Memo : _____

- It is recommended to use the AC adapter as the power supply.
- Attach the lens cap.

1 Hold down the lock button (blue) at the center of the [POWER ON/OFF] switch to set to "ON".

A language selection screen appears.

- For U models

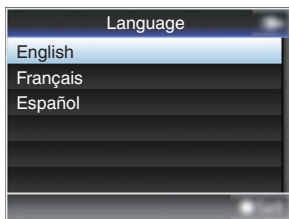

- For E models

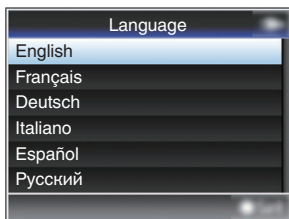

Memo : _____

- The menus and messages on the screen of the LCD monitor or viewfinder are displayed in the selected language.

2 Select a language using the cross-shaped button (▲▼), and press the Set button (●).

The Initial Setting screen appears.

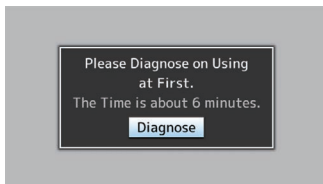

3 Ensure the lens cap is attached, and press the Set button (●).

- Self-diagnosis starts.
- A progress bar appears, and "Complete Diagnosis" appears when the diagnosis is complete.

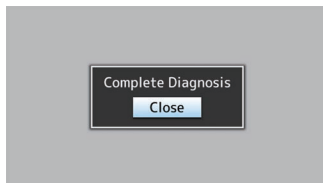
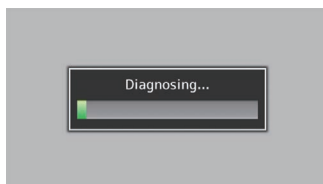

Memo : _____

- It takes about 6 minutes to complete the diagnosis. During the diagnosis, do not operate or turn off the camera recorder.

4 Press the Set button (●) after confirming the exit screen.

The [Initial Setting] screen appears.

- For U models

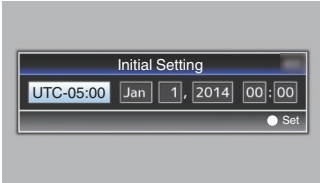

- For E models

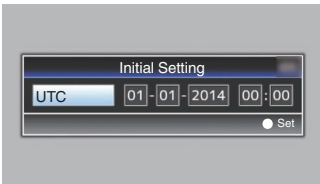

Memo : _____

- The [Initial Setting] screen appears when the power is turned on for the first time and when the power is turned on after the built-in battery is fully discharged.
- The configured date/time data is saved in the built-in rechargeable battery even if the power is turned off.

5 Set the time zone and date/time.

- ① Move the cursor with the cross-shaped button (◀▶) and select the setting item.
- ② Change the values with the cross-shaped button (▲▼).

6 Press the Set button (●) after setting is complete.

The clock is set to 0 seconds of the input date/time.

Memo : _____

- The configured date/time data can be displayed on the LCD monitor and viewfinder and be recorded to the SD card.
- The value of the year can be set in the range of “2000” to “2099”.

Changing the Time after Initial Setting

Setting the Date/Time

(☞ P114 [Date/Time])

1 Select [System] → [Date/Time].

The [Date/Time] screen appears.

2 Set the date and time.

- ① Move the cursor with the cross-shaped button (◀▶) and select the setting item.
- ② Change the values with the cross-shaped button (▲▼).

3 Press the Set button (●) after setting is complete.

The clock is set to 0 seconds of the input date/time.

Changing the Display Style

You can change the display style of the date/time on the menu.

Setting the Date Display (Date Style)

(☞ P108 [Date Style])

The date display can be changed in [LCD/VF] → [Display Settings] → [Date Style].

Setting the Time Display (Time Style)

(☞ P108 [Time Style])

The time display can be changed in [LCD/VF] → [Display Settings] → [Time Style].

Date/Time Display in Each Operation Mode

During Camera mode:

Date/time of the built-in clock is displayed.

During Media mode:

Shooting date/time of the clip being played back is displayed.

Displays on the LCD Monitor and Viewfinder

You can display the camera status, media information, zebra pattern, and various markers in the video image on the LCD monitor and viewfinder screen during shooting.

Memo : _____

- When [Main Menu] → [A/V Set] → [Video Set] → [Display On TV] is set to "On", the display screen and menu screen are also displayed in the video image from the video signal output terminal.
(☞ P109 [Display On TV])

Display Screen

Display Screen (VF/LCD) in Camera Mode

(☞ P127 [Display Screen in Camera Mode])

- The display switches between three screen types with every press of the [DISPLAY] button.
(Display 0 → 1 → 2 → 0)
- Press the [STATUS] button to switch to the status screen.

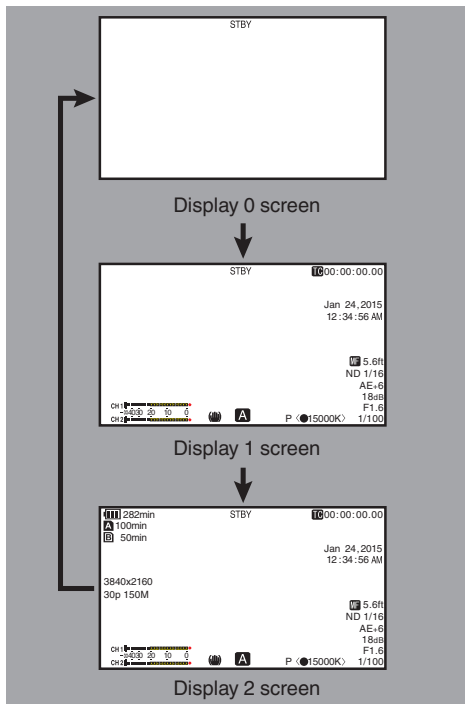

Display Screen (VF/LCD) in Media Mode

(☞ P132 [Display Screen in Media Mode])

- This is the screen display during clip playback in Media Mode.
- The display switches between three screen types with every press of the [DISPLAY] button.
(Display 0 → 1 → 2 → 0)

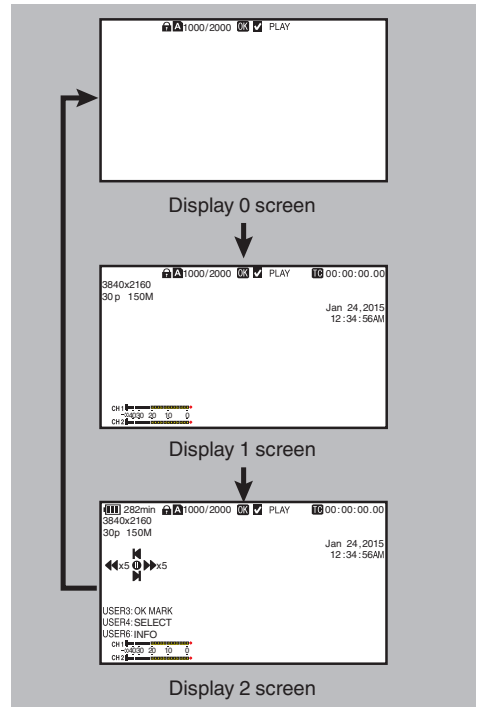

Status Screen

- This screen allows you to check the current settings.
- To display the status screen, press the [STATUS] button in the normal screen.
- The status display differs according to the operation mode (two types). (☞ P18 [Operation Modes])
- Press the [STATUS] button to switch to the display screen.
- Press the [MENU] button at each status screen (other than the [Camera 1] screen) to enter the setting screen.
- Use the cross-shaped button (◀▶) to switch screens as follows:

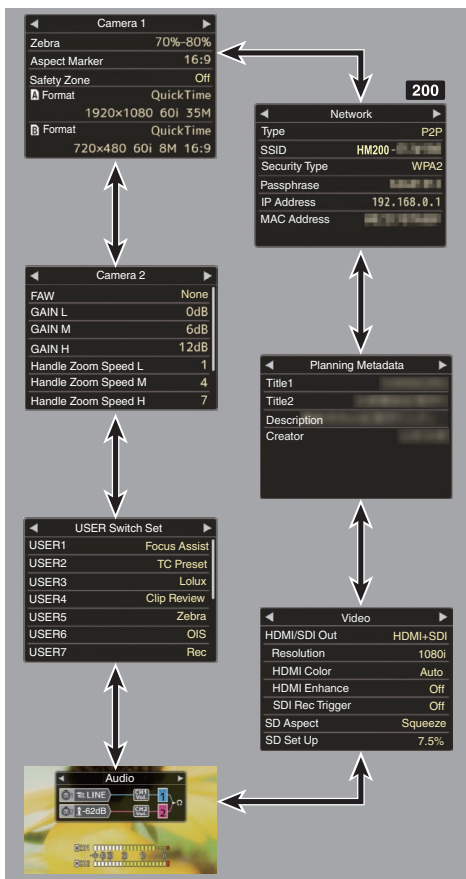

USB Mode Screen

This screen displays the USB mode.

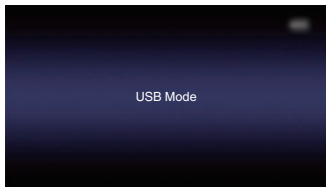

Remote Edit Mode Screen 200

This is a mode for accessing the page for editing the metadata that is recorded in a clip via a web browser on devices such as a smartphone, tablet terminal, or PC.

(☞ P152 [Clip Metadata])

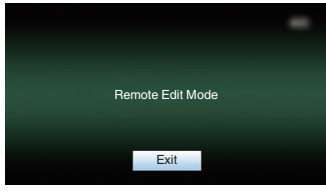

Warning Display

Warning display is displayed in the display screen (Camera mode, Media mode).

(☞ P170 [Error Messages and Actions])

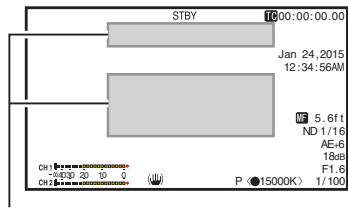

Warning Display Area

* These are screen examples of GY-HM200U/GY-HM200E. The contents displayed are different depending on the model and settings.

Adjusting the LCD Monitor and Viewfinder

You can monitor video images on this camera recorder using the viewfinder, LCD monitor, or both.

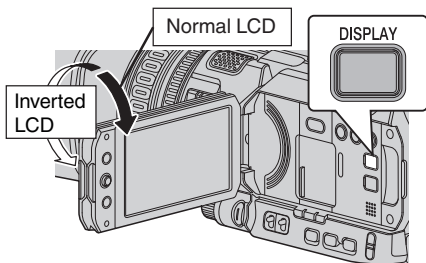

Displays on the LCD Monitor and Viewfinder Screen (VF)

[VF SW] Item	State of Viewfinder	LCD Screen	Viewfinder Screen	
		LCD Monitor Open	LCD Monitor Open	LCD Monitor Closed
Enable	Pulled out	ON	ON	ON
Enable	Retracted	ON	OFF	ON
Disable	-	ON	ON	ON

ON: Display on, OFF: Display off

- “LCD Monitor Open” includes the state when the LCD display is inverted.
- “LCD Monitor Closed” indicates the state when there is no display on the LCD monitor.

Memo :

- Press and hold the [DISPLAY] button for 2 seconds to turn ON/OFF the LCD monitor.
- The function to switch between LCD monitor and viewfinder displays by pressing the [DISPLAY] button can be canceled by opening/closing or rotating the LCD monitor.
- When [LCD/VF] → [VF SW] is set to “Enable”, it is necessary to pull out the viewfinder in order to display the images on the viewfinder. (☞ P104 [VF SW])

* When [LCD/VF] → [VF SW] is set to “Enable”, images will be displayed on the viewfinder if the viewfinder is pulled out, regardless of the state of the LCD monitor.

(☞ P104 [VF SW])

Adjusting the LCD Monitor

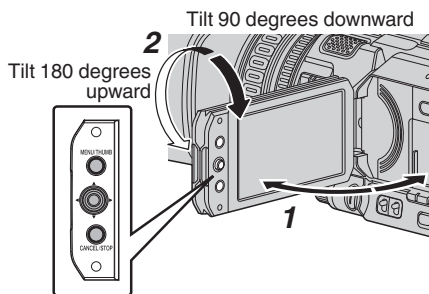

- 1 **Open the LCD cover.**
- 2 **Incline the LCD monitor to a position that enables easy viewing.**

Rotate the LCD monitor to adjust the angle.

- While the LCD monitor is open, you can rotate it 180 degrees upward or 90 degrees downward.
- Rotating the LCD monitor 180 degrees upward enables you to see the screen from the lens side. To display the image when it is viewed from the opposite direction (mirror image), perform setting as follows. Set [Main Menu] → [LCD/VF] → [LCD Mirror] to “Mirror” → Set button (●) (☞ P105 [LCD Mirror])

- 3 **Adjust the brightness, contour, and contrast of the LCD monitor.**

You can change the angle and brightness of the LCD monitor according to your usage condition. Changing the brightness of the screen will not affect the recorded images.

- Use the [LCD Bright] menu to adjust the brightness of the LCD monitor. [Main Menu] → [LCD/VF] → [LCD Bright] (☞ P105 [LCD Bright])
- Use the [LCD/VF Peaking] menu to adjust the contour of the LCD monitor. (The contour of the viewfinder screen will also be adjusted at the same time.) [Main Menu] → [LCD/VF] → [LCD/VF Peaking] (☞ P105 [LCD/VF Peaking])
- Use the [LCD Contrast] menu to adjust the contrast of the LCD monitor. [Main Menu] → [LCD/VF] → [LCD Contrast] (☞ P105 [LCD Contrast])

Adjusting the Viewfinder

You can change the brightness and peaking of the viewfinder screen according to your usage conditions.

Changing the brightness of the screen will not affect the recorded images.

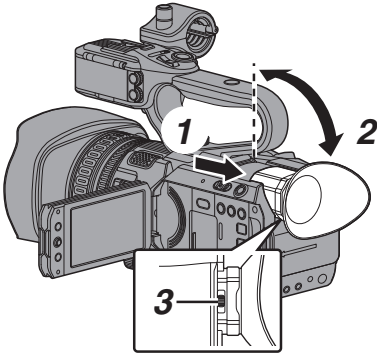

Caution : _____

- A high-definition viewfinder is used on this camera recorder in order to provide an accurate focusing environment. Due to the characteristic of the display device, colors may appear on the images when you blink your eyes. This is not a malfunction. It does not affect the recorded images, SDI output **200**, AV output, or HDMI output.

- 1 Pull out the viewfinder.**
- 2 Incline the viewfinder vertically to a position that enables easy viewing.**
- 3 Adjust the visibility using the visibility adjustment lever.**
Adjust the visibility adjustment lever to sharpen the image on the viewfinder screen.

4 Adjust the brightness, contour, and contrast of the viewfinder screen.

- Use the [VF Bright] menu to adjust the brightness of the viewfinder screen.
[Main Menu] → [LCD/VF] → [VF Bright]
(☞ P105 [VF Bright])
- Use the [LCD/VF Peaking] menu to adjust the contour of the viewfinder.
(The contour of the LCD monitor will also be adjusted at the same time.)
[Main Menu] → [LCD/VF] → [LCD/VF Peaking]
(☞ P105 [LCD/VF Peaking])
- Use the [VF Contrast] menu to adjust the contrast of the viewfinder screen.
[Main Menu] → [LCD/VF] → [VF Contrast]
(☞ P105 [VF Contrast])

Memo : _____

- If [Main Menu] → [LCD/VF] → [VF SW] is set to "Enable", pull out the viewfinder before making any adjustment.
(☞ P104 [VF SW])

Displaying in Black and White

You can display the viewfinder screen in black and white.

- [Main Menu] → [LCD/VF] → [VF Color] item
→ Press Set button (●) → Select "Off" →
Press Set button (●).
(☞ P104 [VF Color])

Assignment of Functions to User Buttons

You can assign functions to the following buttons and use them as user buttons. By assigning functions to the buttons, the usability of the camera recorder can be enhanced. Perform settings in the menu items corresponding to each button.

Button	Menu Item
[F.ASSIST/1] Button	[USER1]
[TC/2] Button	[USER2]
[LOLUX/3] Button	[USER3]
[C.REVIEW/4] Button	[USER4]
[ZEBRA/5] Button	[USER5]
[OIS/6] Button	[USER6]
[REC/7] Button	[USER7]
[EXPANDED FOCUS/8] Button	[USER8]
[AWB/9] Button	[USER9]
LCD Cross-Shaped Button (▲)	[LCD KEY▲]
LCD Cross-Shaped Button (▼)	[LCD KEY▼]
LCD Cross-Shaped Button (◀)	[LCD KEY◀]
LCD Cross-Shaped Button (▶)	[LCD KEY▶]

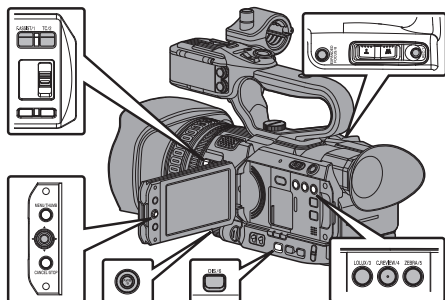

- 1 Assign functions to the buttons from the menu.**
Specify each item in [Main Menu] → [Camera Function] → [User Switch Set] → [USER1]-[USER9], [LCD KEY▲], [LCD KEY▶], [LCD KEY▼], [LCD KEY◀].
(☞ P98 [User Switch Set Item])

Memo : _____

- Operations of the user buttons are interlocked with the menu settings.
- When the menu screen is displayed, these buttons function as the menu operation buttons. (☞ P92 [Basic Operations in Menu Screen])

Tally Lamp

This is the indicator lamp for recording and warning. The operation changes according to the menu settings. The lamp blinks when the battery or remaining space on the SD card is low. (Camera mode only)
* Specify the setting in [Main Menu] → [System] → [Tally Lamp].
(☞ P113 [Tally Lamp])

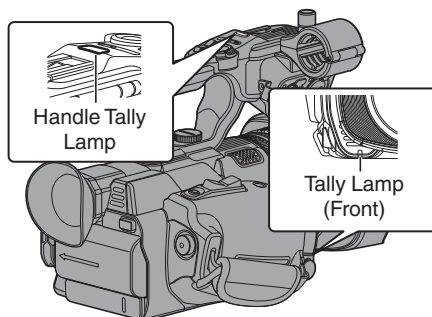

Menu setting	[Tally Lamp]	Off	On
Functional information	Warning	-	▲
	Caution	-	■
Recording status	Recording	-	●
	Special recording *	-	●

- : Lights up
 - ▲ : Blinks four times in 1 second
 - : Blinks once in 1 second
- * Paused state during special recording ([Clip Continuous]).
(☞ P79 [Clip Continuous Rec])

Memo : _____

- Blinking takes priority over lighting up.

SD Card

This camera recorder saves the recorded images and audio sound on the SD card (sold separately) in the card slot.

Usable Cards

Format Setting and Usable SD Card Combinations

System	Format	Bit Rate	Usable SD Card
4K	-	-	UHS-I U3 or higher
HD	QuickTime	50M (YUV422), 50M (XHQ)	Class 10 or higher
		35M (UHQ)	Class 6 or higher
	AVCHD	-	Class 4 or higher
SD	-	-	
Web	-	-	

Caution :

- Using cards other than those from Panasonic, TOSHIBA or SanDisk may result in recording failure or data loss.
- If an UHS-I card with no classification indication is used, it may not be possible to perform HD recording.

Estimated Recordable Time of SD Cards

The estimated recordable time is only a guide. Differences may occur depending on the SD card in use and the battery condition.

- ☞ P115 [A Resolution]
- ☞ P116 [B Resolution]
- ☞ P115 [A Frame Rate]
- ☞ P116 [B Frame Rate]
- ☞ P115 [A Bit Rate]
- ☞ P116 [B Bit Rate]

- When [Main Menu] → [System] → [Record Set] → [Record Format] → [Format] is set to “AVCHD”

Resolution	1080p	1080i					480i/ 576i
		HQ	SP	LP	EP	-	
4GB	16	19	25	46	82	50	
8GB	33	39	50	95	168	103	
16GB	67	78	100	190	336	209	
32GB	135	156	200	380	672	420	
64GB (SDXC)	270	312	400	760	1344	842	
128GB (SDXC)	540	624	800	1520	2688	1687	

(Unit: minute)

- When [Main Menu] → [System] → [Record Set] → [Record Format] → [Format] is set to “QuickTime”

System	4K	HD		SD	Web	
Resolution	2160p	1080i/1080p		480i/ 576i	960p	480p
Bit Rate	-	XHQ	UHQ	-	HQ	LP
4GB	3	9	12	47	130	285
8GB	6	18	25	95	270	580
16GB	12	36	50	190	540	1160
32GB	25	72	100	380	1080	2320
64GB (SDXC)	50	145	200	760	2160	4720
128GB (SDXC)	100	290	400	1520	4320	9440

(Unit: minute)

Memo :

- If the SD card contains files recorded by devices other than this camera recorder or files that are saved from a PC, the recordable time may be shorter or data may not be properly recorded.
- For each file format, up to 600 clips can be recorded to one SD card on this camera recorder. When 600 clips are recorded to one card, the remaining space is displayed as 0 min regardless of the estimated recordable time, and no further recording can be performed.
- When the file format is set to “AVCHD”, up to 4000 clips can be recorded to one SD card.

Write-Protect Switch on the SD Card

- Slide the write-protect switch upward to enable writing or deleting.
- Slide the write-protect switch downward to prevent writing or deleting. (Images in the card are protected.)

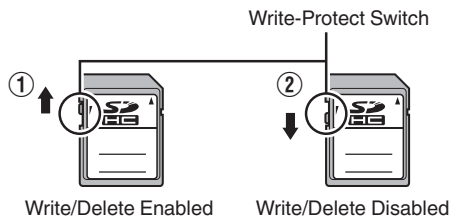

Inserting an SD Card

This camera recorder comes with two card slots (Slot A and B) for video/audio recording and playback.

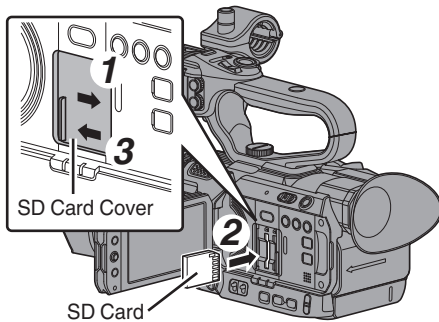

- 1 **Open the SD card cover by sliding the cover in the direction indicated by the arrow.**
- 2 **Insert an SD card with the notched corner pointing up.**
The status indicator of the card slot to which the card was inserted lights up in red.
- 3 **Close the SD card cover in the direction indicated by the arrow.**

Card Slot Status Indicator

The following table shows the respective states of slot A and B.

Lamp	Slot Status
Lights up in red	The inserted SD card is being accessed. (writing/reading data) Do not turn off the power of the camera recorder or remove the SD card.
Lights up in green	On standby. The inserted SD card can be used for recording or playback.
Light goes out	<ul style="list-style-type: none"> • SD card is not inserted. • An unusable card is inserted. • An SD card is inserted but a different slot is selected.

Removing the SD Card

- 1 **Check that the SD card to be removed is not being accessed (status indicator of the card slot lights up in red).**
- 2 **Slide open the SD card cover.**
- 3 **Push the SD card and remove it from the slot.**
- 4 **Close the SD card cover.**

Memo : _____

- When both slots are inserted with usable SD cards, the previously selected slot is used.

Caution : _____

- Data may be lost if you turn off the power of the camera recorder or remove the SD card when it is being accessed. All data recorded on the card, including the file that is being accessed, may be corrupted. Be sure to check whether the status indicator is lit in green or turned off before you turn off the power or remove the SD card.
- If you mistakenly remove the card when it is being accessed, reinsert the card only after the status indicator goes off.
- The SD card may not be recognized if you insert and remove the card within a short time. When this happens, remove the card and wait for a few seconds before you reinsert.

Switching the SD cards

When both card slots are inserted with SD cards, you can use the [SLOT SEL] button to switch the card to use.
When the memory on an SD card is full during recording, data recording automatically switches to the other card.

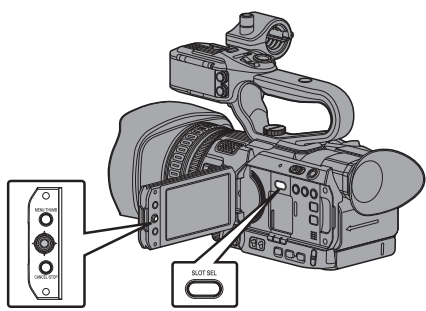

Memo : _____
• The [SLOT SEL] button is disabled during recording or playback. Cards will not be switched even if you press the button.

Formatting (Initializing) SD Cards

When the following cards are inserted, [FORMAT] appears at the remaining media display area. Format the card using the camera recorder menu.

- Unformatted SD cards
 - SD cards formatted under different specifications
- * For details of the menu operation, refer to "[Basic Operations in Menu Screen] (P 92)".

Caution : _____
• Be sure to format the SD card on this camera recorder. SD cards formatted on a PC and other peripheral equipment cannot be used on this camera recorder.
• [RESTORE] appears at the remaining media display area when an SD card that requires restoring is inserted.

- 1 Select [System] → [Media] → [Format Media].
(P113 [Format Media])
- 2 Select the slot of the SD card to be formatted and press the Set button (●).

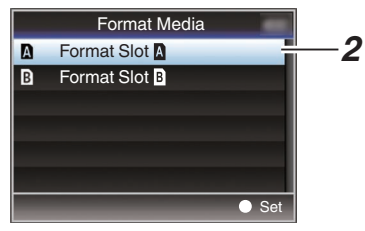

- 3 The status of the selected SD card appears.
- 4 Select [Format] and press the Set button (●).

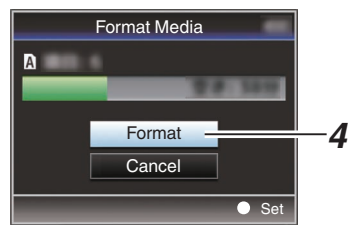

- 5 Formatting starts.

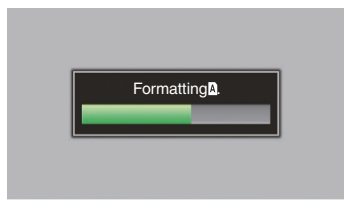

6 Formatting is complete.

When formatting is complete, “Complete” appears and the camera recorder returns to the [Format Media] screen.

Memo : _____

- During formatting, menu operation is unavailable but you can start recording. However, this is only available when a recordable SD card is inserted in the other slot.
- Formatting cannot be performed in the following cases.
 - Recording is in progress on the SD card to be formatted.
 - SD card is not inserted.
 - Write-protect switch of the SD card is set (🔒 is displayed).

Caution : _____

- If you format the SD card, all data recorded on the card, including video data and setup files, will be deleted.

Restoring the SD Card

It is necessary to restore the SD card if an abnormality occurs to the data in the card due to some reasons.

Memo : _____

- [!RESTORE] appears at the remaining media display area when an SD card that requires restoring is inserted.

1 Select [System] → [Media] → [Restore Media].

(☞ P113 [Restore Media])

2 Select the SD card to be restored and press the Set button (●).

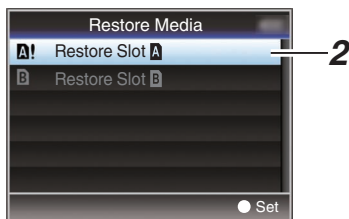

3 Restoring starts.

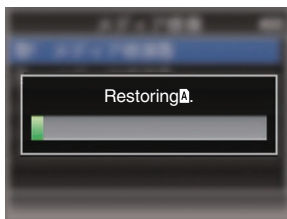

4 Restoring is complete.

- When restoring is complete, “Complete” appears and the camera recorder returns to the [Restore Media] screen.
- When no media that requires restoring is inserted, the camera recorder returns to the [Media] menu screen.

Caution : _____

- [Restore Media] can only be selected in Camera mode. However, it cannot be selected while the camera recorder is recording. Select [Restore Media] in Camera mode when the camera recorder is not recording.
- [Restore Media] does not restore the SD card to its original states completely. If restoring fails, replace or format the SD card. Take note that formatting erases all the information inside the SD card.
- Restoring cannot be performed in the following cases.
 - Camera recorder is recording in progress.
 - SD card is not inserted.
 - Write-protect switch of the SD card is set (🔒 is displayed).

Clips Recorded to SD Cards

Folders in the SD Card

The captured image is recorded into different folders according to the [System] and [AFormat]/[BFormat] settings.

System	AFormat/ BFormat	Record Folder
4K/HD/SD/ Web	QuickTime	DCIM
HD/SD/ Web	AVCHD	PRIVATE/AVCHD

Memo : _____

- By formatting (initializing) the SD card from the [Format Media] menu on the camera recorder, folders required for recording in the current [System] settings will be generated.
- When the [System] settings and [QuickTime] settings are changed, folders required for recording in those settings will be automatically generated.

Caution : _____

- When a clip inside the folder is moved or deleted using the Explorer (Windows) or Finder (Mac), recording to the SD card may fail if formatting (initializing) of the card is not performed.

Clip (Recorded Data) and Clip Name

- When recording is stopped, the images, audio and accompanying data which are recorded from start to stop are recorded as one "clip" on the SD card.
- An 8-character clip name is automatically generated for the recorded clip. ("Clip Name Prefix" + "Clip Number")
- When [Main Menu] → [System] → [Record Set] → [Record Format] → [AFormat] is set to "AVCHD", the clip name generated consists of only the Clip Number (5-digit number). (P115 [A Format])

Example: QuickTime

ABCG0001

Clip Number

A number in automatic ascending order is assigned in the recording order.

The Clip Number can be reset in the menu.*

Clip Name Prefix (any four alphanumeric characters)

This is set to "xxxG" ("xxx" denotes the last 3 digits of the serial number) by default.

- * [Clip Set] → [Reset Clip Number]
(P118 [Reset Clip Number])

Memo : _____

- Before recording starts, you can set any characters for the clip name prefix by using [Main Menu] → [System] → [Record Set] → [Clip Set] → [Clip Name Prefix].
(P118 [Clip Name Prefix])
- Changes cannot be made after recording.

Recorded Clips

- The recorded materials may be split into several files but they can be played back continuously on the camera recorder.
- Clips may be recorded across the two SD cards in card slots A and B depending on the recording time of the clip.

Caution : _____

- A clip recorded across several cards cannot be played back continuously. Continuous playback is only possible when the recording is made on one card.

Operation Lock Feature

You can use this feature to prevent erroneous camera operation.

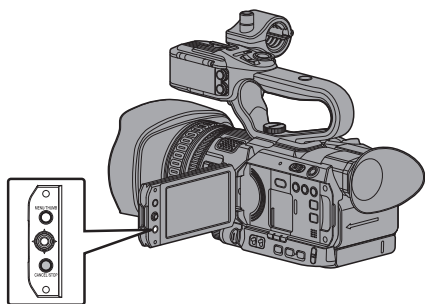

1 While in the Camera mode (when the display screen appears), press and hold the [CANCEL] button for 5 seconds or longer.

- The operation lock turns on, and an operation lock icon (🔒) appears on the display screen.

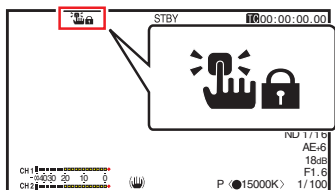

- Press the [CANCEL] button again for 5 seconds or longer to turn off the operation lock.

Memo : _____

- The operation lock feature is only valid in the Camera mode.
(P18 [Operation Modes])
- The power turns off and the operation lock is disengaged.
- The following remote operations are possible even when the operation lock feature is turned on ("On").
 - Remote operation from the wired remote control connected to the [REMOTE] terminal.
 - Remote operation of the camera through access via a browser on devices such as a smartphone, tablet terminal, or PC.

Operation lock does not apply to the following buttons and switches.

- [POWER ON/OFF] switch
- [INPUT1]/[INPUT2] Audio input signal selection switch **HDL**
- [CH1]/[CH2] Audio input signal selection switch **HDL**
- [CH1 AUTO/MANUAL]/[CH2 AUTO/MANUAL] Audio recording mode switch **HDL**
- Focus ring
- Zoom lever at the grip/Zoom lever at the handle **HDL**/Zoom ring at the lens section
- [ZOOM L/M/H] Zoom Speed Switch **HDL**
- Iris Dial
- [REC/HOLD] Record Trigger Button/Lock Switch **HDL**
- [REC] button (on the grip)
- Visibility Adjustment Lever
- User button that has been assigned with the [Rec] function.

Basic Shooting Procedures

Preparations

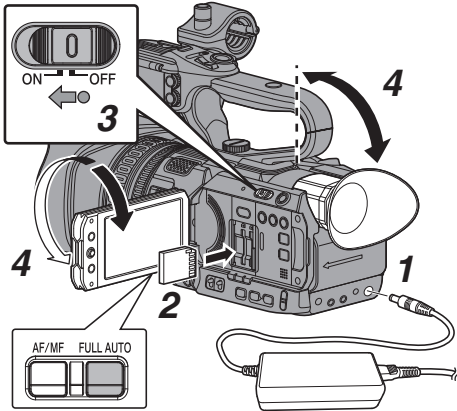

- 1 **Supply battery or AC adapter power to the camera recorder.**
(☞ P29 [Power Supply])
- 2 **Insert an SD card.**
(☞ P40 [SD Card])
- 3 **Turn on the power of the camera recorder.**
Hold down the lock button (blue) at the center of the [POWER ON/OFF] switch to set to “ON”. The camera recorder starts up in Camera mode and is ready for recording.
- 4 **Adjust the angle of the LCD monitor and viewfinder.**
(☞ P37 [Adjusting the LCD Monitor and Viewfinder])

Shooting

The [FULL AUTO] button of this camera recorder is set to “ON” by default, the following video items are automatically adjusted.

- Iris
- Gain
- Shutter
- White balance

The audio recording level is also automatically configured, and audio from the built-in microphone is recorded.

When the [FULL AUTO] button is set to “ON”, the **A** icon appears at the lower center area of the LCD.

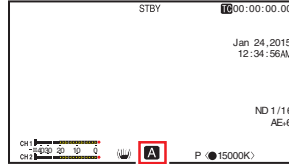

- * Press and hold the [FULL AUTO] button to switch the Full Auto mode ON and OFF.

Memo : _____

- To set each individual video setting item automatically or manually, and to carry out the audio input settings and the audio recording level adjustment, refer to the following.
 - [Adjusting the Brightness] (☞ P 54)
 - [Adjusting the Iris] (☞ P 55)
 - [Setting the Gain] (☞ P 57)
 - [Setting the Electronic Shutter] (☞ P 58)
 - [Adjusting the White Balance] (☞ P 60)
 - [Selecting Audio to Be Recorded in Each Channel **HDL**] (☞ P 65)
 - [Adjusting the Audio Recording Level **HDL**] (☞ P 66)

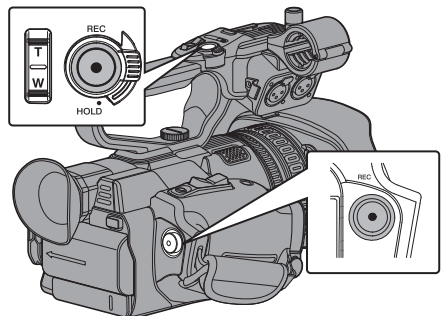

1 Press the [REC] button to start recording to the SD card.

- This camera recorder has two [REC] buttons. Any of the [REC] buttons can be used to start/stop recording by default. The tally lamp lights up in red during recording.
- Zoom Operation (P49 [Zoom Operation])
 - Adjusting the Focus (P50 [Focus Operation])

Memo : _____

- If both the slots are loaded with recordable cards in the factory default, pressing the [REC] button starts recording only to the media in the selected slot. When [Main Menu] → [System] → [Record Set] → [Slot Mode] is set to “Dual”, recording can be performed simultaneously to the cards in both the slots. (P74 [Dual Rec])
- The tally lamp can be turned off in [System] → [Tally Lamp]. (P113 [Tally Lamp])

2 Check the most recently captured images.

- Press the [C.REVIEW/4] button to activate the Clip Review function. The most recently captured images are played back on the LCD monitor and viewfinder screen.
- After playback, the camera recorder returns to standby mode (STBY). (P73 [Viewing Recorded Videos Immediately (Clip Review)])

Memo : _____

- [Clip Review] is assigned to the [C.REVIEW/4] button in factory default.
- [Clip Review] can also be assigned to other user buttons. (P39 [Assignment of Functions to User Buttons])

Selecting System Definition, File Format and Video Format

You can select the resolution of the recorded videos (4K, HD, SD, or Web), file format for recording/playback, and the video recording format on this camera recorder.

Setting the Record Format Menu

- 1 Set [System], [Format], [Resolution], [Frame Rate] and [Bit Rate] in [Main Menu] → [System] → [Record Set] → [Record Format].
- 2 Set each of the items.
 - ① [Selecting a System Definition] (P 47)
 - ② [Selecting a File Format] (P 48)
 - ③ [Selecting a Video Format] (P 48)
 - ④ [Selecting the Aspect Ratio of SD Videos] (P 49)
- 3 After setting is complete for all items, press the [LOLUX/3] button.
 - The recording format is switched.
 - A “Please Wait...” message appears on the screen during switching.

Selecting a System Definition

There are four different definitions for selection.

- 4K: Records in 4K resolution (3840x2160)
- HD: Records in HD (High Definition) resolution (1920x1080 or 1280x720)
- SD: Records in SD (Standard Definition) resolution (720x480 or 720x576)
- Web: Records in resolution (1440x1080, 960x480, 720x480, 720x576, or 480x270) suitable for web distribution

You can select a definition for the recorded images from the following items under [System].

- 4K: Records in 4K quality for both slots A and B.
- HD: Records in HD quality for both slots A and B.
- SD: Records in SD quality for both slots A and B.
- HD+Web: Records in HD quality for slot A, and Web quality for slot B. (P74 [Recording Simultaneously at Two Different Definitions])

Selecting a File Format

Select a file format in [A Format]/[B Format].
There are two file formats for selection.

- AVCHD:
AVCHD file format
- QuickTime:
QuickTime file format (.MOV)

Memo : _____

- When [System] is set to “4K”, this item is fixed at “QuickTime”.

Selecting a Video Format

- Select a [Record Format] from the list of formats. The selectable [A Frame Rate]/[A Bit Rate]/[B Frame Rate] and [B Bit Rate] change according to the settings of [System]/[A Format]/[A Resolution]/[B Format], and [B Resolution].

List of Formats

The following is a list of file formats and video formats that can be selected on this camera recorder.

- When [System] is set to “4K”

Record Format			
A Format	A Resolution	A Frame Rate	A Bit Rate
Quick Time	3840x2160	30p 25p 24p	150M

Memo : _____

- Each item for slot B is fixed at the same setting as slot A.

- When [System] is set to “HD” or “HD+Web”, the options for slot A are:

Record Format			
A Format	A Resolution	A Frame Rate	A Bit Rate
QuickTime	1920x1080	60p 60i 50p 50i 30p 25p 24p	50M (YUV422) 50M (XHQ) 35M (UHQ)
		1280x720	60p 50p
AVCHD	1920x1080	60p	28M (HQ)
		60i	24M (HQ) 18M (SP)
		50p	28M (HQ)
		50i	24M (HQ) 18M (SP)

Memo : _____

- When [A Format] is set to “Quick Time” and [A Resolution] is set to “1920x1080”, the selectable options for [A Bit Rate] vary according to the setting for [A Frame Rate].
- When [System] is set to “HD”, each item for slot B is fixed at the same setting as slot A.
- When [System] is set to “HD+Web”, “50M(YUV422)” cannot be selected.

- When [System] is set to “SD”

Record Format			
A Format	A Resolution	A Frame Rate	A Bit Rate
QuickTime	720 x 480	60i (U model)	8M
	720 x 576	50i (E model)	
AVCHD	720 x 480	60i (U model)	
	720 x 576	50i (E model)	

Memo : _____

- Each item for slot B is fixed at the same setting as slot A.

- When [System] is set to “HD+Web”, the options for slot B are:

Record Format			
B Format	B Resolution	B Frame Rate	B Bit Rate
QuickTime	960 x 540	30p 25p 24p	3M (HQ)
	720 x 480	60i	8M
	720 x 576	50i	
	480x270	30p 25p 24p	1.2M (LP)
AVCHD	1440 x 1080	60i 50i	9M (LP) 5M (EP)
	720 x 480	60i	8M
	720 x 576	50i	

Memo : _____

- The available options for [B Resolution] and [B Frame Rate] vary according to the settings for slot A.
- The selectable options for [B Resolution] vary according to the [A Frame Rate] setting.
- [B Frame Rate] is fixed according to the [A Frame Rate] setting.

Selecting the Aspect Ratio of SD Videos

For setting the aspect ratio of the SD recording image when [System] is set to “SD”. You can select “16:9” or “4:3”.

Memo : _____

- For conditions other than those above, this item is fixed at “16:9”.

Zoom Operation

Adjusts the angle of view.

Optical zoom ratio: 1x to 12x

Dynamic zoom ratio: 12x to 24x

Set the dynamic zoom “On”/“Off” in [Main Menu] → [Camera Function] → [Dynamic Zoom].

(☞ P97 [Dynamic Zoom])

Zooming can be operated using any of the three levers/rings below.

- Zoom Lever at the Grip
- Zoom lever at the Handle **HDL**
- Zoom Ring at the Lens Section

During the zoom operation, the zoom bar or number will appear on the upper right corner of the screen.

(☞ P130 [Zoom Display])

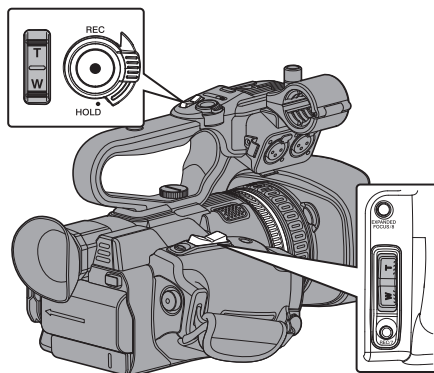

Using the Zoom Lever at the Grip

- 1 Press the zoom lever to zoom.
 - The zoom speed changes according to the extent the zoom lever is being pushed.
 - Zooms into wide angle and increases the angle of view when “W” is pressed.
 - Zooms into telephoto and decreases the angle of view when “T” is pressed.

Using the Zoom Lever at the Handle **HDL**

- 1 Set the zoom speed individually in [Main Menu] → [Camera Function] → [Handle Zoom Speed L]/[Handle Zoom Speed M]/[Handle Zoom Speed H].

- Set the zoom speed for “L”, “M” and “H” of the [ZOOM L/M/H] zoom speed switch individually.
Increasing the value increases the zoom speed.
- (☞ P97 [Handle Zoom Speed L/Handle Zoom Speed M/Handle Zoom Speed H **HDL**])

Memo : _____

- The zoom lever on the handle is disabled when “Off” is selected.
-
- 2 **Set the [ZOOM L/M/H] zoom speed switch to any of the settings.**
 - 3 **Press the zoom lever at the handle to zoom.**
 - The zoom operation is performed in the speed that has been set.

Using Zoom Ring at the Lens Section

You can adjust the preferred angle of view by turning the zoom ring.

Saving/Recalling Current Zoom Position (Preset Zoom)

This allows you to register up to three zoom positions.

- 1 **Assign the “Preset Zoom1”, “Preset Zoom2”, or “Preset Zoom3” function to any of the user buttons.**
(☞ P39 [Assignment of Functions to User Buttons])
(☞ P98 [USER1 ~ USER9, LCD KEY▲/LCD KEY▶/LCD KEY▼/LCD KEY◀])
- 2 **Save the current zoom position.**
 - Press any of the user buttons assigned with the “Preset Zoom1”, “Preset Zoom2”, or “Preset Zoom3” function for more than 1 second.
 - The current zoom position will be stored.
- 3 **Recall the stored zoom position.**
 - Press any of the user buttons assigned with the “Preset Zoom1”, “Preset Zoom2”, or “Preset Zoom3” function and release within 1 second.
 - The camera recorder zooms to the stored zoom position.

Memo : _____

- The zoom speed to the zoom position can be set in [Main Menu] ➔ [Camera Function] ➔ [User Switch Set] ➔ [Preset Zoom Speed].
(☞ P99 [Preset Zoom Speed])
- Operating other zoom maneuvers during a zoom position recall will cancel the recall.

Focus Operation

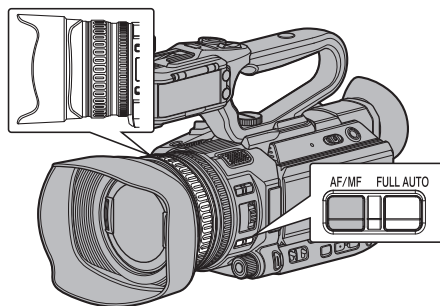

Adjusting Focus Automatically

- 1 **Press the [AF/MF] selection button to set to Auto Focus mode.**

There is no icon display in Auto Focus mode.

Memo : _____

- If [Main Menu] ➔ [Camera Function] ➔ [AF Assist] is set to “Area” or “Far/Near”, you can turn the focus ring to shift the auto focus point while in the automatic focus adjustment mode.
(☞ P97 [AF Assist])
- When face detection is enabled, the Auto Focus icon  appears with the face mark.
(☞ P53 [Adjusting the Focusing by Face Detection])
(☞ P98 [Face Detect])

One Push Auto Focus

If [Push AF/AF Lock] is assigned to the user button, pressing the assigned user button (within 1 minute) while in the Manual Focus mode makes the camera recorder focus on the center of the frame automatically.

Memo : _____

- Face detection does not work during One Push Auto Focus.
- AF Assist does not function.
- When the operation is complete, the camera recorder returns to the Manual Focus mode automatically.
- One Push Auto Focus functions with emphasis on the focusing speed. This function is not suitable during recording.

Setting to Auto Focus Temporarily (Push Auto Focus)

- If [Push AF/AF Lock] is assigned to the user button, the camera recorder will shift to Auto Focus mode temporarily and automatically adjusts focus when the assigned user button is held down during shooting in Manual Focus mode.
- Release the user button assigned with [Push AF/AF Lock] to return to Manual Focus mode.

Memo : _____

- Face detection does not work during Push Auto Focus.

Locking the Focus

When the [Push AF/AF Lock] function is assigned to a user button in the Auto Focus mode, pressing this button locks the focus on the corresponding point.

An **AF** icon appears when the focus is locked.

Memo : _____

- Performing any focusing operation when the focus is locked disengages the focus lock.

Adjusting Focus Manually

- 1 Press the [AF/MF] selection button to set to **Manual Focus mode**.
The manual focus icon **MF** appears on the screen.

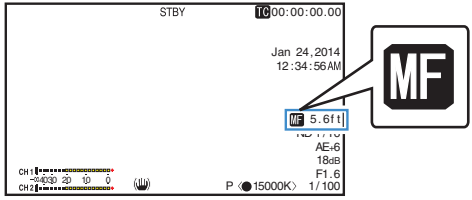

Memo : _____

- The **MF** icon appears even when [Main Menu] → [LCD/VF] → [Display Settings] → [Focus] is set to "Off".
(P107 [Focus])

- 2 Turn the focus ring to adjust the focus.

Memo : _____



- Using the Focus Assist or Expanded Focus function makes it easier to focus.
(P52 [Focus Assist Function])
(P52 [Expanded Focus Function])
- If [Push AF/AF Lock] is assigned to the user button, pressing the assigned user button while in the Manual Focus mode activates the One-push Auto Focus mode, and holding down the button activates the Push Auto Focus mode.
(P50 [One Push Auto Focus])
(P51 [Setting to Auto Focus Temporarily (Push Auto Focus)])

AF Assist Function

To shift the auto focus point during Auto Focus (AF), you can turn the focus ring to set the point to the left, center, right, or near and far directions.

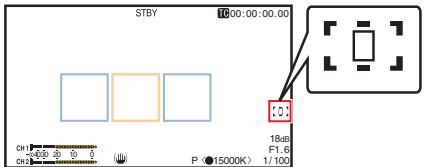
- Set [Main Menu] → [Camera Function] → [AF Assist].
 - Far/Near:
This option allows you to shift the auto focus point to near and far directions by turning the focus ring during AF.
Focus is automatically adjusted to a focus point near the position where the focus ring stops turning.
 - Area:
Selecting this option displays the  icon in the area.
Turning the focus ring during AF displays the focus area on the left, center, and right side for about 2 seconds. Turning the focus ring within 2 seconds allows you to move the orange frame to select the focus area.
After selecting the area, focus is automatically adjusted to a focus point near the selected area.



- * The icons (, , and ) change in conjunction with the orange frame in the focus area.

Memo : _____

- When [Face Detect] is set, the AF Assist function is not selectable.

Focus Assist Function

- When the [F.ASSIST/1] button is pressed during shooting, the focused area is displayed in color. This enables easy and accurate focusing.
- Select the color (blue, red or green) in the menu.

Memo : _____

- When [Main Menu] → [LCD/VF] → [Shooting Assist] → [Focus Assist] → [Type] is set to “ACCU-Focus”, the depth of field becomes shallower to enable easier focusing.
(☞ P105 [Focus Assist])
- The “ACCU-Focus” function switches automatically to “Off” after about 10 seconds.
- Select the display color in [Main Menu] → [LCD/VF] → [Shooting Assist] → [Focus Assist] → [Color].
(☞ P105 [Color])
- If you use the zebra function and the Focus Assist function at the same time, it may be difficult to see the effect of the Focus Assist. In this case, turn off the zebra function.

Setting Focus Assist Function to a User Button

You can assign the “Focus Assist” function to a user button.

(☞ P39 [Assignment of Functions to User Buttons])

Expanded Focus Function

You can magnify the preferred area by pressing the [EXPANDED FOCUS/8] button; doing so enables precise focus to be established easily.

- * You can also use the user button assigned with the “Expanded Focus” function instead of the [EXPANDED FOCUS/8] button.

(☞ P39 [Assignment of Functions to User Buttons])

(☞ P98 [USER1 ~ USER9, LCD KEY▲/LCD KEY▶/LCD KEY▼/LCD KEY◀])

1 Press the [EXPANDED FOCUS/8] button.

- “EXPANDED” (yellow color) appears on the screen, and the center part of the image is enlarged if this button is pressed for the first time.
- For subsequent operation of the button, the area at which the operation was last performed will be enlarged.

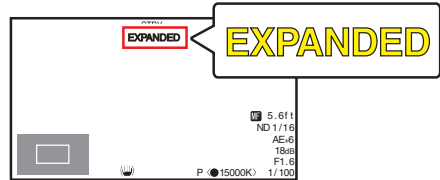

2 Use the cross-shaped button (▲▼◀▶) to magnify the preferred area.

- The portion that is being magnified is displayed at the lower left corner of the screen.

3 Press the [CANCEL/STOP] button to cancel the setting.

Memo : _____

- The display of the enlarged screen is dot by dot equivalent.
- To set the operation when the button is pressed, go to [Main Menu] → [Camera Function] → [User Switch Set] → [Expanded Focus].
(☞ P99 [Expanded Focus])
- Pressing and holding the Center Set button (●) resets the position of magnification.
- This function can be used together with the Focus Assist function.
- When [Main Menu] → [Camera Function] → [AF Assist] is set to “Area”, the center of each area (left/center/right) is enlarged.
(☞ P97 [AF Assist])
- The magnification ratio varies with the format of the record signals.
- Magnifying an image does not alter the size of the recorded image.
- If the “Expanded Focus” function is assigned to the cross-shaped button, the cross-shaped button cannot be used as user button while the area is being magnified.
- This function is unavailable when [Main Menu] → [System] → [Record Set] → [Record Format] → [System] is set to “SD”.

Adjusting the Focusing by Face Detection

This function detects human faces and automatically adjusts focus during Auto Focus. It can also track moving objects. When several faces are detected, you can select one to focus on.

Memo : _____

- This function can also adjust the brightness automatically according to the brightness of the face detected.

(☞ P98 [Face Detect])

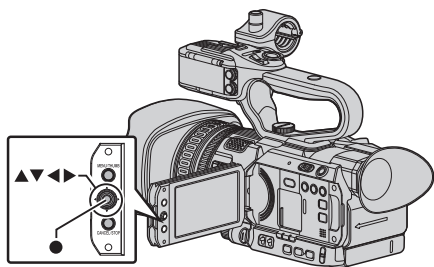

1 Assign the “Face Detect” function to any of the user buttons.

(☞ P39 [Assignment of Functions to User Buttons])

2 Focus the camera recorder on a person and press the user button that is assigned with “Face Detect”.

- When Face detection is enabled, the face detection icon (AF) appears.
 - When [Main Menu] → [Camera Function] → [User Switch Set] → [Face Detect] is set to “AF”, “AF” appears.
 - When [Main Menu] → [Camera Function] → [User Switch Set] → [Face Detect] is set to “AF&AE”, “AE±0” appears.
- If you select the person nearest to the center of the screen, an orange frame will appear on his face.
- Focus will be automatically adjusted for the selected person.

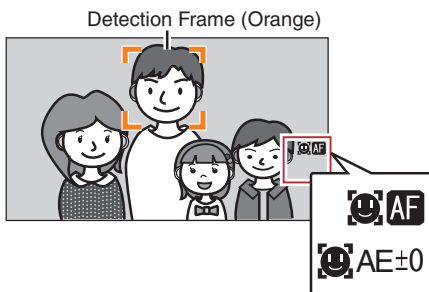

Memo : _____

- If the detection frame does not appear, make sure that Auto Focus mode is selected. Also, if [Face Detect] is set to “AF&AE”, set at least one of the iris, gain, and electronic shutter control items to the automatic adjustment mode.
(☞ P54 [Adjusting the Brightness Automatically: Automatic Brightness Adjustment (AE) Mode])
(☞ P55 [Auto Iris (Automatic Adjustment) Mode])
(☞ P57 [Automatic Gain Mode (Automatic Gain Adjustment)])
(☞ P58 [Automatic Shutter Mode (Automatic Shutter Adjustment)])

Selecting Specific Person from Several Persons

- Hold down the user button that is assigned with "Face Detect".**
 - The camera recorder will enter face selection mode and the face detection icon (👤) will blink.
 - An orange frame will appear on the face of the person nearest to the center of the screen. Blue frames will appear on the faces of others.

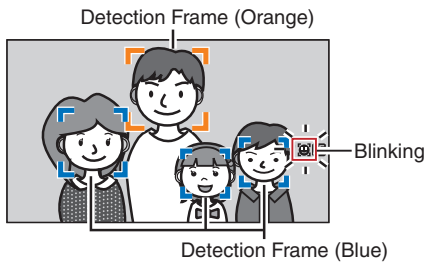

- Select a specific person.**
 - Use the cross-shaped button (◀▶▲▼) to select a person.
 - An orange frame will appear on the face of the selected person and focus will be automatically adjusted.

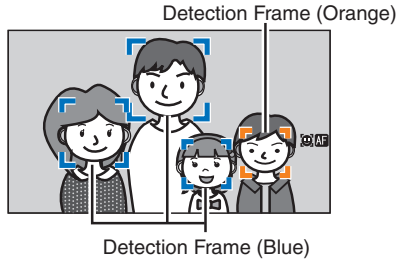

- Press the Set button (●) to confirm the person for face detection.**

Memo : _____

- Press the [CANCEL] button to cancel the selection.
- You can specify the detection sensitivity and the operation speed after losing sight of the face using [Main Menu] ➔ [Camera Function] ➔ [User Switch Set] ➔ [Face Detect] ➔ [Sensitivity] and [Hysteresis].
 (☞ P98 [Sensitivity])
 (☞ P98 [Hysteresis])

Adjusting the Brightness

Adjust the brightness using Iris, Gain, Shutter speed and ND filter according to the brightness of the object.

Adjusting the Brightness Automatically: Automatic Brightness Adjustment (AE) Mode

Iris, Gain, Shutter speed and ND filter are automatically adjusted according to the brightness of the object to maintain optimum brightness.

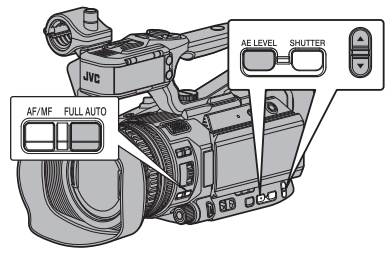

To set only the Gain, Iris and Shutter to Auto mode, press and hold the [FULL AUTO] button and set the Full Auto mode to off before setting each item to the automatic adjustment mode.

- Set Gain, Iris and Shutter to Auto mode.**
 - [Adjusting the Iris] (☞ P 55)
 - [Setting the Gain] (☞ P 57)
 - [Setting the Electronic Shutter] (☞ P 58)
- Set the target level (brighter/darker) to maintain optimum brightness during automatic adjustment.**
 - When "AE±*" (* denotes number) appears on the screen, press the [AE LEVEL] button on the side of the camera recorder to display "AE ±*" against a white background and set using the ▲ / ▼ volume buttons.

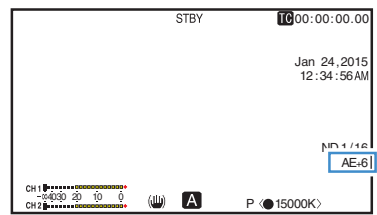

Memo : _____

- Pressing and holding the [FULL AUTO] button to enter the Full Auto mode also activates the automatic brightness adjustment (AE) mode. In this case, the White Balance also enters into Auto mode forcibly.
- Pressing and holding the [AE LEVEL] button clears the value specified and fixes at “AE±0” (recommended value).
- The convergence speed of the automatic adjustment for automatic brightness adjustment (AE) can be set in the menu.
(☞ P96 [AE Speed])
- If one or more of the items (Gain, Iris and Shutter) have been set to Auto mode, the value of the corresponding items when the user button that is assigned “AE Lock” is pressed can be fixed.
(☞ P99 [AE/FAW Lock])
- If one or more of the items (Gain, Iris and Shutter) have been set to Auto mode, the automatic brightness adjustment (AE) mode is enabled.

Adjusting the Brightness Manually

Press and hold the [FULL AUTO] button to set to Full Auto mode, some or all of the items (Iris, Gain and Shutter Speed) can be manually adjusted.

- 1 Press and hold the [FULL AUTO] button to set Full Auto mode to off.
- 2 Adjust the Iris, Gain and Shutter speed.
(☞ P55 [Adjusting the Iris])
(☞ P57 [Setting the Gain])
(☞ P58 [Setting the Electronic Shutter])

Memo : _____

- The brightness cannot be manually adjusted in the Full Auto mode.
- If Iris, Gain and Shutter Speed are manually adjusted, the [AE Level] setting is temporarily disabled.

Adjusting the Iris

Adjust the aperture of the lens iris according to the brightness of the subject.

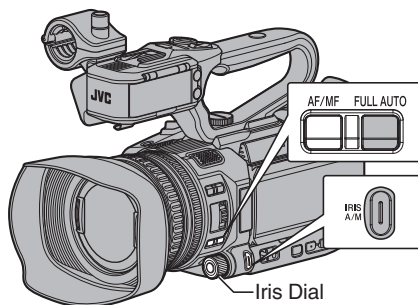

Auto Iris (Automatic Adjustment) Mode

- 1 Press and hold the [FULL AUTO] button to set Full Auto mode to off.
- 2 Press the [IRIS A/M] button to set to the Auto Iris mode.
The iris is automatically adjusted according to the brightness of the object.
The lens aperture value (F-number) is not displayed in the Auto Iris mode.

Memo : _____

- Pressing and holding the [FULL AUTO] button to enter the Full Auto mode also activates the Auto Iris mode. In this case, the Gain, Shutter and White Balance also enter into Auto mode forcibly.
The switching operation of the [IRIS A/M] button is disabled in the Full Auto mode.
- The iris open/close limit can be set in [Main Menu] → [Camera Function] → [Auto Iris Limit (OPEN)]/[Auto Iris Limit (CLOSE)] during Auto Iris.
(☞ P96 [Auto Iris Limit (OPEN)])
(☞ P96 [Auto Iris Limit (CLOSE)])
- To set the target level (brighter/darker) of the auto iris, you can press and hold the [AE LEVEL] button on the side of the camera recorder and then change the level using the ▲ / ▼ volume button.
- The convergence speed of the auto iris can be set in the menu.
(☞ P96 [AE Speed])

Manual Iris (Manual Adjustment) Mode

The aperture value (F-number) of the lens can be set manually.

- 1 Press and hold the [FULL AUTO] button to set Full Auto mode to off.
- 2 Press the [IRIS A/M] button to set to the Manual Iris mode.
The lens aperture value (F-number) is displayed.

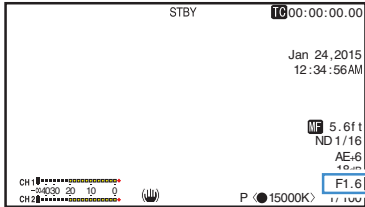

- 3 Turn the iris dial to adjust the iris manually.
 - Iris adjustment can be assigned to the zoom ring.
Set [Main Menu] → [Camera Function] → [Zoom Ring] to "Iris".
(P97 [Zoom Ring])

The open F-number of the aperture varies according to the zoom position.

Wide [W] end : F1.2
Tele [T] end : F3.5

F-number	Description
Decrease	The subject appears brighter. The focused range becomes sharper, while the background is blurred to produce a soft image.
Increase	The subject appears darker. Background of image becomes focused as well.

Memo : _____

- If [One Push Iris] is assigned to the user button, pressing the assigned user button while in the Manual Iris mode activates the One-push Auto Iris mode, and holding down the button activates the Push Auto Iris mode.
- In addition to the [Iris] function, the iris dial can also be assigned with the [Shutter] or [AE Level] function.
(P97 [Iris Dial])

One Push Auto Iris

When [One Push Iris] is assigned to the user button, press this button in the Manual Iris mode to adjust the iris according to the brightness of the subject.

Push Auto Iris

When [One Push Iris] is assigned to the user button, press and hold down this button in the Manual Iris mode to change to the Auto Iris mode temporarily. The iris will be automatically adjusted according to the brightness of the subject.

About the Iris F-number

Blurry effects due to "small aperture diffraction" may occur when the diameter of the iris becomes too small. When this phenomenon occurs, the F-number on the screen turns gray to warn you that the diffraction F-number of the iris has been exceeded.

You are recommended to make appropriate use of ND filters to prevent the F-number from turning gray.

Setting the Gain

This function electrically boosts the light sensitivity when there is insufficient illumination on the object. You can set the gain of the video amplifier according to the brightness of the object. Select the setting mode according to your shooting conditions.

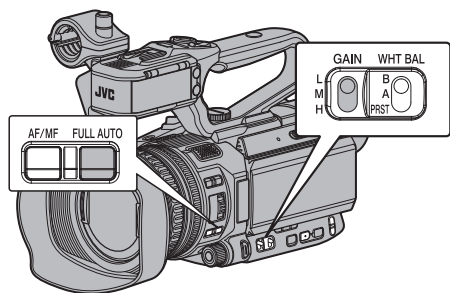

Automatic Gain Mode (Automatic Gain Adjustment)

1 Press and hold the [FULL AUTO] button to set Full Auto mode to off.

2 Set [Camera Function] → [GAIN L]/[GAIN M]/[GAIN H] to “AGC”.

(☞ P97 [GAIN L/GAIN M/GAIN H])

If an item specified with “AGC” is selected using the [GAIN L/M/H] gain switch, the Auto Gain Adjustment mode is enabled and the gain of the video amplifier is automatically set according to the brightness of the subject.

The sensitivity value (dB value) is not displayed in the Auto Gain mode.

Memo : _____

- Pressing and holding the [FULL AUTO] button to enter the Full Auto mode also activates the Auto Gain mode. In this case, the Iris, Shutter and White Balance also enter into Auto mode forcibly.
- The switching operation of the [GAIN L/M/H] switch is disabled in the Full Auto mode.
- The upper limit of the gain setting value during AGC operation can be set in [Main Menu] → [Camera Function] → [AGC Limit].
(☞ P96 [AGC Limit])

Manual Gain Mode (Manual Gain Switching)

1 Press and hold the [FULL AUTO] button to set Full Auto mode to off.

- Select the gain level of the video amplifier using the [GAIN L/M/H] selection switch on the camera recorder.
- The gain level appears on the screen.

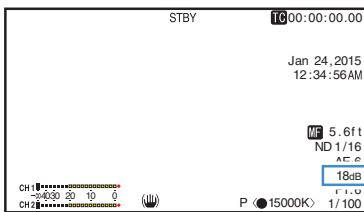

- The default positions of the switch are as follows.

[L] : 0dB

[M] : 6dB

[H] : 12dB

2 Select [GAIN L/M/H] that is not set to “AGC” to switch to the Manual Gain mode.

Memo : _____

- You can change the gain value of each position in the menu. Increasing the sensitivity causes the screen to appear grainier.
- The camera recorder switches to the Auto Gain mode when the gain value is set to “AGC”.
(☞ P97 [GAIN L/GAIN M/GAIN H])

Setting the Electronic Shutter

You can change the shutter speed (time for each shooting frame) using the electronic shutter function. Electronic shutter can be adjusted manually or automatically.

Automatic Shutter Mode (Automatic Shutter Adjustment)

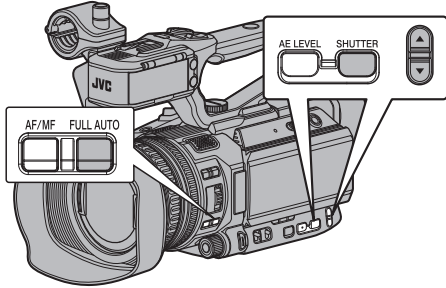

- 1 Press and hold the [FULL AUTO] button to set Full Auto mode to off.
- 2 Press and hold the [SHUTTER] button to enter Automatic Shutter mode.
 - The shutter speed will not be displayed.
 - Automatic Shutter mode adjusts the shutter speed automatically according to the brightness of the object.
- 3 Set the controllable range for the Automatic Shutter in [Main Menu] → [Camera Function] → [EEI Limit].
(☞ P96 [EEI Limit])

Memo : _____

- Pressing and holding the [FULL AUTO] button to enter the Full Auto mode also activates the Automatic Shutter mode. In this case, the Iris, Gain and White Balance also enter into Auto mode forcibly.
- Switching of shutter speed with the ▲/▼ volume buttons at the side of the camera recorder, and switching of shutter mode with the [SHUTTER] button are disabled in the Full Auto mode.

Manual Shutter Mode (Manual Shutter Switching)

- 1 Press and hold the [FULL AUTO] button to set Full Auto mode to off.
- 2 Press and hold the [SHUTTER] button to enter Manual Shutter mode.
 - The shutter speed appears on the screen.

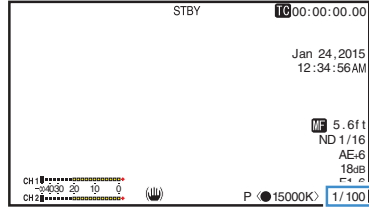

Memo : _____

- While in Manual Shutter mode, select “Step” or “Variable” in [Camera Function] → [Shutter]. “Step” is the factory default.
(☞ P96 [Shutter])

Switching Shutter Speed

When the [SHUTTER] button is pressed (for less than 1 second) in the Manual Shutter mode to display the shutter speed against a white background, you can set the shutter speed using the ▲/▼ volume buttons on the side of the camera recorder. The settable shutter speed range differs according to the video format setting.

Memo : _____

- To display Shutter in angle (DEG), set [A]Frame Rate] to “24p” or “25p”, and set [Shutter] in [LCD/VF] → [Display Settings] to “DEG”.
(☞ P115 [A Frame Rate])
(☞ P108 [Shutter])

Setting the ND Filter

Use the ND filter to keep the lens aperture in the appropriate range.

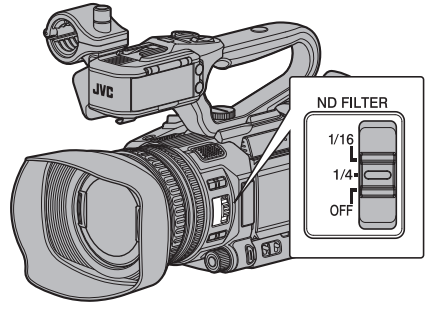

Switch according to the brightness of the object. When the position on the switch is changed, the selected position of the ND filter is displayed on the LCD monitor and viewfinder screen.
 (P127 [Display 2 screen])

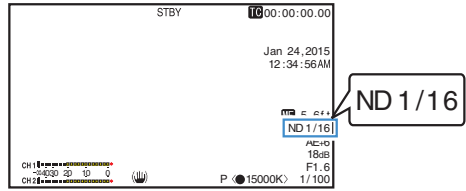

- Memo :
- When [Main Menu] → [LCD/VF] → [Display Settings] → [ND Filter] is set to “Off”, the position of the ND filter will not be displayed.
 (P107 [ND Filter])
 - It is recommended to use the ND filter to set the lens aperture to less than F8.

Shutter Mode		Frame Rate			
		60p 60i 30p	50p 50i 25p	24p	
▲	Step	—	—	1/10000	
				1/4000	
		1/10000	1/10000	1/2000	
		1/4000	1/4000	1/1000	
		1/2000	1/2000	1/500	
		1/1000	1/1000	1/250	
		1/500	1/500	1/120	
		1/250	1/250	1/100	
		1/120	1/120	1/60	
		1/100	1/100	1/50	
		(Standard)	1/60	1/50	1/48
			1/30	1/25	1/24
	1/15	1/12.5	1/12		
	1/7.5	1/6.25	1/6		
▼					
▲	Variable	(Upper limit)	1/9934	1/10014	1/9863
				~	
		(Standard)	1/60.00	1/50.00	1/48.00
				~	
▼		(Lower limit)	1/30.00	1/25.00	1/24.00

ND Filter Warning Display

In order to adjust the amount of light when you are shooting at a relatively bright location, the diameter of the iris may become extremely small, causing blurry effects to occur as a result.

This phenomenon is known as “small aperture diffraction”. You can make appropriate use of ND filters to prevent it from occurring.

This unit displays an ND filter warning when necessary to prompt you to select an appropriate ND filter.

- 1 Set [Main Menu] → [LCD/VF] → [Display Settings] → [ND Filter] to “On+Assist”.
(☞ P107 [ND Filter])
- 2 When the iris diameter becomes too small while adjusting the light intensity, or when an ND filter is used in a dimly-lit location, the ND filter display starts blinking.

Adjusting the White Balance

Adjust the white balance according to the color temperature of the lighting. You can select the adjustment mode according to the shooting conditions.

As the color of the light (color temperature) varies according to the light source, it is necessary to readjust the white balance when the main light source illuminating the subject changes.

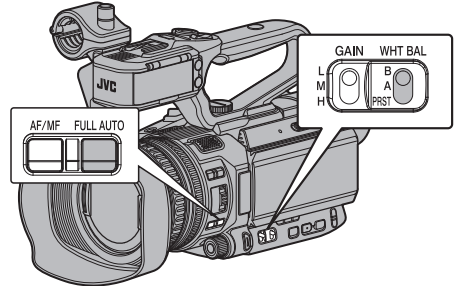

Automatic White Balance Mode (FAW: Fulltime Auto White balance)

- 1 Press and hold the [FULL AUTO] button to set Full Auto mode to off.
- 2 Assign “FAW” (Full Auto White Balance) to one of the three [WHT.BAL B/A/PRST] switches.
 - You can set the Full Auto White Balance feature to either “A”, “B”, or “PRST” in [Camera Function] → [FAW].
(☞ P97 [FAW])
 - If the position assigned with “FAW” is selected using the [WHT BAL B/A/PRST] switch, the Automatic White Balance mode is enabled and an appropriate white balance is automatically adjusted according to the color temperature of the lighting on the subject.

Caution :

- The accuracy of [FAW] is inferior to that of Auto White Balance.
- When the power of the camera recorder is turned on with the [FAW] mode selected, it takes about 15 seconds for the colors to stabilize.

Memo : _____

- Pressing and holding the [FULL AUTO] button to enter the Full Auto mode also activates the Automatic Shutter mode. In this case, the Iris, Gain and Shutter also enter into Auto mode forcibly.
- Switching of the white balance with the [WHT.BAL B/A/PRST] switch is disabled in the Full Auto mode.
- When [Main Menu] → [Camera Function] → [User Switch Set] → [AE/FAW Lock] is set to “AE/FAW”, the white balance when the user button that is assigned [AE/FAW Lock] is pressed can be fixed.
(☞ P99 [AE/FAW Lock])
- If [White Balance] is assigned to the user button, pressing the assigned user button will display the FAW Paint Adjustment screen.
(☞ P39 [Assignment of Functions to User Buttons])

FAW Paint Adjustment

You can fine-adjust the white balance that was automatically adjusted.

- 1 Select [Main Menu] → [Camera Process] → [White Balance] → [FAW Paint] and press the Set button (●).

The FAW Paint Adjustment screen appears.

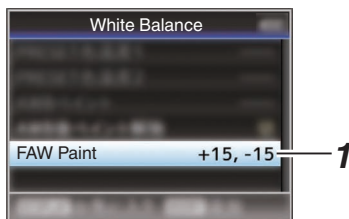

- 2 Adjust the R and B values.

Use the cross-shaped button (▲▼) to adjust R value and (◀▶) to adjust B value.

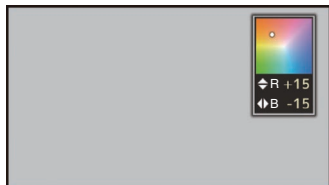

- 3 Press the Set button (●).

Returns to the [White Balance] screen.

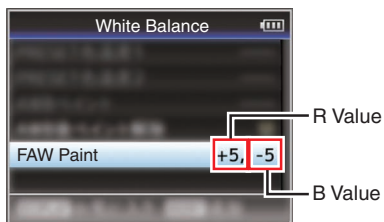

Manual White Balance Mode (Manual Switching)

- 1 Press and hold the [FULL AUTO] button to set Full Auto mode to off.

- Use the [WHT.BAL B/A/PRST] switch to select “PRST” (preset mode), “A” (memory A mode), or “B” (memory B mode).

Memo : _____

- You can set the Full Auto White Balance feature to either [A], [B], or [PRST] in [Camera Function] → [FAW].
(☞ P97 [FAW])
- In the FAW (Full Auto White Balance) mode, the color temperature of the video is sampled constantly and automatically to obtain the most appropriate white balance level.

Preset Mode (PRST)

- Two different color temperature settings are registered on this camera recorder. You can switch between them using the [AWB/9] button.
- * You can also use the user button assigned with [AWB] instead of the [AWB/9] button.
(☞ P98 [User Switch Set Item])

Default setting:

[Preset Temp.] : 3200K

[Alternative Temp.] : 5600K

- 1 Set the [WHT.BAL B/A/PRST] switch to “PRST”.

- 2 Press the [AWB/9] button.

- Press the [AWB/9] button to switch to a different color temperature.
 (“Preset Temp.” ↔ “Alternative Temp.”)

Setting the [Preset Temp.] or [Alternative Temp.] Values

You can change both the color temperature settings in the Preset mode in the menu.

1 Open the [Preset Temp.] or [Alternative Temp.] menu.

- Select [Main Menu] → [Camera Process] → [White Balance] → [Preset Temp.] and [Alternative Temp.], and press the Set button (●).
- The Color Temperature setting screen appears.

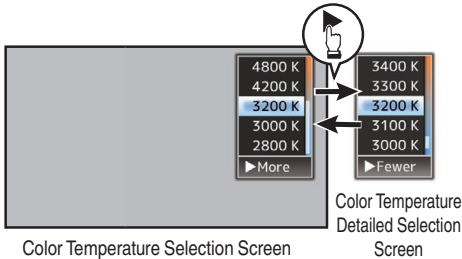

2 Select the color temperature.

- When selecting from a setting value (Color Temperature Selection screen), use the cross-shaped button (▲▼) to select the color temperature.
[Setting Values: 7500K, 6500K, 5600K, 5200K, 4800K, 4200K, 3200K, 3000K, 2800K]
- To select detailed values (Color Temperature Detailed Selection screen)
 - Press the cross-shaped button (▶) to display the Color Temperature Detailed Selection screen.
 - Use the cross-shaped button (▲▼) to select a color temperature.
[Setting Values: 2300K to 15000K (in 100K increments)]

Memo : _____

- Use the cross-shaped button (▶) to switch between the Color Temperature Selection screen and the Color Temperature Detailed Selection screen.
- If [White Balance] is assigned to the user button, pressing the assigned user button will display the Color Temperature Selection screen.
(☞ P39 [Assignment of Functions to User Buttons])

Memory A Mode (A), Memory B Mode (B)

- Set to the white balance saved in Memory A or Memory B.
- When the [WHT.BAL B/A/PRST] switch is set to “A” or “B”, press the [AWB/9] button to execute white balance. The white balance will be automatically adjusted and the adjusted value will be saved in Memory A or Memory B.
- * You can also use the user button assigned with [AWB] instead of the [AWB/9] button.
(☞ P98 [User Switch Set Item])

1 Prepare the camera recorder.

- ① Set the [POWER ON/OFF] switch to “ON”.
- ② Press the [IRIS] button to set to the Auto mode.
- ③ Press and hold the [FULL AUTO] button to set to “OFF”.

2 Set the [ND FILTER] switch according to the lighting.

(☞ P59 [Setting the ND Filter])

3 Set the [WHT.BAL B/A/PRST] switch to “A” or “B”.

4 Locate a place with similar lighting conditions as the object to be shot, place a white object near the center of the screen and zoom in to fill the screen with white.

5 Press the [AWB/9] button.

- The white detection frame appears when Auto White Balance is activated. Fill the frame with white completely.
- While Auto White is starting up, “A<●>” or “B<●>” appears on the screen. (● mark appears blinking)
- After the correct white balance is obtained, an estimated value of the current color temperature is displayed.

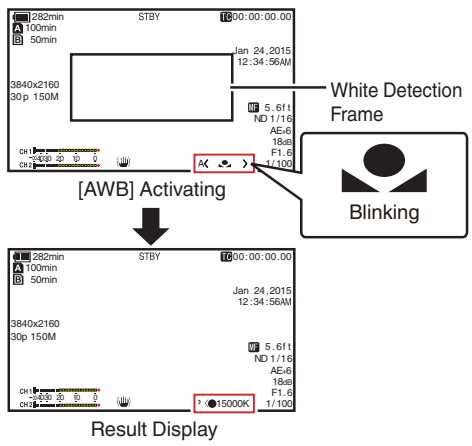

1 Select [Main Menu] → [Camera Process] → [White Balance] → [AWB Paint] and press the Set button (●).
The White Paint Adjustment screen appears.

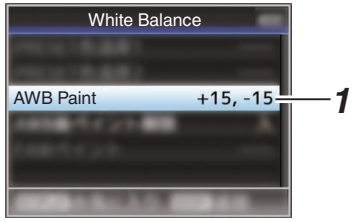

2 Adjust the R and B values.
Use the cross-shaped button (▲▼) to adjust R value and (◀▶) to adjust B value.



Caution :
 • Do not use highly reflective objects, such as metals. Doing so may result in improper white balance adjustment.
 • The Auto White function cannot provide optimum white balance with an object outside the adjustment range, for example when it contains only a single color or not enough white color.

Error Message

If the white balance adjustment is not correctly completed, one of the following messages will appear for about 3 seconds.

Message	Status
Auto White * NG: Object (*A or B)	Displayed when there is not enough white color on the object, or when the color temperature is not suitable. Use another white object and adjust the white balance again.
Auto White * Error: Low Light (*A or B)	Displayed when the lighting is dark. Increase the lighting and adjust the white balance again.
Auto White * Error: Over Light (*A or B)	Excessive illumination. Displayed when the lighting is too bright. Decrease the lighting and adjust the white balance again.

White Paint Adjustment

You can fine-tune the white balance saved in Memory A or Memory B.

3 Press the Set button (●).
Returns to the [White Balance] screen.

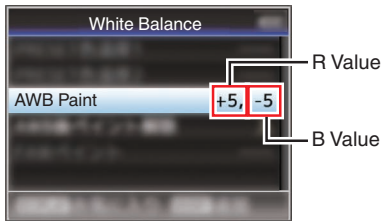

Memo :
 • Executing Auto White Balance will usually clear the White Paint Adjustment value. But when [Main Menu] → [Camera Process] → [White Balance] → [Clear Paint After AWB] is set to "Off", values will not be cleared even when Auto White Balance is executed. (P103 [Clear Paint After AWB])
 • If [White Balance] is assigned to the user button, pressing the assigned user button will display the AWB Paint Adjustment screen. (P39 [Assignment of Functions to User Buttons])

Adjusting the Camera Image

The picture quality of the camera can be set using the [Camera Process] menu.

As the adjustments are shown on the screen, you can adjust the values while checking the picture quality on the camera.

- [Detail]
- [Master Black]
- [Black Toe]
- [Knee]
- [White Clip]
- [Gamma]
- [WDR]
- [White Balance]
- [Color Matrix]
- [Color Gain]

Memo : _____

- For details of the respective items, see the [Camera Process] menu.
(☰ P100 [Camera Process Menu])

Using the Image Stabilizer

Reduces blurring of images due to camera shake.

1 Check whether the image stabilizer feature is turned ON or OFF.

If the image stabilizer icon (☰/☰) does not appear on the screen display, the image stabilizer function is OFF.

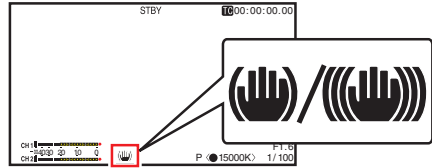

2 Press the [OIS/6] button to turn ON the image stabilizer feature (when image stabilizer feature is OFF).

The image stabilizer feature switches between ON and OFF with every press of the [OIS/6] button.

- OFF:
Use this setting when the camera recorder is secured, such as when using a tripod.
- ON:
Reduces blurring of images due to camera shake.

Memo : _____

- Select [Main Menu] → [Camera Function] → [OIS] → [Level] to set the correction level.
(☰ P96 [Level])
- Correction by this feature may not be sufficient when camera shake is too strong.
- “OIS” is assigned to the [OIS/6] button in factory default.
- “OIS” can also be assigned to other user buttons.
(☰ P39 [Assignment of Functions to User Buttons])

Audio Recording

You can record audio from the two channels (CH1/CH2) in synchronization with video images on this camera recorder.

Select from the four options below to record the audio.

- Built-in Microphone
- Microphone connected to [AUX] terminal
- Microphone connected to [INPUT1] terminal

HDL

- Microphone connected to [INPUT2] terminal

HDL

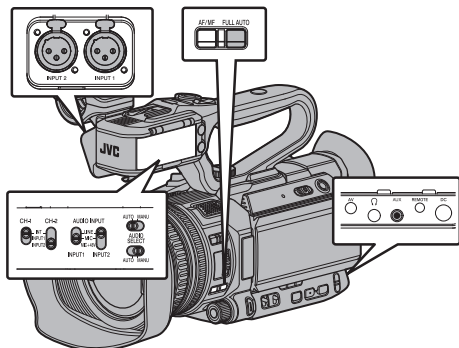

Selecting Audio to Be Recorded in Each Channel **HDL**

Select the audio to be recorded in CH1/CH2.

-	Switch Setting	Connected Devices
CH1	INT	<ul style="list-style-type: none"> • Built-in Microphone • Microphone connected to [AUX] terminal
	INPUT1	Microphone connected to [INPUT1] terminal
CH2	INT	<ul style="list-style-type: none"> • Built-in Microphone • Microphone connected to [AUX] terminal
	INPUT1	Microphone connected to [INPUT1] terminal
	INPUT2	Microphone connected to [INPUT2] terminal

- When CH1 or CH2 is set to “INT” and a microphone is connected to the [AUX] terminal, audio is recorded according to the setting in [Main Menu] → [A/V Set] → [Audio Set] → [CH1 INT]/[CH2 INT].

(P110 [CH1 INT])

(P110 [CH2 INT])

Memo : _____

- When the [AUX] terminal is not connected, [Main Menu] → [A/V Set] → [Audio Set] → [CH1 INT]/[CH2 INT] is fixed at “Int. Mic L”/“Int. Mic R” respectively.

Setting Input Channel to [INPUT1]/[INPUT2]

Select the audio to input to [INPUT1] and [INPUT2] terminals with the [INPUT1]/[INPUT2] mode switch.

Setting	Description
[LINE]	Use this setting when connecting to an audio device or other equipment. The reference input level is +4 dBu.
[MIC]	Use this setting when connecting to a dynamic microphone.
[MIC+48V]	Use this setting when connecting to a microphone (phantom microphone) that requires a +48 V power supply.

Memo : _____

- When “MIC” or “MIC+48V” is selected, set the reference input level in [Main Menu] → [A/V Set] → [Audio Set] → [Input1 Mic Ref.]/[Input2 Mic Ref.].
(P110 [Input1 Mic Ref./Input2 Mic Ref. **HDL**])

Caution : _____

- When connecting a device that does not require a +48 V power supply, make sure that it is not set to the “MIC+48V” position.
- When the [INPUT1]/[INPUT2] mode switch is set to “MIC”, make sure that a microphone is connected to the [INPUT1]/[INPUT2] terminal. If you increase the recording level when a microphone is not connected, noise from the input terminal may be recorded.
- When a microphone is not connected to the [INPUT1]/[INPUT2] terminal, set the [INPUT1]/[INPUT2] mode switch to “LINE” or adjust the volume with the [CH1]/[CH2] recording level adjustment knob.

Adjusting the Audio Recording Level

HDL

You can select to adjust the audio recording levels for the two channels (CH1/CH2) manually or automatically.

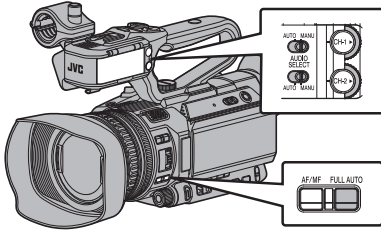

Manual Adjustment Mode (Manual Adjustment)

- Set the [CH1/CH2 AUTO/MANUAL] switch on the camera recorder to "MANUAL" to enter the manual adjustment mode, and use the [CH1]/[CH2] recording level adjustment knob to set the recording level.
- You can adjust the level manually during the recording, recording standby, and stop modes.

Memo : _____

- When the [FULL AUTO] button is set to "ON" and [Main Menu] → [A/V Set] → [Audio Set] → [Audio On FULL AUTO] is set to "Auto", the [CH1 AUTO/MANUAL]/[CH2 AUTO/MANUAL] selection switch is disabled. (The above setting is the factory default.)

Setting Input Channel to "INPUT1"/"INPUT2"

- 1 Set the [CH1/CH2 AUTO/MANUAL] selection switch to "MANUAL" for the channel to be adjusted manually.
- 2 Turn the corresponding [CH1]/[CH2] recording level adjustment knob to adjust the level.

Adjust such that the audio level meter does not light up at -2 dB even for loud sounds. (☞ P111 [Limiter Mode])

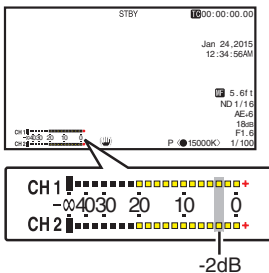

When the input channel is set to "INT" for both [CH1] and [CH2]

- 1 Set the [CH1 AUTO/MANUAL] selection switch to "MANUAL".
- 2 Turn the [CH1] recording level adjustment knob to adjust the level. When the built-in microphone and the [AUX] input terminal are used, the recording levels of [CH1] and [CH2] are interlocked. This is also effective when the [CH1 AUTO/MANUAL] selection switch is set to [CH2].

Memo : _____

- Select [Limiter Mode] or [Int. Mic Stereo Enhancer] in the menu to set the recording audio.
- For the reference level to be recorded to an SD card, set [Main Menu] → [A/V Set] → [Audio Set] → [Ref. Level] to "-20dB", "-18dB", or "-12dB". (common for CH1/CH2) (☞ P110 [Ref. Level])
- The operations of the [CH2] recording level adjustment knob and [CH2 AUTO/MANUAL] selection switch are disabled.
- When [Main Menu] → [A/V Set] → [Audio Set] → [CH1 INT] and [CH2 INT] are set to "Int. Mic L" and "AUX R" respectively, or set to "AUX L" and "Int. Mic R" respectively, the settings of the [CH1 AUTO/MANUAL] and [CH2 AUTO/MANUAL] selection switches become independent. In this case, the recording level settings of CH1 and CH2 are also independent.

Automatic Adjustment Mode

- Set the [CH1/CH2 AUTO/MANUAL] selection switch to "AUTO" or press and hold the [FULL AUTO] button set to "ON" to enter Automatic Adjustment mode. The audio recording level is set automatically according to the input level.
- When the [FULL AUTO] button is set to "ON", mode switching with the [CH1/CH2 AUTO/MANUAL] selection switch is disabled.

Memo : _____

- When [Main Menu] → [A/V Set] → [Audio Set] → [Limiter] is set to “Off” while in the automatic adjustment mode, the limiter operates at -6 dBFS.
- When [A/V Set] → [Audio Set] → [Audio On FULL AUTO] is set to “SW Set”, you can switch the audio recording mode with the [CH1/CH2 AUTO/MANUAL] selection switch on the camera recorder even if the [FULL AUTO] button is set to “ON”.
(☞ P112 [Audio On FULL AUTO])

Setting the Audio recording Level in the Main Menu

* Enabled only when the handle unit is not attached.

- 1 Select [Main Menu] → [A/V Set] → [Audio Set] → [Audio Level].
 - The [Audio Level] screen appears.

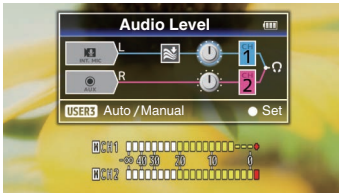

* The contents displayed on the screen vary depending on the various settings.

- 2 Select “Auto” or “Manual” using the [LOLUX/3] button.
 - If “Auto” is selected, the audio recording level will be automatically adjusted.
 - If “Manual” is selected, the volume appears on the screen. Use the cross-shaped button (◀▶) to adjust the volume.

Memo : _____

- When the [FULL AUTO] button is set to “On” and [Audio On FULL AUTO] in the menu is set to “Auto”, the audio recording level cannot be selected.
- If both CH1 and CH2 are set to the built-in microphone or to AUX, settings for CH2 will not be displayed, and the settings for CH1 will apply to CH2.

Monitoring Audio Sound During Recording Using a Headphone

You can check the recorded audio using a headphone.

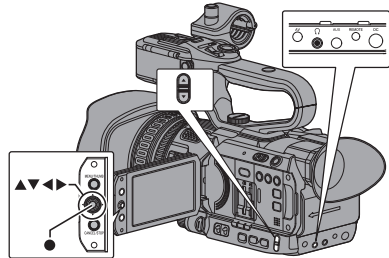

- 1 Connect the headphone.
- 2 Select [Main Menu] → [A/V Set] → [Audio Set] → [Monitor].
- 3 Adjust the monitor volume using the ▲ / ▼ volume buttons on the side of the camera recorder.

Memo : _____

- There is no audio output from the monitor speaker in Camera mode.
- Warning tone is output when there is an abnormality in the camera recorder or when the battery is low.
(☞ P174 [Warning Tone])
- You can set the volume of the warning tone in [Main Menu] → [A/V Set] → [Audio Set] → [Alarm Level]. (“Off”/“Low”/“High”)
(☞ P112 [Alarm Level])

Time Code and User's Bit

Time code and user's bit data are recorded with the video in this camera recorder.

The time code and user's bit are displayed on the viewfinder and LCD monitor during playback or recording. (Display screen)

Displaying Time Code and User's Bit

The time code and user's bit are displayed on the viewfinder and LCD monitor during playback or recording.

The display differs according to the menu settings.

- 1 Set [Main Menu] → [LCD/VF] → [Display Settings] → [TC/UB] to settings other than "Off".

(☞ P107 [TC/UB])

When "TC" or "UB" is selected, time code or user's bit data is displayed respectively on the display screen.

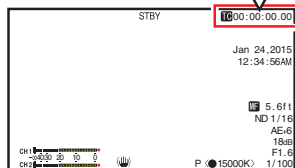

Time Code Operation Mode

Set the time code operation in [Main Menu] → [TC/UB] → [TC Generator].

(☞ P103 [TC Generator])

Setting	Description
Free Run	The time code operates in the run mode at all times regardless of the recording status. It continues to run even when the power of the camera recorder is turned off.
Rec Run	The time code operates in the run mode during recording. It continues to run in the order of the recorded clips as long as the SD card is not replaced. If the SD card is removed and recording is made on another card, time code will be recorded on the new card from where it was left off in the previous card.
Regen	The time code operates in the run mode during recording. When the SD card is replaced, the last time code recorded on the card is read and recorded on a new card so that the time code continues in running order. (☞ P69 [Setting Time Code])

Memo :

- When [Main Menu] → [System] → [Record Set] → [Rec Mode] is set to "Interval Rec" or "Frame Rec", and [TC Generator] is set to "Free Run", Rec Run is activated.
- When [Main Menu] → [System] → [Record Set] → [Record Format] → [A Format]/[B Format] is set to "AVCHD", and [Main Menu] → [System] → [Record Set] → [Rec Mode] is set to "Pre Rec", Free Run is activated. (☞ P115 [A Format]) (☞ P115 [B Format])

Setting Time Code Generator

Presetting the Time Code

Time code and user's bit data generated from the internal time code generator are recorded. This section describes how to set [TC/UB] → [TC Preset].

(☞ P103 [TC Preset])

Memo : _____

- When [Main Menu] → [System] → [Record Set] → [Record Format] → [A Frame Rate] is set to "50p", "50i" or "24p", setting for "Drop" will be disabled.

(☞ P115 [A Frame Rate])

- You can configure the setting without accessing the [TC/UB] menu screen.

(☞ P70 [Setting Time Code without Opening the Menu])

Required Settings Before Preset

1 Set [TC/UB] → [TC Generator] to "Rec Run" or "Free Run".

(☞ P103 [TC Generator])

- [Rec Run]:
Preset data in the time code generator operates in run mode during recording mode. Set this when recording continuous time code in connecting frames.
- [Free Run]:
Time code starts to operate in run mode from the preset time in the time code generator.

2 Select the framing mode for the time code generator (only when the frame rate setting is "60" or "30").

Set using [Main Menu] → [TC/UB] → [Drop Frame].

(☞ P104 [Drop Frame])

- [Drop]:
Sets the run mode of the time code generator to drop frame mode. Use this setting when placing emphasis on the recording time.
- [Non Drop]:
Sets the run mode of the time code generator to non-drop frame mode. Use this setting when placing emphasis on the number of frames.

Memo : _____

Drop frame/non-drop frame mode

- When [Main Menu] → [System] → [Record Set] → [Record Format] → [Frame Rate] is set to "60p", "60i", or "30p", the actual number of frames per second is approximately 59.94 (29.97). However, the time code processing standard is "60p", "60i", or "30p" frames. To make up for the frame number discrepancy, the drop frame mode (Drop) drops the 00 frame and 01 frame every minute except for minutes that are multiples of 10. However, in the case of "60p", the 00, 01, 02 and 03 frame are dropped.
- The non-drop frame mode (Non Drop) does not drop frames and ignores the discrepancy with the actual time.

Setting Time Code

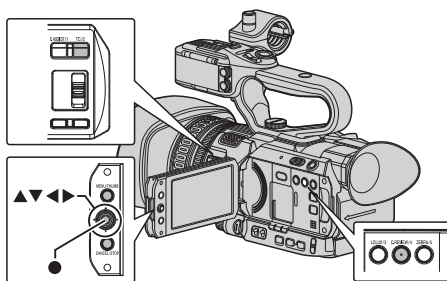

- 1 Select [Main Menu] → [TC/UB] → [TC Preset] and press the Set button (●).

(☞ P103 [TC Preset])

The [TC Preset] screen appears.

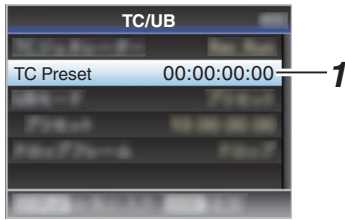

Memo : _____

- When [TC/UB] → [TC Generator] is set to “Regen”, the parameter is displayed as “Regen” and cannot be selected.
(☞ P103 [TC Generator])

- 2 Set the time code (hour, minute, second, frame).

Use the cross-shaped button (◀▶) to place the cursor at the item to set, then use the cross-shaped button (▲▼) to change the values.

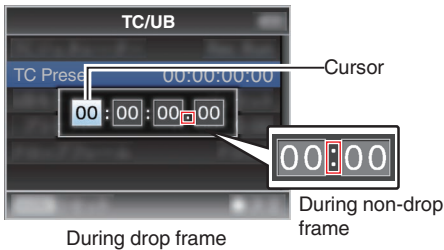

Memo : _____

- Press the [C.REVIEW/4] button to reset each digit to “0”. The cursor moves to the time digit (left).

- 3 Check the values and press the Set button (●).

- The time code is set and the screen returns to [TC/UB].
- To cancel the setting, press the [CANCEL] button.

- 4 Press the [MENU] button.
Returns to the normal screen.

Setting Time Code without Opening the Menu

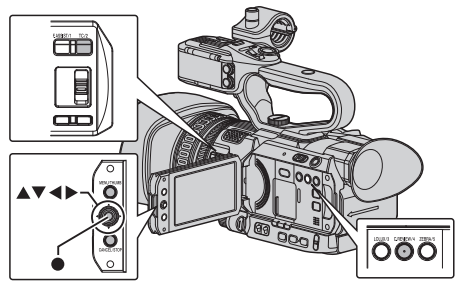

Memo : _____

- Settings cannot be made in the following cases.
 - [TC/UB] → [TC Generator] has been set to “Regen”.
 - Menu screen is displayed.
 - The camera recorder is not in the Camera mode.

Setting Time Code

- 1 Set [TC/UB] → [TC Generator] to “Rec Run” or “Free Run”.

(☞ P103 [TC Generator])

- 2 Press the [TC/2] button.

The [TC Preset] setting screen appears.

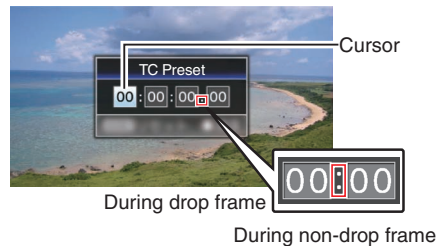

- 3 Set the time code (hour, minute, second, frame).

Use the cross-shaped button (◀▶) to place the cursor at the item to set, then use the cross-shaped button (▲▼) to change the values.

Memo : _____

- Press the [C.REVIEW/4] button to reset each digit to “0”. The cursor moves to the time digit (left).

4 Check the values and press the Set button (●).

- The time code is set and the screen returns to the normal screen.
- To cancel the setting, press the [CANCEL] button.

Caution :

- When the camera recorder is switched to Media mode during editing, editing will be canceled and the screen will close.
- When editing the time code, operation of the buttons that are set in [Main Menu] → [Camera Function] → [User Switch Set] is disabled. [C.REVIEW/4] functions as the number reset button.
(☞ P98 [User Switch Set Item])

Recording Time Code in Continuation of the Recorded Time Code on SD Card

This camera recorder is equipped with the time code reader.

1 Set [TC/UB] → [TC Generator] to “Regen”.

- When the camera recorder enters from recording standby mode to recording mode, it reads the time code already recorded on the SD card and records the new time code in continuation of that value.
- The same data as the user's bit already recorded on the SD card is recorded.

Memo :

- When [TC/UB] → [TC Generator] is set to “Regen”, the framing mode of the time code follows the settings in [TC/UB] → [Drop Frame] instead of the clip settings.
(☞ P104 [Drop Frame])

Setting the User's Bit

You can add the date, time or an 8-digit hexadecimal number as the user's bit to the recorded image.

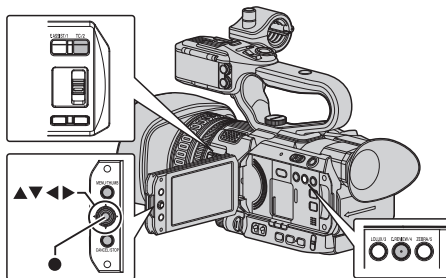

Selecting a Recording Mode

Recording date/time information to the user's bit

1 Set [Main Menu] → [TC/UB] → [UB Mode] to “Date” or “Time”, and press the Set button (●).

(☞ P103 [UB Mode])

The date or time information is recorded to the user's bit.

Memo :

- When “Date” or “Time” is set, [Preset] appears as “-” and cannot be set.
- “Time” is displayed in the 24-hour format.

Presetting the User's Bit

Recording arbitrary information (8-digit hexadecimal) to the user's bit

- 1 Set [Main Menu] → [TC/UB] → [UB Mode] to “Preset”, and press the Set button (●).

(☞ P103 [UB Mode])

The [UB Mode] setting screen appears.

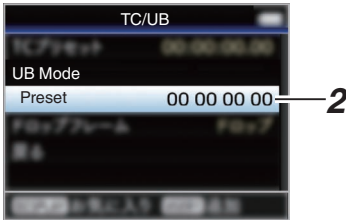

Memo : _____

- When [TC/UB] → [TC Generator] is set to “Regen”, the parameter is displayed as “Regen” and cannot be selected.
(☞ P103 [TC Generator])

- 2 Select [Main Menu] → [TC/UB] → “Preset” and press the Set button (●).

The [Preset] setting screen appears.

- 3 Use the cross-shaped button (◀▶) to place the cursor at the item to set, then use the cross-shaped button (▲▼) to change the values.

Numbers between 0 and 9 or alphabets between A and F can be specified for the user's bit.

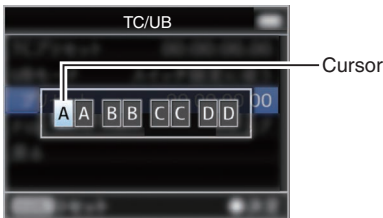

Memo : _____

- Press the [C.REVIEW/4] button to reset each digit to “0”. The cursor moves to the left.

- 4 Check the values and press the Set button (●).

- The user's bit is set and the screen returns to [TC/UB].
- To cancel the setting, press the [CANCEL] button.

- 5 Press the [MENU] button.

Returns to the normal screen.

Setting Zebra Pattern

When the luminance level range for displaying zebra patterns is specified, diagonal lines (zebra pattern) are displayed at areas with the specified luminance levels during shooting.

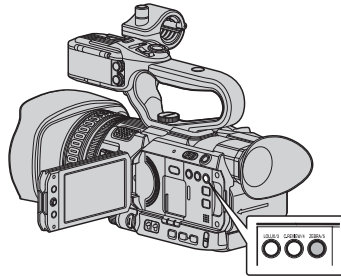

- 1 Set the zebra display pattern.

Select the display pattern in [LCD/VF] → [Shooting Assist] → [Zebra].

- 2 Specify the brightness (luminance) level range for displaying zebra pattern.

Specify the upper and lower limits of the luminance level in [LCD/VF] → [Shooting Assist] → [Zebra] → [Top] and [Bottom].

Item	Settings	Options
Top	Upper luminance limit for displaying [Zebra]	5% - 100%, Over (in 5 % increments)
Bottom	Lower luminance limit for displaying [Zebra]	0% - 100% (in 5 % increments)

- 3 Display the zebra pattern.

Press the [ZEBRA/5] button to display the zebra pattern in the specified range.



Memo : _____

- “Zebra” is assigned to the [ZEBRA/5] button in factory default.
- “Zebra” can also be assigned to other user buttons.
(☞ P39 [Assignment of Functions to User Buttons])

Viewing Recorded Videos Immediately (Clip Review)

You can check (review) the last recorded video clip on the screen.

However, the video clip cannot be played back if the settings of the camera recorder are different from the video format (Resolution/Frame Rate/Bit Rate/SD Aspect) of the clip.

(P115 [**A** Resolution])

(P115 [**A** Frame Rate])

(P115 [**A** Bit Rate])

(P116 [SD Aspect])

Memo : _____

- To use this function, assign “Clip Review” to any of the user buttons. “Clip Review” is assigned to the [C.REVIEW/4] button in factory default.
- “Clip Review” can also be assigned to other user buttons.
(P39 [Assignment of Functions to User Buttons])

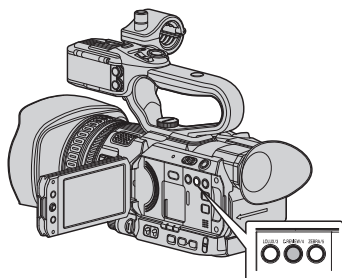

1 Press the user button assigned with the “Clip Review” function during standby (“STBY” is displayed).

Playback of the configured section starts.

Memo : _____

- The video clip is played back according to the setting in [Main Menu] → [Camera Function] → [User Switch Set] → [Clip Review]. By default setting (Last 5sec), the last 5 seconds of the clip is played back.
(P98 [Clip Review])
- When playback is complete, the camera recorder exits Clip Review and returns to “STBY” (recording standby) mode.

Caution : _____

- During Clip Review, only the [CANCEL] and [REC] buttons are enabled.
Press the [CANCEL] button to cancel clip review and return to “STBY” (recording standby) mode.
Press the [REC] button to cancel clip review and enter recording mode. It will take some time to start recording after the button is pressed.
- When the last clip is less than 5 seconds, the whole clip is played back.
- Only video clips in the currently selected slot can be reviewed.
- When there are no clips in the selected slot, Clip Review function is disabled.
- Clip Review is unavailable when Clip Continuous Rec is paused (“STBY**G**”, yellow text). To operate Clip Review, use the [CANCEL] button to set to “STBY**G**” (white text) first.
(P79 [Clip Continuous Rec])
- Clip Review is unavailable when the camera recorder is connected to an external equipment and the equipment is in recording state.
- Clip Review is unavailable when operating View Remote via network connection.
(P158 [View Remote Feature **200**])
- Clip Review does not function during live streaming. **200**
- Clip Review does not function while SDI Rec Trigger is in the REC state. **200**

Recording Simultaneously at Two Different Definitions

By setting [System] to “HD+Web”, you can record simultaneously at two different definitions.

- When HD+Web is selected:
Records a high-definition (HD) file to slot A and a web file to slot B at the same time.
Web files can be used as a proxy file for the HD file.

Memo :

- If a recordable SD card is inserted into only one of the slots, files will only be recorded to that slot.
- The [Rec Mode] is fixed at “Normal”.
- Clip Cutter Trig is disabled.
- [Slot Mode] cannot be selected.
- Clip Review can only be performed for slot A. (“No Media” appears if there is no card in slot A while a card is inserted into slot B.)
- Playback of web files is only possible from slot B when “HD+Web” is selected.

Dual Rec

- If both the slots are loaded with recordable cards in the Dual Rec mode ([Slot Mode] is set to “Dual”), pressing the [REC] button starts recording simultaneously to the media in both the slots.
- The clips recorded to the media in both the slots are identical, and two clips of the same content can be created only on this camera recorder. (P117 [Slot Mode])

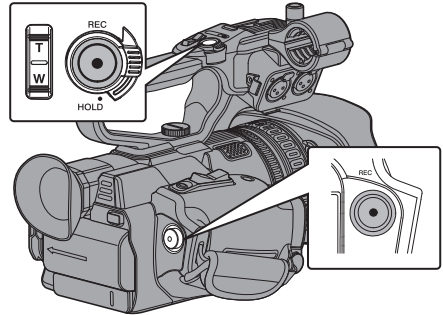

Series Rec

- Series Rec mode is specified in the factory default.
([Main Menu] → [System] → [Record Set] → [Slot Mode] is set to “Series”).
(P117 [Slot Mode])
- If both the slots are loaded with recordable cards, pressing the [REC] button starts recording only to the media in the selected slot. When the remaining space in the selected media runs out, recording continues by automatically activating the media in the other slot.
- There is no indication on the display screen when the Series Rec mode is set.

Setting to Dual Rec Mode

- 1 Set [Main Menu] → [System] → [Record Set] → [Slot Mode] to “Dual”.
(P117 [Slot Mode])
“DUAL” appears on the display screen.

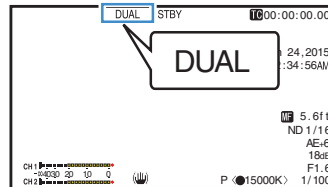

2 Start recording.

- Insert recordable media in both slots, and press the [REC] button.
- In the Dual Rec mode, recording to the media in both slots starts at the same time.
- Both the card slot marks turn red, and the status indicators of both the card slots also light up in red.

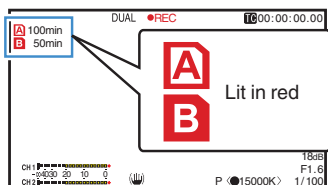

3 Stop recording.

- Press the [REC] button again.
- Recording to both slots stops, and both the card slot marks turn white.
- The same clips are recorded to both cards.

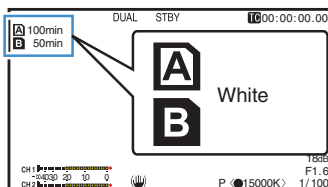

Memo :

- Available when [System] is set to "4K", "HD" or "SD".
(P115 [System])
- During recording in the Dual Rec mode, both the card slot marks light up in red.
- During recording in the Dual Rec mode to two cards with a different amount of remaining space, if the space of one card runs out, recording to both slots will stop automatically. After recording stops, recording automatically resumes for the card with remaining space. Although the clips are separated in this case, the clips can be seamlessly joined by arranging them on the timeline of the editing software since they are recorded seamlessly.
- If the last clip on the cards that are inserted in the two slots are different from each other, and the time code operating mode is set to "Regen", the Regen mode for the selected card slot will be enabled in the next recording.

Caution :

- To perform recording in the Dual Rec mode, it is recommended that you start recording by making use of two cards with the same capacity and from the formatted state.
- You can combine the use of the Dual Rec mode with a special recording mode. While in the Dual Rec mode, you can also set [Rec Mode] to "Normal", "Pre Rec", "Clip Continuous", "Interval Rec", or "Frame Rec". When [Main Menu] → [System] → [Record Set] → [Record Format] → [A]Format is set to "AVCHD", "Clip Continuous" cannot be selected.
(P78 [Special Recording])
(P116 [Rec Mode])
(P115 [A Format])
- When both slots are inserted with recordable cards, the Dual Rec (simultaneous recording) operation can be performed. If a recordable media is only inserted in one of the slots, you can also start recording with one card.
- In the Dual Rec mode, continuous recording by switching from one slot to another cannot be performed. Continuous recording will not be performed if a recordable media is inserted in a slot after recording to the other slot has started.
- When recording to one slot is in progress with the recorder set to the Dual Rec mode, inserting a recordable media to the other slot does not enable the Dual Rec operation. To perform the Dual Rec operation, stop recording temporarily (excluding pausing recording in the Clip Continuous Rec mode), and start again.
- When one of the cards is accidentally removed while recording is in progress in the Dual Rec mode, recording to the card in the other slot will continue. However, repair of the accidentally removed card by the recovery function may fail.
- If an error occurs on one of the cards while recording is in progress in the Dual Rec mode, recording of the erroneous card stops, while that of the other card continues.
- Operations on clips recorded in the Dual Rec mode, such as clip deletion in the Media mode or appending of OK marks, can only be performed on the card in the selected slot.

Backup Rec

- The Backup Rec mode allows you to make use of the media in slot B for backup recording by controlling the starting and stopping of recording in slot B without using the [REC] button.
- Start or stop the recording using [Main Menu] → [System] → [Record Set] → [Slot Mode] → [Backup Rec] or press the user button that is assigned with “Backup Trig”.
(☞ P117 [Slot Mode])
(☞ P98 [User Switch Set Item])

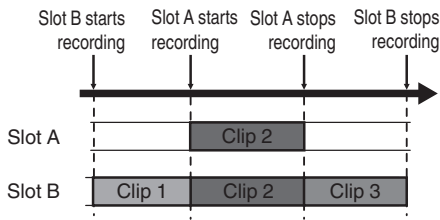

Memo : _____

- Available when [System] is set to “4K”, “HD” or “SD”.
(☞ P115 [System])
- During the Backup Rec mode (when [Slot Mode] is set to “Backup”), you can control recording to the 2 slots at different timings, and backup recording can only be performed on this camera recorder.
(☞ P117 [Slot Mode])
- You can record without worrying about missing the important scenes by setting slot B to be always recording (backup recording) and using the [REC] button to start/stop recording of only the required scenes in slot A.
- It is recommended to use a media with high capacity in slot B.

1 Set [Main Menu] → [System] → [Record Set] → [Slot Mode] to “Backup”.

(☞ P117 [Slot Mode])
“BACKUP” appears on the display screen.

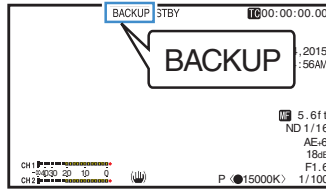

2 Start backup recording. (Backup recording into slot B)

- Select “REC” in [Main Menu] → [System] → [Record Set] → [Slot Mode] → [Backup Rec] and press the Set button (●).
- (☞ P117 [Slot Mode])
- You can also press the user button that is assigned with “Backup Trig”.
(☞ P98 [User Switch Set Item])
- Backup recording into slot B starts. (The characters “BACKUP” appear in red.)
- The card slot mark of slot B turns red (selected state), and the status indicator of slot B also blinks in red.

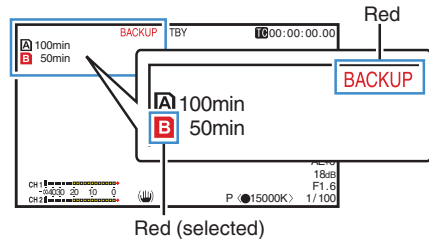

3 Start normal recording (normal recording into slot A)

- Press any of the [REC] buttons.
- Recording into the media in slot A starts. (The characters “●REC” appear in red.)
- The card icon of slot A turns red (unselected state), and the status indicator of slot A blinks in red.

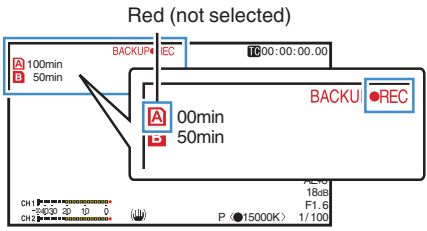

4 Stop normal recording.

- Press any of the [REC] buttons again.
- Recording to slot A stops, and the card slot mark of slot A turns white (unselected state).
- The characters “●REC” (red) changes back to “STBY” (white).
- The status indicator of slot A goes out.

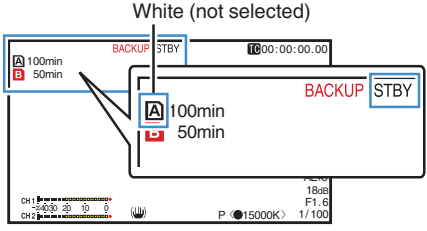

5 Stop backup recording.

- Select [STBY] in [Main Menu] → [System] → [Record Set] → [Slot Mode] → [Backup Rec] and press the Set button (●).
- (☞ P117 [Slot Mode])
- You can also press the user button that is assigned with “Backup Trig”.
- (☞ P98 [User Switch Set Item])
- Recording to slot B stops, and the card slot mark of slot B turns white (unselected state).
- The characters “BACKUP” changes back to white.
- The status indicator of slot B lights up in green.

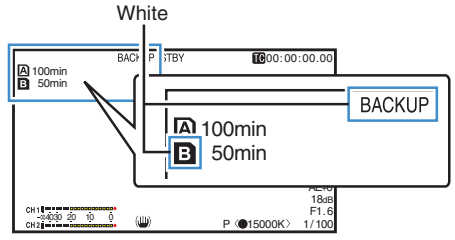

Memo : _____

- During backup recording, if the space of one card runs out, recording stops only for the card that is full.
- When recording to both slots is stopped, recording in the Regen mode will be enabled for the card slot in which recording started.
- When recording is started in the other slot while recording to one slot, the clip being recorded is split and simultaneous recording to the other card starts.
- When recording is stopped for either slot A or B while recording to both slots, the clip on the slot which is still recording is split.
- Although the clips are separated during recording the clips can be seamlessly joined by arranging them on the timeline of the editing software since they are recorded seamlessly.
- Clip Cutter Trig cannot be performed during backup recording.
(☞ P82 [Splitting the Clips Freely (Clip Cutter Trig)])
- When [Slot Mode] is set to “Backup”, [Rec Mode] can only be set to “Normal”.
(☞ P116 [Rec Mode])

Special Recording

Besides the normal recording mode, four special recording methods are available in this camera recorder. They are Pre Rec, Clip Continuous, Frame Rec and Interval Rec.

Select a mode from [Main Menu] → [System] → [Record Set] → [Rec Mode].

(☞ P116 [Rec Mode])

Memo : _____

- When [Main Menu] → [System] → [Record Set] → [Record Format] → [A Format] is set to "AVCHD", "Clip Continuous" cannot be selected.
(☞ P115 [A Format])
- When [Main Menu] → [System] → [Record Set] → [Record Format] → [System] is set to "HD+Web", special recording cannot be selected

Pre Rec

- By setting the number of seconds in the [Pre Rec Time], you can start recording video and audio before actual recording starts based on the [Pre Rec Time] setting.
- When starting actual recording while the camera recorder is in Recording Standby (STBY_P) mode, you can start recording a few seconds earlier based on the [Pre Rec Time] setting.
- Using Pre Rec allows you to record a complete event without missing the initial scenes even if you start the recording late.

Memo : _____

- Pre Rec Time can be set in [Main Menu] → [System] → [Record Set] → [Rec Mode] → [Pre Rec Time].

The following values can be selected depending on the setting of [Main Menu] → [System] → [Record Set] → [Record Format] → [System].

- When [System] is set to "4K":
Fixed at "5sec"
- When [System] is set to "HD" or "SD":
"5sec", "10sec" or "15sec"

(☞ P116 [Pre Rec Time])

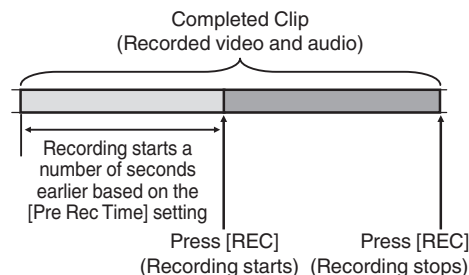

1 Set [Rec Mode] to "Pre Rec".

(☞ P116 [Rec Mode])

- Set [Main Menu] → [System] → [Record Set] → [Rec Mode] to "Pre Rec".
- The display changes ("STBY" → "STBY_P").

2 Press the [REC] button to start recording in Pre Rec mode.

- The display changes ("STBY_P" → "●REC_P") and the card slot status indicator lights up in red.
- Press the [REC] button again to pause recording. The display changes ("●REC_P" → "STBY_P") and the card slot status indicator lights up in green.

Caution : _____

- When the interval between start and stop recording is short, "STBY_P" may not be displayed immediately after recording is complete.
"●REC_P" → "STBY_P" ("STBY" blinks in red) → "STBY_P" is displayed.
- When the SD card becomes full during recording, recording stops and "STOP" is displayed.
- In the following cases, video and audio before the specified Pre Rec time may not be recorded even if recording starts.
 - Immediately after power on
 - Immediately after recording stops
 - Immediately after switching from Media mode to Camera mode
 - Immediately after setting [Rec Mode]
 - Immediately after the end of Clip Review
 - Immediately after changing file format
 - Immediately after changing video format

Clip Continuous Rec

- In normal recording, when the recording stops, the image, audio, and accompanying data from the start till the end of the recording are recorded as one “clip” on the SD card.
- This mode allows you to consolidate several rounds of “startstop recording” into one clip.

Example:

In normal recording, three clips are generated as Recording 1, Recording 2, and Recording 3. However, recording in this mode generates only one clip.

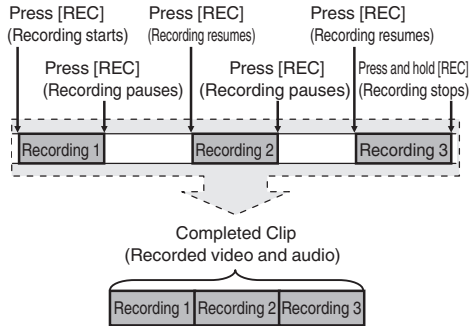

1 Set “Rec Mode” to “Clip Continuous”.

(P116 [Rec Mode])

- Set [Main Menu] → [System] → [Record Set] → [Rec Mode] to “Clip Continuous”.
- The display changes (“STBY” → “STBY \square ”).

2 Start recording. (Recording 1)

- Press the [REC] button to start recording in Clip Continuous mode.
- The display changes (“STBY \square ” → “●REC \square ”) and the card slot status indicator lights up in red.

3 Pause recording.

- Press the [REC] button again to pause recording. The display changes (“●REC \square ” → “STBY \square ” (yellow text)).
- The card slot status indicator remains lighted in red.

Memo :

- When the [CANCEL] button is pressed while the camera recorder is paused (STBY \square), the display changes (“STBY \square ” (yellow text) → “STBY \square ” (blinking yellow text) → “STBY \square ” (white text)), and a “clip” is generated. The card slot status indicator lights up in green.

4 Resume recording. (Recording 2)

- Press the [REC] button again to resume recording. The display changes (“STBY \square ” (yellow text) → “●REC \square ”).
- The card slot status indicator remains lighted in red.

5 Pause recording.

- Press the [REC] button again to pause recording. The display changes (“●REC \square ” → “STBY \square ” (yellow text)).
- The card slot status indicator remains lighted in red.

6 Resume recording. (Recording 3)

- Press the [REC] button again to resume recording. The display changes (“STBY \square ” (yellow text) → “●REC \square ”).
- The card slot status indicator remains lighted in red.

7 Press and hold the [REC] button.

- Recording stops and the display changes (“●REC \square ” → “STBY \square ”). A “clip” is generated.
- The card slot status indicator lights up in green.

8 Press the [REC] button again.

- The display changes (“STBY \square ” → “●REC \square ”) and the card slot status indicator lights up in red.
- A new “clip” is generated from here.

Memo : _____

- Clip Continuous Rec cannot be used in the following cases.
 - When [Main Menu] → [System] → [Record Set] → [System] is set to “HD” or “SD”, and [Format] is set to “AVCHD”
 - When [Main Menu] → [System] → [Record Set] → [System] is set to “HD+Web”
- The following operations cannot be performed while recording is paused (STBY \square , yellow text).
 - Clip Review operation (P73 [Viewing Recorded Videos Immediately (Clip Review)])
 - Switching SD card slots
 - Switching operation mode (P18 [Operation Modes])
- Files are split into sizes of 4 GB (or 30 minutes) regardless of the menu settings.

Caution : _____

- Do not remove the SD card during recording (●REC \square , red text) or recording pause (STBY \square , yellow text).
- To remove the SD card in the “Clip Continuous” mode, press the [CANCEL] button, check that “STBY \square ” (white text) is displayed and the card slot status indicator lights up in green before you remove the card.
- When the SD card becomes full during recording, recording stops and “STOP” is displayed.
- When the [POWER ON/OFF] switch is turned off during recording or recording pause, recording stops and power is cut off after a clip is generated.
- If the power is cut off due to low battery power, a proper clip may not be generated.
- When [A Format]/[B Format] in the [Main Menu] → [System] → [Record Set] → [Record Format] menu is set to “AVCHD”, Clip Continuous Rec cannot be performed. (P115 [A Format]) (P115 [B Format])

Frame Rec

In normal recording, when the recording stops, the image and accompanying data from the start till the end of the recording are recorded as one “clip” on the SD card.

In this mode, recording starts with every press of the [REC] button, and only the specified number of frames is recorded.

The recording can be written to the media as a single clip until it is stopped.

Memo : _____

- Audio will not be recorded.
- Until a specified amount of recordings is accumulated, the file cannot be written to the media.
- If the specified amount is not reached when recording is stopped, normal recording is performed and frames are added to the ending of the clip until the amount is reached. (Padding)
- After the specified number of frames is recorded and written to the media, recording will be performed until the same number is accumulated again.

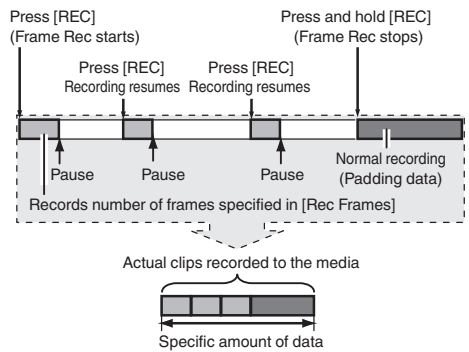

1 Set [Rec Mode] to “Frame Rec”.

- Set [Main Menu] → [System] → [Record Set] → [Rec Mode] to “Frame Rec”. (P116 [Rec Mode])
- The display changes (“STBY” → “STBY \square ”).

2 Set the number of frames to record in [Rec Frames].

- Set using [Main Menu] → [System] → [Record Set] → [Rec Mode] → [Rec Frames].
(☞ P116 [Rec Frames])

3 Start recording.

- Press the [REC] button to record only the number of frames specified in [Rec Frames] and pause.
- The display changes ("STBY" → "●REC" → "STBY" (yellow text)).
- The card slot status indicator lights up in green.

4 Repeat Frame Rec.

- Press the [REC] button again to record only the number of frames specified in [Rec Frames] and pause.
- The display changes ("STBY" → "●REC" → "STBY" (yellow text)).
- Frame Rec continues until the recording is stopped (step 5).

5 Press and hold the [REC] button.

- The card slot status indicator lights up in green.

Caution :

- Do not remove the SD card during recording ("●REC", red text) or recording pause ("STBY", yellow text).
- To remove the SD card during Frame Rec, press the [CANCEL] button, check that "STBY" (white text) is displayed and the card slot status indicator lights up in green before you remove the card.
- When [Main Menu] → [TC/UB] → [TC Generator] is set to "Free Run", the time code will be recorded in "Rec Run".
- Audio cannot be recorded. The audio level meter is grayed out.
(☞ P128 [Audio Level Meter])

Interval Rec

In normal recording, when the recording stops, the image and accompanying data from the start till the end of the recording are recorded as one "clip" on the SD card.

In this mode, recording and pause are performed repeatedly at the specified time interval. Only the specified number of frames is recorded.

The recording can be written to the media as a single clip until it is stopped.

Memo : _____

- Audio will not be recorded.
- Until a specified amount of recordings is accumulated, the file will not be written to the media.
- After the specified number of frames is recorded and written to the media, recording will be performed until the same number is accumulated again.
- If the specified amount is not reached when recording is stopped, normal recording is performed and frames are added to the ending of the clip until the amount is reached. (Padding)

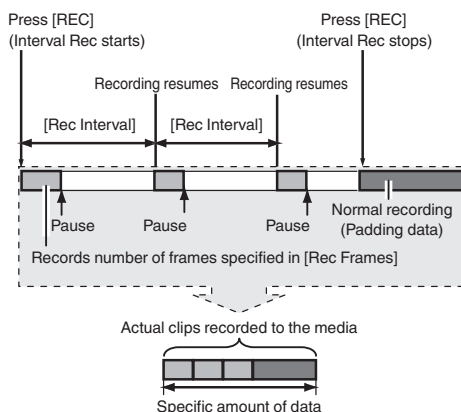

1 Set [Rec Mode] to "Interval Rec".

- Set [Main Menu] → [System] → [Record Set] → [Rec Mode] to "Interval Rec".

(☞ P116 [Rec Interval])

- The display changes ("STBY" → "STBY").

2 Set the number of frames to record in [Rec Frames].

Set using [Main Menu] → [System] → [Record Set] → [Rec Mode] → [Rec Frames].

(☞ P116 [Rec Frames])

3 Set the time interval to start recording in [Interval Rec].

Set using [Main Menu] → [System] → [Record Set] → [Rec Mode] → [Rec Interval].

(☞ P116 [Rec Interval])

4 Start recording.

- Press the [REC] button to record only the number of frames specified in [Rec Frames] and pause.
- After the specified time in [Rec Interval] has passed, recording starts again to record only the number of frames specified in [Rec Frames] and pause.
- Interval Rec continues until the recording is stopped.
The display changes (“STBY” → “●REC” → “STBY” (red text) → “●REC” → “STBY” (red text)).
- The card slot status indicator blinks in green.

5 Press and hold the [REC] button.

- The card slot status indicator lights up in green.
- The display becomes “STBY”.

Caution :

- Do not remove the SD card during recording (●REC, red text) or recording pause (STBY, yellow text).
- To remove the SD card during Interval Rec, press the [CANCEL] button, check that “STBY” (white text) is displayed and the card slot status indicator lights up in green before you remove the card.
- When [Main Menu] → [TC/UB] → [TC Generator] is set to “Free Run”, the time code will be recorded in “Rec Run”.
- Audio cannot be recorded. The audio level meter is grayed out.
(☞ P128 [Audio Level Meter])

Splitting the Clips Freely (Clip Cutter Trig)

You can split the clips freely without having to stop recording during shooting.

1 Assign the “Clip Cutter Trig” function to any of the user buttons.

(☞ P39 [Assignment of Functions to User Buttons])

2 Press the user button that is assigned with “Clip Cutter Trig” during shooting.

A clip cut icon (●✂) appears on the display screen for 3 seconds, and the clip is split.

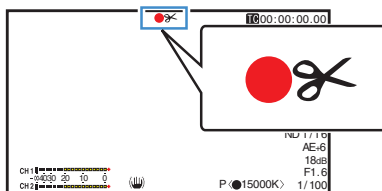

Memo :

- Clips cannot be split again for a few seconds after the operation is performed.
- This item cannot be used when [Slot Mode] is set to “Backup”.
- Available when [System] is set to “4K”, “HD” or “SD”.
(☞ P115 [System])
- This item cannot be used when [Rec Mode] is set to a value other than “Normal” or “Pre Rec”.
(☞ P116 [Rec Mode])
- The split clips are recorded seamlessly without interruptions in the video.

Playing Recorded Clips

To play back clips recorded on SD cards, switch to the Media mode.

Press and hold the [MODE] selection button in Camera mode to enter Media mode. A thumbnail screen of the clips recorded on the SD card is displayed.

You can play back the selected clip on the thumbnail screen.

Memo : _____

- When an SD card without any clips is inserted, "No Clips" is displayed.

Operation Buttons

Use the operation buttons, on the side control panel of the camera recorder or the LCD monitor, to operate the thumbnail screen.

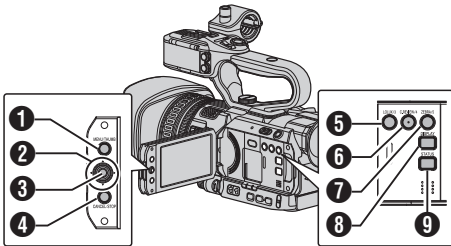

- [MENU/THUMB] Button**
 - Displays the menu.
 - Press this button to close the menu screen during menu display and return to the thumbnail screen.
- Cross-Shaped Button (▲▼◀▶)**
 - Moves the cursor.
- Set (Play) Button**
 - Sets the values and items. (Confirm)
 - Plays back the selected clip.
- [CANCEL] (Stop) Button**
 - Cancels settings and returns to the previous screen.
- [LOLUX/3] Button**
 - Switches the OK mark of the clip selected by the cursor.
 - If an OK mark has been appended, it will be deleted. Otherwise, an OK mark will be appended.

- [C.REVIEW/4] Button**
 - Switches the selection status of the clip selected by the cursor.
 - Clips being selected are displayed with check mark.
- [ZEBRA/5] Button**
 - Enters the action selection screen.
- [DISPLAY] Button**
 - Switches between the "Standard Screen" and "Detailed Screen".
- [STATUS] Button**
 - Displays the media information screen.

Thumbnail Screen

- "Standard Screen" and "Detailed Screen" are available. Use the [DISPLAY] button to switch between the screens.
- Thumbnails are displayed in order of recording from the oldest to most recent.

Standard screen



- SD Card Information**
 - Displays the status of the inserted SD card, selected SD card, write-protect switch, and the need for restoring.
 - Use the [SLOT A/B] switch to switch slots. Clips in slot A and B cannot be displayed at the same time.
 - A** : Write-protect switch of the SD card in slot A is set.
 - B!** : SD card in slot B needs to be restored or formatted, or is an unsupported SD card.

- Clip Mark**
 - Displays the clip information (properties).



- OK Mark**
 - Clip is appended with OK mark.

Memo : _____

- Clips appended with OK marks cannot be deleted on the camera recorder.
- When [Main Menu] → [System] → [Record Set] → [Record Format] → [A Format] is set to “AVCHD”, the OK mark indicates that the clip is protected.
(☞ P115 [A Format])

② Continued From Mark

This mark indicates that the current clip is continued from another SD card when recording is divided and made on several SD cards.

③ Uneditable Mark

- This mark indicates that an OK mark cannot be appended to or deleted from the clip, and the clip cannot be deleted.
- When [Main Menu] → [System] → [Record Set] → [Record Format] → [A Format] is set to “AVCHD”, clips that are not recorded on this camera recorder cannot be edited.

④ Continue Mark

This mark indicates that recording of the current clip is continued to another SD card when recording is divided and made on several SD cards.

⑤ Check Mark

- A green check mark is displayed when the clip is selected.
- Magenta and gray check marks are displayed in multiple selection mode.
(☞ P89 [Selecting and Performing Operations on Multiple Clips])

⑥ Cursor

Clip to be worked on. Use the cross-shaped button (▲▼◀▶) to move the cursor.

④ Thumbnail Substitution Display



- ① A clip with corrupted management information. It cannot be played back even if you press the Set (Play) button.
- ② A clip that cannot be played back nor displayed in thumbnail with the current video format settings. It cannot be played back even if you press the Set (Play) button.

Memo : _____

- Dependent on the settings for [Main Menu] → [System] → [Record Set] → [Record Format] → [System]/[A Resolution]/[B Resolution]/[A Frame Rate]/[B Frame Rate]/[A Bit Rate], and [B Bit Rate].
(☞ P115 [System])
(☞ P115 [A Resolution])
(☞ P116 [B Resolution])
(☞ P115 [A Frame Rate])
(☞ P116 [B Frame Rate])
(☞ P115 [A Bit Rate])
(☞ P116 [B Bit Rate])
- When [Record Format] → [A Format] is set to “AVCHD”, you may not be able to play back files recorded on a camera recorder other than the GY-HM200 and GY-HM170 series. If a file cannot be played back, the above thumbnail substitution display ② is displayed.

⑤ Clip Name

The file name (clip number) of the selected clip is displayed.

⑥ Operation Guide

- Displays a guide for the current operation buttons.
- The action selection screen is displayed when the User 5 ([ZEBRA/5]) button is pressed.
(☞ P85 [Actions])

⑦ Recording Start Time

Displays the recording start time of the clip.

Memo : _____

- The date/time display is dependent on the [LCD/VF] → [Display Settings] → [Date Style]/[Time Style] settings in the [Main Menu] screen.
(☞ P108 [Date Style])
(☞ P108 [Time Style])

⑧ Scroll Bar

- Indicates the scroll position.
- Black space below the scroll bar (white) indicates that there are more pages.
- When the scroll bar (white) is at the bottom, this indicates the last page.

⑨ Remaining Battery Power

(☞ P31 [Power Status Display])

⑩ Number of Clips

- If none of the clips are selected, the “running number/total number of clips” of the clip to be displayed appears.
- Even if only one clip is selected, the number of selected clips in the current slot is displayed.

- 11 Network Connection Icon **200**
- The network connection status is displayed when [Main Menu] → [System] → [Network] is set to “On”.
This icon is not displayed when “Off” is selected.
(☞ P 130 [Network Connection Icon **200**])

Detailed screen

* Items that are common with the Standard screen will not be described. Refer to “[Standard screen] (☞ P 83)”.

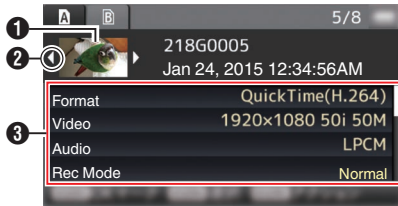

- 1 Thumbnail
Thumbnail of the clip selected by the cursor. Use the cross-shaped button (◀▶) to move the cursor.
- 2 Scroll Mark (◀▶)
- If there are previous clips, ◀ appears on the left.
 - If there are more clips, ▶ appears on the right.
 - The marks will not be displayed if there are no clips before and after the current clip.
- 3 Metadata
Metadata of the clip pointed by the cursor. You can use the cross-shaped button (▲▼) to scroll.

Actions

The action selection screen is displayed when the User 5 ([ZEBRA/5]) button is pressed.

The following operations can be performed.

Item	Description
Select All Clips	Selects all clips.
Select OK Marked	Selects all clips appended with OK mark.
Select Range	Specifies the range when selecting multiple clips. (☞ P 89 [Selecting Multiple Clips Randomly])
Deselect All	Clears all clip selections.
Add OK Mark	Appends an OK mark. <ul style="list-style-type: none"> This Clip: Appends an OK mark to the clip pointed by the cursor. Selected Clips: Appends an OK mark to the clips selected (appended with check mark). All Clips: Appends an OK mark to all clips.
Delete OK Mark	Deletes the OK mark. <ul style="list-style-type: none"> This Clip: Deletes the OK mark of the clip pointed by the cursor. Selected Clips: Deletes the OK mark of the clips selected (appended with check mark). All Clips: Deletes the OK mark of all clips.

Item	Description
FTP Upload	Uploads a clip to the FTP server. <ul style="list-style-type: none"> • This Clip: Uploads the clip pointed by the cursor. • Selected Clips: Uploads the clips selected (appended with check mark). • All Clips: Uploads all clips.
Delete Clips	Deletes clip. However, clips with OK mark cannot be deleted. <ul style="list-style-type: none"> • This Clip: Deletes the clip pointed by the cursor. • Selected Clips: Deletes the clips selected (appended with check mark). • All Clips: Deletes all clips.
Trim This Clip	Trims the clip pointed by the cursor.

Memo :

- The object of action is the clip of the current slot being displayed.
- [Selected Clips] cannot be performed if there are no selected (appended with check mark) clips.
- [This Clip] cannot be performed if there are more than one selected (appended with check mark) clips.
- If the write-protect switch of an SD card is set, OK mark cannot be appended or deleted, and the clips cannot be deleted and trimmed.

Playing back

Use the operation buttons on the side control panel of the camera recorder to play back.

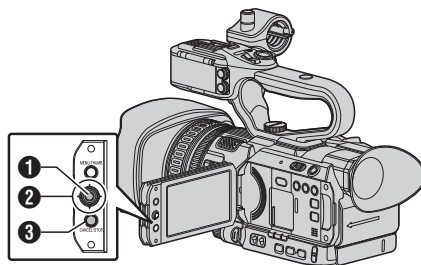

1 Set Button (●)

- Plays back/pauses the clip pointed by the cursor.
- You can press the cross-shaped button (◀▶) to perform frame-by-frame forward playback during pause mode.

2 Cross-shaped Button (▲▼◀▶)

- [▲/▼] Button: Skips in the reverse or forward direction.
- [◀/▶] Button:
 - During Playback: Fast forwards in the reverse or forward direction.
 - While paused: Frame-by-frame playback in the reverse or forward direction.

3 [CANCEL/STOP] Cancel Button

Stops playback.

1 In the thumbnail screen, move the cursor to the clip to be played back.

Move the cursor to the clip to be played back using the cross-shaped button (▲▼◀▶).

2 Press the Set button (●).

Playback of the selected clip starts.

Audio Output during Playback

- You can confirm the playback sound from the monitor speaker, or the headphone connected to the [] terminal. When a headphone is connected to the [] terminal, sound cannot be output from the monitor speaker. (P139 [Connecting the Headphone])
- Adjust the volume of the monitor speaker and headphone using the ▲ / ▼ volume buttons on the side of the camera recorder.

Time Code Playback

Time code or user's bit recorded on an SD card can be displayed on the LCD monitor and viewfinder.

Memo : _____

- The time code is also superimposed on the video signal output from the [SDI OUT] terminal.
200
- If a section without time code is played back, the time code will stop. However, playback will continue.

Displaying Information during Shooting

Pressing the [DISPLAY] button during playback displays the display screen.

Pressing the [OIS/6] button each time changes the shooting information displayed (camera information display and hide display).

- Camera information display displays only information of Gain, Iris, Shutter and White Balance that have been recorded.

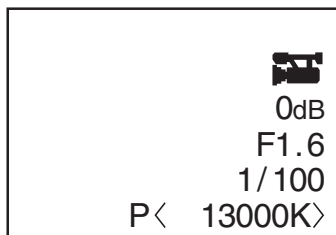

Camera Information Display

Memo : _____

- When [System] → [Record Set] → [Record Format] → System is set to "HD+Web", only SD or web files can be played back from slot B. In this case, files up-converted into the HD size are played back in the simple mode.
- Trimming information is displayed while trimming is in progress. In this case, pressing the [OIS/6] button does not switch the display.

Deleting Clips

Delete clip.

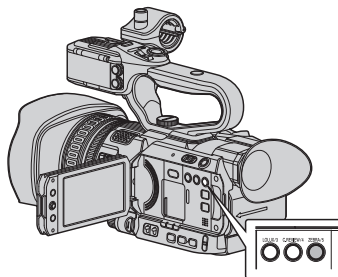

Memo : _____

- Clips appended with OK marks cannot be deleted on the camera recorder.
- Read-only clips can be deleted on a PC.

Deleting One Clip

Delete the clip (one clip) pointed by the cursor in [Delete Clips] → [This Clip] in the menu.

Memo : _____

- Clips with OK mark cannot be deleted.

During Thumbnail Screen

- 1 **Move the cursor to the clip to be deleted.**
Move the cursor to the clip to be deleted using the cross-shaped button (▲▼◀▶).

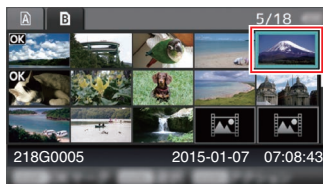

- 2 **Press the [ZEBRA/5] button.**
The action selection screen is displayed.

- 3 Select [Delete Clips] → [This Clip] and press the Set button (●).

A screen to confirm deletion appears.

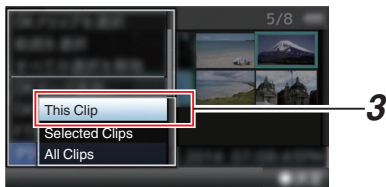

- 4 Select [Delete] using the cross-shaped button (▲▼), and press the Set button (●). Deleting starts.

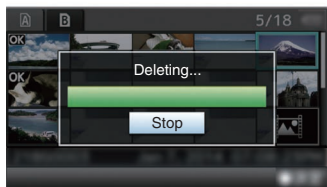
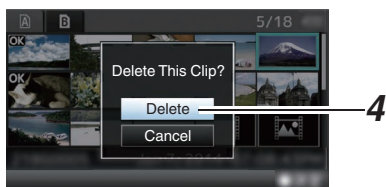

Selecting and Deleting Multiple Clips

To select and delete multiple clips, refer to "[Selecting and Performing Operations on Multiple Clips] (P 89)".

Deleting All Clips

Delete all clips that are displayed.

- 1 Press the [ZEBRA/5] button.
The action selection screen is displayed.
- 2 Select [Delete Clips] → [All Clips].
A screen to confirm deletion appears.
- 3 Select [Delete] and press the Set button (●).
Deleting starts.

Memo : _____

- The time taken to delete clips depends on the number of clips to be deleted.

Appending/Deleting OK Mark

- You can append OK marks to the clips for important scenes.
- Clips appended with OK marks cannot be deleted, thus protecting the important clips.
- When the camera recorder is in Media mode, you can delete the OK marks appended during recording, or append/delete OK marks after shooting.

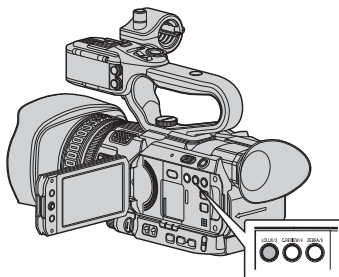

During Thumbnail Screen

- 1 Press the [LOLUX/3] button.
 - If the clip does not have an OK mark, an OK mark will be appended.
 - If the clip is appended with an OK mark, the OK mark will be deleted.

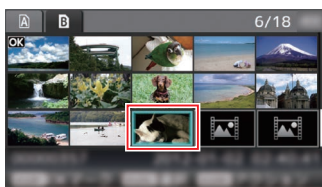

During Playback or Pause Screen

1 Press [LOLUX/3] button during clip playback.

- If the clip does not have an OK mark, an OK mark will be appended.
- If the clip is appended with an OK mark, the OK mark will be deleted.



Memo : _____

- The clip pauses when an OK mark is appended or deleted during playback.

Appending/Deleting OK Mark of Multiple Clips

To select and append/delete OK mark for multiple clips, refer to “[Selecting and Performing Operations on Multiple Clips] (P 89)”.

Selecting and Performing Operations on Multiple Clips

- Multiple clips can be selected during thumbnail screen or playback screen display.
- After selecting multiple clips, perform appending/deleting of OK mark, deleting of clips using the action selection screen.
- After selecting multiple clips, the selections will be canceled by the following operations.
 - When [Deselect All] in the action menu is selected
 - When exiting Media mode from the thumbnail screen
 - When removing the SD card
 - When switching the slot in use

Selecting Multiple Clips Randomly

- 1 Move the cursor to a clip without a check mark, and press the [C.REVIEW/4] button. A green check mark appears on the clip.

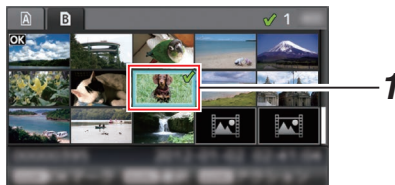

2 Repeat Step 1 to select multiple clips.

- Multiple clips can be selected.
- Press the [ZEBRA/5] button while the multiple clips are selected.
 - Appends OK mark together: [Add OK Mark] → [Selected Clips]
 - Deletes OK mark together: [Delete OK Mark] → [Selected Clips]
 - Uploading selected clips to the FTP server together: [FTP Upload] → [Selected Clips]
 - Deletes selected clips together: [Delete Clips] → [Selected Clips]

Memo : _____

- Selecting clips appended with check mark and pressing the [C.REVIEW/4] button will cancel the selection.
- If the operation is performed on multiple clips at the same time, a progress bar appears. You can stop the operation by pressing the Set button (●) while the operation is in progress. However, it is not possible to undo operations that are completed.

Selecting Multiple Clips Consecutively

- 1 Press the [ZEBRA/5] button.
- 2 Select “Select Range” in the action selection screen, and press the Set button (●).

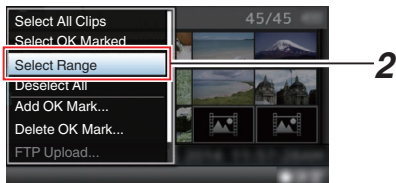

- 3 Move the cursor to the beginning (or end) of the range for multiple selection, and press the Set button (●).

- 4 Move the cursor to the other end of the range.

- Magenta check marks appear on the clips within the range. (Including clips that were already selected.)
- Gray check marks appear on selected clips that are outside the range.

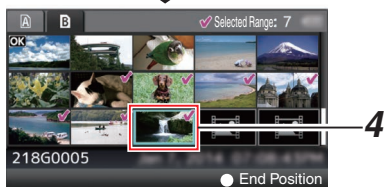
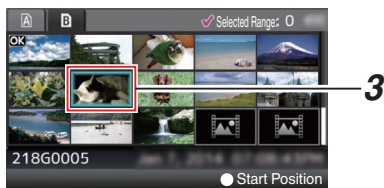

- 5 Press the Set button (●) to confirm the range.

- The check marks change from magenta to green.
- Pressing the [ZEBRA/5] button while the multiple clips are selected displays the action selection screen. The following operations can be performed.
 - Appends OK mark together:
[Add OK Mark] → [Selected Clips]
 - Deletes OK mark together:
[Delete OK Mark] → [Selected Clips]
 - Uploading selected clips to the FTP server together:
[FTP Upload] → [Selected Clips]
 - Deletes selected clips together:
[Delete Clips] → [Selected Clips]

Memo : _____

- Selecting clips appended with check mark and pressing the [C.REVIEW/4] button will cancel the selection.
- If the operation is performed on multiple clips at the same time, a progress bar appears. You can stop the operation by pressing the Set button (●) while the operation is in progress. However, it is not possible to undo operations that are completed.

Trimming Recorded Clips

You can extract (trim) the necessary parts of a clip recorded in the SD card.

The trimmed clip is saved as a new file on the same SD card as the original clip. No changes are made to the original clip.

1 Switch to Media mode.

Switch the mode using the [MODE] selection button on the side control panel.

2 Move the cursor to the clip to be trimmed.

Move the cursor to the clip to be trimmed using the cross-shaped button (▲▼◀▶).

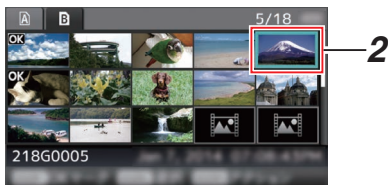

3 Press the [ZEBRA/5] button.

The action selection screen is displayed.

4 Select [Trim This Clip], and press the Set button (●).

Playback of the selected clip starts.

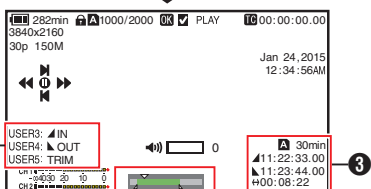
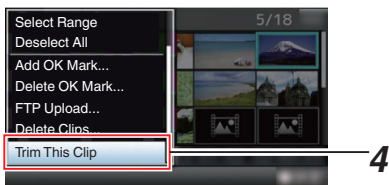

1 Guide

Operation guide

2 Position bar

- ▼ : Current position of the video
- ▲ : Position to start trimming (in point)
- ▾ : Position to end trimming (out point)

3 Trimming information

- A or B : Indicates the available space in the storage media (A or B)
- ▲ : Indicates the time code of the in point
- ▾ : Indicates the time code of the out point
- ↔ : Indicates the duration from the in point to the out point

Memo : _____

- The trimmed clip will be saved to the same card slot as that of the original clip.
- [Duration] appears in yellow in the following durations. Trimming cannot be performed in this case.
 - When [Main Menu] → [System] → [Record Set] → [Record Format] → [System] is set to "4K": 3 minutes or longer; setting other than "4K": 10 minutes or longer.
- [Duration] appears in yellow if the duration is longer than the recordable time on the storage media. Trimming cannot be performed in this case.
- When trimming starts, the display switches to the Media Display 2 screen.

5 Specify the in point.

- Operate buttons such as ◀▶ or ▲/▼ to move the video to the in point.
(P86 [Playing back])
- Specify the in point by pressing the [LOLUX/3] button at the point you want to start trimming.

6 Specify the out point.

- Operate buttons such as ◀▶ or ▲/▼ to move the video to the out point.
(P86 [Playing back])
- Specify the out point by pressing the [C.REVIEW/4] button at the point you want to end trimming.

7 Perform trimming.

Press the [ZEBRA/5] button to perform trimming.

Memo : _____

- While trimming is in progress, you can press the [CANCEL] button to return to the thumbnail screen.
- While trimming is in progress, you can press the [DISPLAY] button to switch the display, but the trimming information is displayed at all times.
- When trimming the in and out point, the in point trimmed may be up to one second before the specified in point and the out point trimmed may be up to one second behind the specified out point.

Basic Operations in Menu Screen

- Press the [MENU/THUMB] button on the LCD monitor to display the menu screen on the LCD monitor and viewfinder.
- Various settings for shooting and playback can be configured on the menu screen.
- There are two types of menu screens - [Main Menu] and [Favorites Menu].
- [Main Menu] contains all the setting items of the camera recorder, classified according to functions and uses, while [Favorites Menu] allows users to customize the menu items freely. (☞ P123 [Adding/Editing Frequently Used Menu Items (Favorites Menu)])
- The operating procedures and main screen displays are the same for both menus.
- The menu screen can also be displayed on external monitors connected to the video signal output terminal. (☞ P109 [Display On TV])

Operation Buttons

Use the operation buttons on the side control panel of the camera recorder or the buttons on the LCD monitor to operate the menu.

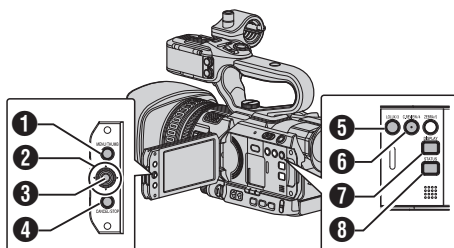

- 1 [MENU/THUMB] Button
 - Displays the menu screen. The [Main Menu] screen is displayed by default.
 - During normal usage, [Main Menu] is displayed if the previous menu operation ended at [Main Menu], and [Favorites Menu] if the previous menu operation ended at [Favorites Menu].
 - Press this button to close the menu screen during menu display and return to the normal screen.
 - Pressing and holding down the button while the menu is displayed switches the [Main Menu] screen to the [Favorites Menu] or vice versa.
- 2 Cross-shaped Button (▲▼◀▶)
 - ▲ : Moves the cursor upward.
 - ▼ : Moves the cursor downward.
 - ◀ : Moves back to the previous item.
 - ▶ : Moves forward to the next item.
- 3 Set Button (●)
 - Sets the values and items.
- 4 [CANCEL] Button
 - Cancels settings and returns to the previous screen.
- 5 [LOLUX/3] Button
 - Adds the selected menu or submenu item to the [Favorites Menu]. (☞ P123 [Adding/Editing Frequently Used Menu Items (Favorites Menu)])
- 6 [C.REVIEW/4] Button
 - Resets settings in the [TC Preset] or [UB Preset] setting screen. This button is disabled in other screens.
- 7 [DISPLAY] Button
 - Switches between the [Main Menu] and [Favorites Menu] screens.
- 8 [STATUS] Button
 - Displays a simple Help menu. Simple Help appears only when the selected menu item supports this function.

Display and Description of the Menu Screen

Selecting Menu Items

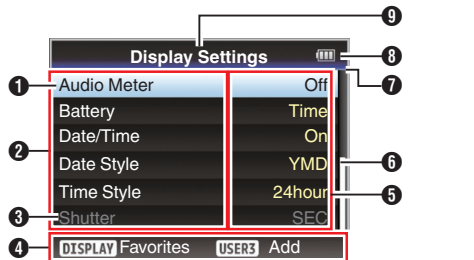

- 1 Cursor
Indicates the selected item. Use the cross-shaped button (▲▼) to move the cursor
- 2 Menu Item
 - Displays the names of the menu item and sub-menu.
 - Menu items with [...] after them indicates that there is a sub-menu to access.
- 3 Fixed Item
Items that cannot be changed are displayed in gray and cannot be selected.
- 4 Operation Guide
Guide for the current operation buttons.
- 5 Setting Value
Setting values for the menu items.
For menus with sub-menus, values are not displayed.
- 6 Scroll Bar
Indicates the scroll position.
- 7 Header
Indicates the current menu type with the line color.
Blue : [Main Menu] Screen
Green : [Favorites Menu] (Operation screen)
Magenta : [Favorites Menu] (Editing screen)
- 8 Remaining Battery Power
(P31 [Power Status Display])

Memo : _____

- If the supplied battery (or equivalent battery sold separately) is not used, the battery mark which indicates the battery level may not appear.

- 9 Menu Title
Title of the currently displayed menu.

Changing Setting Values

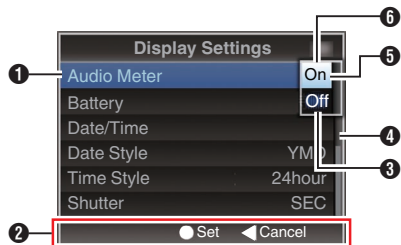

- 1 Menu Item to Change
Menu item to be changed.
A list of setting values 6 appears in a pop-up.
- 2 Operation Guide
Guide for the current operation buttons.
- 3 Setting Values Before Change
Setting values before changing. The background of the item is displayed in blue.
- 4 Scroll Bar
Indicates the scroll position.
- 5 Cursor
Indicates the selected item. Use the cross-shaped button (▲▼) to move the cursor
- 6 List of Setting Values
 - A pop-up displaying a list of setting values for selection.
 - The height of the pop-up depends on the number of settings available. Use the scroll bar 4 to confirm the current display status.

Text Input with Software Keyboard

Use the software keyboard to enter the [Setup File] subname, [Clip Name Prefix], and the settings under [Network] → [Settings].

Entering a subname

(☞ P136 [Configuring Setup Files])

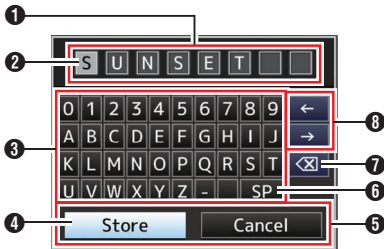

Entering the [Clip Name Prefix]

(☞ P118 [Clip Name Prefix])

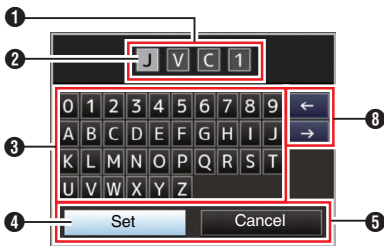

Settings under [Network] → [Settings]

The keyboard displayed varies according to the settings.

(☞ P118 [Network/Settings Item 200])

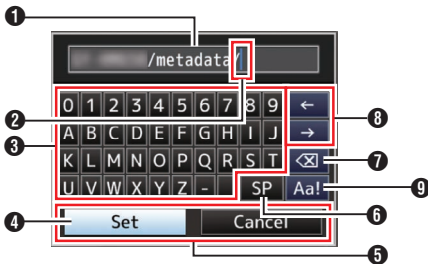

- 1 Character Entry Field
 - Field for entering the title.
 - You can enter up to 8 characters for the [Setup File] subname or up to 4 characters for the [Clip Name Prefix].
- 2 Character Cursor

Select a character using the key cursor 4, and press the Set button (●) to input the selected character at the position of the character cursor. The character cursor moves to the next position on the right each time a character is input. The cursor can be moved using the arrow keys 8.
- 3 Character Keys

Use the cross-shaped button (▲▼◀▶) to move the key cursor 4 to the character you want to enter.
- 4 Key Cursor

Indicates the currently selected character or item. Use the cross-shaped button (▲▼◀▶) to move the cursor.
- 5 Confirmation Buttons
 - Select [Set]/[Store] and press the Set button (●) to confirm the title.
 - Select [Cancel] and press the Set button (●) on the side control panel of the camera recorder to abort character input and return to the previous screen.
- 6 [SP] Space Key

Select [SP] and press the Set button (●) on the side control panel of the camera recorder to enter a space at the current position of the character cursor 2.
- 7 [⌫] Backspace Key

Select [⌫] and press the Set button (●) on the side control panel of the camera recorder to delete the character on the left of the character cursor 2.
- 8 Arrow Keys

Moves the position of the character cursor 2.
- 9 Character Switch Button

Switches the character buttons 3 to the upper case, lower case, and symbols.

Menu Screen Hierarchical Chart

[Main Menu...]	(P 95)	[Color Matrix]	(P 102)
├─ [Camera Function...]	(P 96)	├─ [Color Gain]	(P 102)
│ ─ [Bars]	(P 96)	└─ [Reset Process]	(P 102)
│ ─ [OIS]	(P 96)	[TC/UB...]	(P 103)
│ ─ [Flicker Correction]	(P 96)	├─ [TC Generator]	(P 103)
│ ─ [Shutter]	(P 96)	├─ [TC Preset]	(P 103)
│ ─ [AE Speed]	(P 96)	├─ [UB Mode]	(P 103)
│ ─ [AGC Limit]	(P 96)	└─ [Drop Frame]	(P 104)
│ ─ [Auto Iris Limit (OPEN)]	(P 96)	[LCD/VF...]	(P 104)
│ ─ [Auto Iris Limit (CLOSE)]	(P 96)	├─ [Shooting Assist...]	(P 104)
│ ─ [EEI Limit]	(P 96)	├─ [Marker Settings...]	(P 104)
│ ─ [Smooth Trans]	(P 96)	├─ [Display Settings...]	(P 104)
│ ─ [FAW]	(P 97)	├─ [VF SW]	(P 104)
│ ─ [GAIN L]	(P 97)	├─ [VF Color]	(P 104)
│ ─ [GAIN M]	(P 97)	├─ [VF Bright]	(P 105)
│ ─ [GAIN H]	(P 97)	├─ [VF Contrast]	(P 105)
│ ─ [Dynamic Zoom]	(P 97)	├─ [LCD Bright]	(P 105)
│ ─ [Handle Zoom Speed L]	(P 97)	├─ [LCD Contrast]	(P 105)
│ ─ [Handle Zoom Speed M]	(P 97)	├─ [LCD Backlight]	(P 105)
│ ─ [Handle Zoom Speed H]	(P 97)	├─ [LCD Mirror]	(P 105)
│ ─ [Zoom Ring]	(P 97)	└─ [LCD/VF Peaking]	(P 105)
│ ─ [Iris Dial]	(P 97)	[A/V Set...]	(P 109)
│ ─ [AF Speed]	(P 97)	├─ [Video Set...]	(P 109)
│ ─ [AF Assist]	(P 97)	└─ [Audio Set...]	(P 109)
│ ─ [User Switch Set...]	(P 97)	[System...]	(P 113)
├─ [Camera Process...]	(P 100)	├─ [Record Set...]	(P 113)
│ ─ [Detail]	(P 100)	├─ [Media]	(P 113)
│ ─ [Adjust...]	(P 100)	├─ [Setup File]	(P 113)
├─ [Master Black]	(P 100)	├─ [Tally Lamp]	(P 113)
├─ [Black Toe]	(P 100)	├─ [Language]	(P 113)
├─ [Knee]	(P 100)	├─ [Network] 200	(P 113)
├─ [White Clip]	(P 101)	│ ─ [Settings]	(P 114)
├─ [Gamma]	(P 101)	├─ [Reset All]	(P 114)
├─ [WDR]	(P 101)	├─ [Date/Time]	(P 114)
└─ [White Balance...]	(P 101)	├─ [Time Zone]	(P 114)
		└─ [System Information]	(P 114)

Memo :

- Some menus cannot be set depending on the operating mode or status of the camera recorder. These items are displayed in gray, and they cannot be selected.
- Setting value with the ● mark is the factory default.

Camera Function Menu

Menu screen for specifying operation settings during shooting.

This item can only be selected in the Camera mode.

Bars

For setting whether to output color bars.

[Setting Values: On, ●Off]

Memo : _____

- The audio test signals (1 kHz) can be output simultaneously with the color bar output. (P112 [Test Tone])

OIS

For setting whether to enable image stabilizer. When “On” is selected, set the Level.

[Setting Values: ●On, Off]

↳ Level

For setting the level of the image stabilizer.

[Setting Values: High, ●Normal]

Memo : _____

- The icon changes according to the level set. (P128 [Image Stabilizer Mark])
- When “High” is selected, correcting severe camera shake may cause the area surrounding the image to darken.

Flicker Correction

For setting whether to adjust image flicker that occurs under a fluorescent light.

[Setting Values: On, ●Off]

Shutter

For specifying shutter-related settings.

Set to “Step” (fixed value) or “Variable” when operating with the ▲ / ▼ volume buttons on the side of the camera recorder.

- Variable:
Sets to variable scan. Use this setting when shooting a PC monitor.
- Step:
Sets to step shutter, which switches the shutter speed by a fixed value.

[Setting Values: Variable, ●Step]

AE Speed

For setting the convergence speed during AE (Auto Exposure).

[Setting Values: ●Fast, Middle, Slow]

AGC Limit

For setting the maximum gain value of “AGC”, which electrically boosts the sensitivity level according to the brightness automatically.

[Setting Values: 24dB, ●18dB, 12dB, 6dB]

Auto Iris Limit (OPEN)

For setting the limit value of the OPEN end when auto iris is enabled.

[Setting Values: F4, F2.8, ●F2, F1.8, F1.6, F1.4, F1.2]

Auto Iris Limit (CLOSE)

For setting the limit value of the CLOSE end when auto iris is enabled.

[Setting Values: F11, F8, ●F5.6, F4]

EELimit

For setting the shutter speed control range when the Automatic Shutter mode (EE) is enabled.

[Setting Values: 4F-stop, ●3F-stop, 2F-stop]

Smooth Trans

For setting the shock reduction function, which slows down the sudden change when switching with the [GAIN] or [WHT.BAL B/A/PRST] switch.

[Setting Values: ●Off, Slow, Middle, Fast]

Memo : _____

- This function is disabled when AGC is operating.

FAW

For setting the position in the white balance switch [WHT.BAL B/A/PRST] to assign the FAW (Full Auto White Balance) function.
[Setting Values: ●None, PRST, A, B]

GAIN L/GAIN M/GAIN H

For setting the gain value of each position on the [GAIN] selection switch.
The setting is fixed at "AGC" in the Full Auto mode.
In addition, the sensitivity setting in Lolux is used.
(☞ P98 [Lolux])
[Setting Values: 24dB, 21dB, 18dB, 15dB, 12dB, 9dB, 6dB, 3dB, 0dB, AGC]
(Default values GAIN L: 0dB, GAIN M: 6dB, GAIN H: 12dB)

Dynamic Zoom

For setting whether to enable the dynamic zoom function.

- Off:
Enables only the optical zoom (1x to 12x).
- On:
Enables the dynamic zoom (12x to 24x) in addition to the optical zoom.

[Setting Values: ●Off, On]

Memo : _____
• When [System] is set to "4K", this item is fixed at "Off" and cannot be selected.

Handle Zoom Speed L/Handle Zoom Speed M/Handle Zoom Speed H HDL

For setting the zoom speed for each position on the [ZOOM L/M/H] zoom speed selection switch.
The larger the value the faster the zoom speed.
Selecting "Off" disables the zoom operation on the handle.
[Setting Values: Off, 1 to 7]
(Default Values Handle Zoom Speed L: 1, Handle Zoom Speed M: 4, Handle Zoom Speed H: 7)

Zoom Ring

For assigning the zoom or iris adjustment to the zoom ring.
[Setting Values: ●Zoom, Iris]

Iris Dial

For assigning the iris, shutter or AE level adjustment to the iris dial.
[Setting Values: ●Iris, Shutter, AE Level]

AF Speed

For setting the AF operation speed.
[Setting Values: Fast, ●Middle, Slow]

AF Assist

For setting whether to shift the auto focus point when the focus ring is turned during Auto Focus (AF).

- Off:
Sets the AF Assist function to "Off".
- Far/Near:
This option allows you to shift the auto focus point to near and far directions by turning the focus ring during AF.
- Area:
This option allows you to shift the auto focus point to the left, center, right, or near and far directions by turning the focus ring during AF. Selecting this option displays the  icon in the area.

[Setting Values: ●Off, Far/Near, Area]
(☞ P51 [AF Assist Function])

Memo : _____
• This setting is effective only when the [FOCUS] switch is set to "AUTO".
• The manual focus adjustment mode is temporarily activated by turning the focus ring in the AF mode. If the focus ring is not operated for a certain time, the camera recorder returns to the AF mode.

User Switch Set...

For specifying user button related settings.
(☞ P98 [User Switch Set Item])

User Switch Set Item

USER1 ~ USER9, LCD KEY▲/LCD KEY▶/LCD KEY▼/LCD KEY◀

By assigning one of the following functions to each of the [F.ASSIST/1], [TC/2], [LOLUX/3], [C.REVIEW/4], [ZEBRA/5], [OIS/6], [REC/7], [EXPANDED FOCUS/8], [AWB/9] buttons or the cross-shaped buttons on the LCD monitor, these buttons can be used to control the assigned function (on/off, start, switch).

Set according to the shooting conditions. Usable only in the Camera mode.

[Setting Values: None, Zebra, Marker, Bars, Focus Assist, OIS, LCD Backlight, Lolux, AE/FAW Lock, Face Detect, OK Mark, Clip Cutter Trig, Backup Trig, Clip Review, Load Picture File, White Balance, TC Preset, AWB, Rec, Preset Zoom1, Preset Zoom2, Preset Zoom3, Push AF/AF Lock, One Push Iris, Expanded Focus, Live Streaming **200**]

Memo : _____

- “Rec” can only be assigned to the [REC/7], [EXPANDED FOCUS/8] and [AWB/9] buttons.

Lolux

To increase the sensitivity when in dim surroundings, set a value in the Lolux mode.

[Setting Values: 36dB, ●30dB]

Clip Review

For specifying the operation when any of the [USER1]-[USER9], [LCD KEY▲], [LCD KEY▶], [LCD KEY▼], or [LCD KEY◀] items is set to “Clip Review”.

- Last 5sec:
Views about 5 seconds of the clip from the ending.
- Top 5sec:
Views about 5 seconds of the clip from the beginning.
- Clip:
Views the entire clip.

[Setting Values: ●Last 5sec, Top 5sec, Clip]

Face Detect

For specifying the operation when any of the [USER1]-[USER9], [LCD KEY▲], [LCD KEY▶], [LCD KEY▼], or [LCD KEY◀] items is set to “Face Detect”.

Select the control to track results of face detection.

- AF&AE:
Sets auto focus and exposure control for the face that is being tracked.
- AF:
Sets auto focus for the face that is being tracked.

[Setting Values: ●AF&AE, AF]

(P53 [Adjusting the Focusing by Face Detection])

Memo : _____

- Face detection does not function when the “MF” mode is enabled using the [AF/MF] selection button.
- When “AF” is specified, this function will be activated only when the “AF” mode is enabled using the [AF/MF] selection button.
- When “AF&AE” is specified, this function will operate when the “AF” mode is enabled using the [AF/MF] selection button, and when one or more of the items (Gain, Iris and Shutter) is set to Auto mode.

↳ Sensitivity

For setting the level of ease of face detection.

[Setting Values: Low, Middle, ●High]

↳ Hysteresis

For setting the margin to maintain status when the face that is being tracked is lost.

Set to “Fast” to select another object immediately if the face on the screen is lost.

Set to “Slow” to operate at the same position for some time even if the face on the screen is lost.

[Setting Values: Fast, ●Middle, Slow]

AE/FAW Lock

For specifying the operation when any of the [USER1]-[USER9], [LCD KEY▲], [LCD KEY▶], [LCD KEY▼], or [LCD KEY◀] items is set to “AE/FAW Lock”.

- **FAW:**
Fixes the FAW (Full-time Auto White Balance) setting to the value at the point the user button assigned with “AE/FAW Lock” is pressed.
- **AE:**
Use this feature to fix a value to the Auto function of Gain, Iris, or Shutter when the user button that is assigned “AE/FAW Lock” is pressed.
- **AE/FAW:**
Use this feature to fix the setting for the FAW (Full-time Auto White Balance) and the Auto function of Gain, Iris, or Shutter to the value at the point the user button assigned with “AE/FAW Lock” is pressed.

[Setting Values: FAW, ●AE, AE/FAW]

Memo : _____

- This feature only works when Iris, Shutter, Gain or White Balance is set to Auto mode.
- “AE/FAW Lock” is canceled when the user button assigned with “AE/FAW Lock” is pressed, or when any of the functions that can be locked is operated regardless of the mode (Manual or Auto).

Preset Zoom Speed

For setting the speed to shift to the preset zoom position that is assigned to a user button.

[Setting Values: 1 to 21 (● 11)]

Expanded Focus

For specifying the operation when any of the [USER1]-[USER9], [LCD KEY▲], [LCD KEY▶], [LCD KEY▼], or [LCD KEY◀] items is set to “Expanded Focus”.

- **Toggle:**
Pressing the user button assigned with “Expanded Focus” each time switches the “Expanded Focus” function to on or off.
- **Momentary:**
The “Expanded Focus” function is enabled during the interval while the user button assigned with “Expanded Focus” is pressed.
- **Limited Time:**
Activates the timer.
During autofocus, the [Expanded Focus] feature turns off about 3 seconds after it is turned on. During manual focus, the [Expanded Focus] feature turns off about 3 seconds after you stop operating the focus ring.

[Setting Values: ●Toggle, Momentary, Limited Time]

Camera Process Menu

Menu screen for adjusting the quality of camera images.

This item cannot be selected in the Media mode.

Detail

For adjusting the contour (detail) enhancement level.

Increasing the value increases the sharpness of the contour.

[Setting Values: -10 to +10, Off (●0)]

↳ Adjust...

For specifying the detailed settings of the contour (detail).

(P102 [Detail/Adjust Item])

Memo : _____

- This item cannot be selected when [Detail] is set to "Off".

Master Black

For adjusting the pedestal level (master black) that serves as the reference black.

Increasing the value increases the pedestal.

[Setting Values: -50 to +50 (●0)]

Black Toe

Process the dark areas according to the balance of bright and dark areas in the image to adjust the overall balance of contrast.

For altering the gain of dark areas. Adjust this item according to the condition of the captured video signals.

- Stretch:
Increases the gain of dark areas in an image to stretch the signals of these areas only, thereby showing the contrast between bright and dark areas more clearly.
Specify the amount of stretch with [Stretch Level].
- Normal:
Normal condition.
- Compress:
Compresses the gain of dark areas to increase the contrast when the entire image appears bright and contrast is weak. Specify the compression amount with [Compress Level].

[Setting Values: Stretch, ●Normal, Compress]

Memo : _____

- When [WDR] is set to other than "Off", this item appears as "---" and cannot be selected.

↳ Stretch Level

Stretch amount increases when a larger value is specified.

[Setting Values: 1 to 5 (●3)]

Memo : _____

- This item is displayed only when [Black Toe] is set to "Stretch". Otherwise, this item appears as "---" and cannot be selected.

↳ Compress Level

Compression amount increases when a larger value is specified.

[Setting Values: 1 to 5 (●3)]

Memo : _____

- This item is displayed only when [Black Toe] is set to "Compress". Otherwise, this item appears as "---" and cannot be selected.

Knee

For specifying the "Knee" operation, which compresses video signals beyond a certain level to show the gradation of the highlighted portion. To check the gradation of a bright area, set to "Manual" and adjust the knee point (starting point of knee operation) manually.

- Manual:
Enables manual adjustment of knee point using [Level].
- Auto:
Adjusts the knee point automatically according to the luminance level.

[Setting Values: Manual, ●Auto]

Memo : _____

- When [WDR] is set to other than "Off", this item appears as "---" and cannot be selected.

↳ Level

For setting the starting point (knee point) of knee compression when [Knee] is set to "Manual".

[Setting Values: ●100.0%, 97.5%, 95.0%, 92.5%, 90.0%, 87.5%, 85.0%]

Memo : _____

- When [Knee] is set to other than "Auto", or [WDR] is set to other than "Off", this item appears as "---" and cannot be selected.

↳ Sensitivity

For setting the response speed of the “Knee” operation when [Knee] is set to “Auto”. Set to “Slow” when shooting an object under a condition where there is drastic change in the light intensity.

[Setting Values: ●Fast, Middle, Slow]

Memo : _____

- When [Knee] is set to “Manual”, or [WDR] is set to other than “Off”, this item appears as “---” and cannot be selected.

White Clip

For setting the point to apply white clip for input video signals with a high luminance level.

- 108%:
Applies white clip at the point where the luminance level is 108 %.
- 103%:
Applies white clip at the point where the luminance level is 103 %.
- 100%:
Applies white clip at the point where the luminance level is 100 %. Set to this value when the system in use limits Y output signals within 100 %.

[Setting Values: ●108%, 103%, 100%]

Memo : _____

- When [WDR] is set to other than “Off”, this item appears as “108%” and cannot be selected.

Gamma

For adjusting the gamma curve that determines the gradation expression.

- Cinema:
Sets to a gamma curve with similar gradation to the screen characteristics of movies.
- Standard:
Sets to a standard gamma curve.

[Setting Values: Cinema, ●Standard]

Memo : _____

- When [WDR] is set to other than “Off”, this item appears as “---” and cannot be selected.

↳ Gamma Level

This item can be specified separately when [Gamma] is set to “Standard” or “Cinema”.

- Increase the number:
Enhances the gradation of black. However, the gradation of bright areas deteriorates.
- Decrease the number:
Enhances the gradation of bright areas. However, the gradation of black deteriorates.

[Setting Values: -5 to +5 (● 0)]

WDR

For setting the WDR (Wide Dynamic Range) function.

When shooting object with wide dynamic range due to backlight conditions, this function compresses the dynamic range while maintaining image contrast through providing gradation compensation to the input video signals.

- Strong:
Enhances the effect of gradation compensation for object with wide dynamic range due to outdoor or strong backlight conditions.
- Natural:
Normal setting for wide dynamic range.
- Weak:
Reduces the effect of gradation compensation compared to the normal setting.
- Off:
Sets the wide dynamic range function to “Off”.

[Setting Values: Strong, Natural, Weak, ●Off]

Memo : _____

- When [WDR] is set to other than “Off”, [Black Toe], [Knee], [Gamma] and [White Clip] cannot be selected.

White Balance...

Menu for adjusting white balance.
(☞ P102 [White Balance Item])

- * For details, refer to “[Adjusting the White Balance]” (☞ P 60).

Color Matrix

For setting the color matrix.

- **Cinema Subdued:**
Sets to a subdued color matrix that is similar to the screen characteristics of movies.
- **Cinema Vivid:**
Sets to a vivid color matrix that is similar to the screen characteristics of movies.
- **Standard:**
Sets to a standard color matrix.

[Setting Values: Cinema Subdued, Cinema Vivid, ●Standard]

Color Gain

For adjusting the video signal color level.

Increasing the value deepens the color.

[Setting Values: -50 to +15, Off (●0)]

Memo : _____

- Images are displayed in black-and-white when this is set to "Off".

Reset Process

Restores all items in the [Camera Process] menu to their default settings.

Detail/Adjust Item**V/H Balance**

For setting the H/V balance to enhance contour (detail) in the horizontal (H) or vertical (V) direction.

- **H+1 to H+4:**
Increasing the value enhances contour in the horizontal direction.
- **V+1 to V+4:**
Increasing the value enhances contour in the vertical direction.

[Setting Values: H+1 to H+4, ●Normal, V+1 to V+4]

Memo : _____

- When [System] under [Record Format] is set to "SD", this item is fixed at "Normal".
- When [System] under [Record Format] is set to "HD+Web", this item can be set during HD recording, but will be fixed at "Normal" during SD recording.

White Balance Item**Preset Temp.**

For setting the color temperature when the [WHT.BAL B/A/PRST] switch is set to "PRST".

For details, refer to "[Adjusting the White Balance] (P 60)".

Alternative Temp.

For setting the alternative color temperature in the Preset mode.

When the [WHT.BAL B/A/PRST] switch is set to "PRST", pressing the [AWB/9] button each time switches the color temperature setting in the Preset mode. ([Preset Temp.] ↔ [Alternative Temp.]

For details, refer to "[Adjusting the White Balance] (P 60)".

AWB Paint

For adjusting the R (red)/B (blue) component in the AWB (Auto White Balance) mode. For details, refer to “[Adjusting the White Balance] (P 60)”.

- Increase the number:
Strengthens the red/blue.
- Decrease the number:
Weakens the red/blue.

[Setting Values: -32 to +32 (● 0)]

Memo : _____

- This item is selectable when the [WHT.BAL B/A/PRST] switch on the right of the camera recorder is set to “A” or “B”. When “PRST” is set, this item appears as “---” and cannot be selected.
- Different values can be specified for “A” and “B”.
- When [Clear Paint After AWB] is set to “On”, pressing the [AWB/9] button to readjust the white balance switches the R and B values automatically to “0”.

Clear Paint After AWB

For specifying whether to clear the [AWB Paint] (R value and B value) settings after executing AWB (Auto White Balance).

- On:
Sets the [AWB Paint] (R value and B value) settings to “0” after executing AWB (Auto White Balance).
- Off:
Does not change the [AWB Paint] (R value and B value) settings after executing AWB (Auto White Balance).

[Setting Values: ●On, Off]

FAW Paint

For adjusting the R (red)/B (blue) component during FAW (Full Auto White Balance) mode.

- Increase the number:
Strengthens the red/blue.
- Decrease the number:
Weakens the red/blue.

[Setting Values: -32 to +32 (● 0)]

TC/UB Menu

Menu screen for setting time code and user’s bit. This item cannot be selected in the Media mode, or during recording.

TC Generator

For setting the operation of the time code.

- Free Run:
The time code operates in the run mode at all times regardless of the recording status. It continues to run even when the power of the camera recorder is turned off.
- Rec Run:
The time code operates in the run mode during recording. It continues to run in the order of the recorded clips as long as the SD card is not replaced. If the SD card is removed and recording is made on another card, time code will be recorded on the new card from where it was left off in the previous card.
- Regen:
The time code operates in the run mode during recording. When the SD card is replaced, the last time code recorded on the card is read and recorded on a new card so that the time code continues in running order.

[Setting Values: Free Run, ●Rec Run, Regen]

TC Preset

For setting the time code (hour, minute, second, frame).

Display : Drop setting 02:02:25.20
: Non Drop setting 02:02:25:20

UB Mode

For setting the recording mode of the user’s bit.

- Date:
Records the date.
- Time:
Records the time.
- Preset:
Records according to the preset setting.
(P71 [Setting the User’s Bit])

[Setting Values: Date, Time, ●Preset]

Memo : _____

- If UB Mode is set to “Time”, the user’s bit operates in the 24-hour format even if the LCD display is in the 12-hour format.

↳ Preset

For setting the user's bit. (Digit by digit)

Display : AB CD EF 01

(P71 [Presetting the User's Bit])

Memo : _____

- When [UB Mode] is set to "Date" or "Time", this item appears as "---" and preset is disabled.

Drop Frame

For setting the framing mode of the time code generator.

- Non Drop:
Internal time code generator works in the non-drop-frame mode. Use this setting when placing emphasis on the number of frames.
- Drop:
Internal time code generator works in the drop-frame mode. Use this setting when placing emphasis on the recording time.

[Setting Values: Non Drop, ●Drop]

Memo : _____

- This item can be set only when [Main Menu] → [System] → [Record Set] → [Record Format] → [A]Frame Rate is set to "60p", "30p", or "60i". When [Frame Rate] is "24p", "Non Drop" becomes fixed and cannot be selected. When [Frame Rate] is "50p", "25p", or "50i", this item appears as "---" and cannot be selected. (P115 [Frame Rate])

LCD/VF Menu

Item for specifying settings related to the LCD monitor or viewfinder screen.

This menu screen can be used to specify settings related to the Focus Assist mode, zebra pattern display, screen size, marker, and safety zone. In addition, it is also used for selecting whether to display characters on the LCD monitor or viewfinder screen, as well as for adjusting the picture quality of the LCD monitor.

Shooting Assist...

Menu for setting the Shooting Assist function.

(P105 [Shooting Assist Item])

Marker Settings...

For setting items such as the safety zone and center mark.

(P106 [Marker Settings Item])

Display Settings...

For specifying display-related settings.

(P107 [Display Settings Item])

VF SW

For setting whether to assign the operation for pulling out or retracting the viewfinder to the switch.

- Disable:
A viewfinder image is displayed regardless of the state of the viewfinder.
- Enable:
Displays a viewfinder image only when the viewfinder is pulled out.

[Setting Values: Disable, ●Enable]

Memo : _____

- Displays a viewfinder image regardless of the setting when an image is not displayed on the LCD monitor. (P37 [Displays on the LCD Monitor and Viewfinder Screen (VF)])

VF Color

For selecting whether to display the image on the viewfinder screen in color or black-and-white. Select "On" to display in color, and "Off" to display in black-and-white.

[Setting Values: ●On, Off]

VF Bright

For setting the brightness of the viewfinder screen. Increasing the value increases the brightness. [Setting Values: -10 to +10 (● 0)]

VF Contrast

For setting the difference in luminance between the darkest and brightness areas in the viewfinder screen. Increasing the value increases the contrast. [Setting Values: -10 to +10 (● 0)]

LCD Bright

For setting the brightness of the LCD screen. Increasing the value increases the brightness. [Setting Values: -10 to +10 (● 0)]

LCD Contrast

For setting the difference in luminance between the darkest and brightness areas in the LCD monitor. Increasing the value increases the contrast. [Setting Values: -10 to +10 (● 0)]

LCD Backlight

For setting the brightness of the LCD monitor backlight. [Setting Values: Bright, ●Normal]

LCD Mirror

For specifying the image display method when facing the LCD monitor. Select "Mirror" to display the image after laterally inverting it. (Mirror display)
( P37 [Adjusting the LCD Monitor and Viewfinder])
[Setting Values: Mirror, ●Normal]

Memo : _____

- The setting of this item is valid only in Camera mode.
- During color bar, expanded focus, menu screen and status screen display, the "Mirror" setting is disabled.
( P135 [Color Bar Output])

LCD/VF Peaking

For adjusting the contour of the image displayed on the LCD monitor and viewfinder. [Setting Values: -10 to +10 (● 0)]

Shooting Assist Item**Focus Assist**

For setting whether to add color to the contour of the focused image upon switching the image to black-and-white. [Setting Values: On, ●Off]

↳ **Type**

For specifying the operation when the [F.ASSIST/1] button is pressed.

( P52 [Focus Assist Function])

- **ACCU-Focus:**
Enables the Focus Assist and ACCU-Focus (forced focus) functions. The depth of field of the object becomes shallower to enable easier focusing. The ACCU-Focus function switches automatically to "Off" after about 10 seconds.
- **Normal:**
Enables only the Focus Assist function. The focused area is displayed in color to enable easier focusing. Display color can be specified with [Color].

[Setting Values: ACCU-Focus, ●Normal]

↳ **Color**

For setting the display color of the focused area when Focus Assist is activated. [Setting Values: ●Blue, Green, Red]

Zebra

For selecting whether to display zebra patterns at the bright areas of the subject. Select "On" to display zebra patterns or "Off" to hide. [Setting Values: On, ●Off]

↳ **Top**

For setting the maximum luminance level for the zebra pattern display. [Setting Values: Over, 100% to 5% (in 5% increments)] (●80%)

↳ **Bottom**

For setting the minimum luminance level for the zebra pattern display. [Setting Values: 100% to 0% (in 5% increments)] (●70%)

Memo : _____

- The relation between Top and Bottom is such that Top>Bottom always holds. To maintain this relation during setting, the setting value is automatically corrected.

Marker Settings Item

For setting the marker and safety zone, which are useful in helping you determine the angle of view for the image according to the shooting purpose.

(P135 [Marker and Safety Zone Displays (Camera Mode Only)])

Memo : _____

- During Clip Review or when in the Media mode, the markers do not appear regardless of the setting.

Marker

For setting whether to display marker, safety zone, and center marks on the screen.

[Setting Values: On, Off]

↳ Grid Marker

For setting whether to display a 3x3 grid on the screen.

[Setting Values: On, Off]

Memo : _____

- When [Grid Marker] is set to "On", [Aspect Ratio], [Aspect Marker], and [Safety Zone] do not function.

↳ Aspect Ratio

For selecting the final image aspect ratio to be used from the overall angle of view.

[Setting Values: 16:9(+4:3), 2.35:1 Top, 2.35:1 Center, 1.85:1 Top, 1.85:1 Center, 16:9, 1.75:1, 1.66:1, 14:9, 13:9, 4:3]

Memo : _____

- When [System] → [Record Set] → [Record Format] → [SD Aspect] is set to "4:3", this item is fixed at "4:3" and cannot be selected.
(P116 [SD Aspect])

↳ Aspect Marker

For specifying how boundary markers are to be used to indicate the parts of an image that are beyond the range of the aspect ratio selected in [Aspect Ratio].

- Line+Halftone:
Displays the boundary using lines, and areas outside the boundary in halftone.
- Halftone:
Displays areas outside the boundary in halftone.
- Line:
Displays the boundary using lines.
- Off:
Hides the boundary markers.

[Setting Values: Line+Halftone, Halftone, Line, Off]

Memo : _____

- When [Aspect Ratio] is set to "16:9" or "16:9(+4:3)", this item is fixed at "Off" and cannot be selected.

↳ Safety Zone

For setting the percentage of area that is to be deemed as valid area (Safety Zone) within the boundary of the aspect ratio selected in [Aspect Ratio].

[Setting Values: 95%, 93%, 90%, 88%, 80%, Off]

↳ Center Mark

For specifying whether to display a mark to indicate the screen center within the aspect ratio selected in [Aspect Ratio].

[Setting Values: On, Off]

Display Settings Item

This menu is used to set the displays on the LCD monitor and viewfinder screen.

Zoom

For setting the display method of the zoom position.

- Number:
Displays the zoom position in numbers (0-99).
- Bar:
Displays the zoom position in a bar.
- Off:
Does not display the zoom position.

[Setting Values: Number, ●Bar, Off]

Focus

For setting the display method of the focal length during manual focus.

- Feet:
Displays the focal length in feet.
- Meter:
Displays the focal length in meters.
- Off:
Hides the focal length.

[Setting Values: Feet, ●Meter, Off]

WB Indicator

When “On” is selected and WB is set manually, the difference in value with the Auto WB (recommended) is displayed as an icon on the screen.

(Example) When 3200K is selected

<●3200K>

..... Color temperature setting is appropriate

<▲3200K> Color temperature setting is higher

<▼3200K> Color temperature setting is lower

[Setting Values: ●On, Off]

ND Filter

For setting whether to display the filter position.

- Off:
Hides the filter position.
- On:
Displays the current filter position.
- On+Assist:
Displays the current filter position.
If the ND filter setting is inappropriate, the appropriate ND filter to select will appear blinking.

[Setting Values: Off, ●On, On+Assist]

Record Format

For setting whether to display the video format during recording or playback.

[Setting Values: ●On, Off]

Media Remain

For setting whether to display the remaining space of the recording SD card.

[Setting Values: ●On, Off]

Memo : _____

- When the remaining space warning is displayed, the information appears even when “Off” is selected.
- The displayed time is an estimate.

TC/UB

For specifying whether to display the time code (TC) or user’s bit (UB) rate in the display on the LCD monitor and viewfinder screen.

[Setting Values: UB, ●TC, Off]

Audio Meter

For specifying whether to display the audio level meter on the LCD monitor and viewfinder screen.

[Setting Values: ●On, Off]

Battery

For setting the display of the remaining battery power in the display on the LCD monitor and viewfinder screen.

The battery information appears only on the Display 1 screen in Camera mode.









( P127 [Display 1 screen])

- Time:
Displays the remaining battery power in minutes. (min)
- Capacity%:
Displays the remaining battery power in percentage. (%)
- Voltage:
Displays the current battery voltage in units of 0.1 V. (V)
- Off:
The remaining battery power is not displayed.

[Setting Values: ●Time, Capacity%, Voltage, Off]

Memo : _____

- The battery mark that appears before the “Time”, “Capacity%” or “Voltage” value changes according to the remaining battery power. In addition, the plug mark is added during charging.

		: 10 % and below
		: 11 % to 30 %
		: 31 % to 70 %
		: 71 % to 100 %

- When the remaining battery power is low, “RES” instead of the value is displayed. Replace the battery as soon as possible.
- The remaining battery power and remaining time are intended as reference values for the shooting duration.
- The time, capacity or voltage will not be displayed during charging.

Date/Time

For specifying whether to display the date and time in the display on the LCD monitor and viewfinder screen.

[Setting Values: ●On, Off]

Date Style

For setting the date display sequence for display on the LCD monitor and viewfinder screen as well as for time stamp recording.

Display examples of the setting values are as follows.

- DMY2: 30 Jun 2012
- DMY1: 30-06-2012
- MDY2: Jun 30, 2012
- MDY1: 06-30-2012
- YMD: 2012-06-30

[Setting Values: DMY2, DMY1, MDY1, MDY2, YMD]

(Default values: MDY2 (U model), DMY1 (E model))

Time Style

For setting the time display for display on the LCD monitor and viewfinder screen as well as for time stamp recording.

[Setting Values: 24hour, 12hour]

(Default values: 12hour (U model), 24hour (E model))

Shutter

For setting the shutter display to be displayed on the LCD monitor and viewfinder screen.

- DEG: Displays the shutter speed in degrees in the same way as film cameras.
- SEC: Displays the shutter speed in seconds.

[Setting Values: DEG, ●SEC]

Memo : _____

- “DEG” is selectable only when [A]Frame Rate is set to “24p” or “25p”. When [A]Frame Rate is set to other values, the shutter display setting is fixed at “SEC” and cannot be selected. (P115 [A]Frame Rate)

A/V Set Menu

Menu screen for video output and audio.

Video Set...

For specifying video output-related settings.
(P109 [Video Set Item])

Audio Set...

For specifying audio-related settings.
(P110 [Audio Set Item])

Video Set Item

Display On TV

For setting whether to display the display and menu characters on the external monitor.
[Setting Values: On, ●Off]

HDMI/SDI Out 200

For setting the terminal to output the video.
[Setting Values: HDMI+SDI, SDI, HDMI, ●Off]

↳ Resolution 200

For selecting the resolution of video output from the [HDMI] terminal or [SDI OUT] terminal according to the monitor to be connected.

[Setting Values: 576i, 576p, 480i, 480p, 720p, 1080i, 1080p, 2160/24p, 2160/25p, 2160/30p]

Memo : _____

- The selectable options vary according to the setting in [System]/[A]Resolution] and [A]Frame Rate] of [System] → [Record Set] → [Record Format].
- Cross conversion output is not possible.
- This item cannot be specified when HDMI/SDI Out is set to "Off".

↳ HDMI Color 200

- For setting the color format of HDMI signals.
- This item is selectable when [HDMI/SDI Out] is set to "HDMI" or "HDMI+SDI".

[Setting Values: RGB, ●Auto]

↳ HDMI Enhance 200

- For setting the color range of HDMI signals. When connecting to a PC monitor, set this to "On".
- This item is selectable when [HDMI/SDI Out] is set to "HDMI" or "HDMI+SDI".

[Setting Values: On, ●Off]

↳ SDI Rec Trigger 200

For setting whether to superimpose trigger signals in tandem with the [SDI OUT] terminal as well as the [REC] button on the camera body.

If "On" is specified, it is possible to record on a device equipped with SDI record trigger in tandem with the operation of the [REC] button.

When a compatible device is connected, recording/stop control signals are output in tandem with the operation of the [REC] button.

The SDI record trigger output status to the connected device is indicated by REC →/STBY → on the display screen.

[Setting Values: On, ●Off]

Memo : _____

- Even if REC →/STBY → is displayed on the display screen, the compatible device may not necessarily be recording.

HDMI Out 170

For setting whether to output the HDMI signal.
[Setting Values: On, ●Off]

↳ Resolution 170

For selecting the resolution of video output from the [HDMI] terminal according to the monitor to be connected.

[Setting Values: 576i, 576p, 480i, 480p, 720p, 1080i, 1080p, 2160/24p, 2160/25p, 2160/30p]

Memo : _____

- The selectable options vary according to the setting in [System]/[A]Resolution] and [A]Frame Rate] of [System] → [Record Set] → [Record Format].
- Cross conversion output is not possible.

↳ HDMI Color 170

- For setting the color format of HDMI signals.
- This item is selectable when [HDMI Out] is set to "On".

[Setting Values: RGB, ●Auto]

↳ HDMI Enhance 170

- For setting the color range of HDMI signals. When connecting to a PC monitor, set this to "On".
- This item is selectable when [HDMI Out] is set to "On".

[Setting Values: On, ●Off]

SD Aspect

For setting the style of displaying images with a 16:9 aspect ratio on a 4:3 aspect ratio screen.

- Letter:
Displays as a wide image with the top and bottom blackened.
- Squeeze:
Displays image that is squeezed horizontally.

[Setting Values: Letter, ●Squeeze]

Memo : _____

- When [Record Format] → [System] is set to "SD", and [Record Format] → [SD Aspect] is set to "4:3", "---" is displayed and selection is disabled.

(P115 [System])

SD Set Up

For selecting whether to add a setup signal to the video signal output from the [AV] output terminal. Setup signals are added when "7.5%" is selected.

[Setting Values: 7.5%, 0.0%]

(Default values: 7.5% (U model), fixed at "0.0%" (E model))

Memo : _____

- Depending on the menu settings of the camera recorder and the condition of the cable connected to it, the setup signal setting may be fixed at "0.0%". "0.0%" is displayed in gray in this case.

Audio Set Item

CH1 INT

For selecting either the built-in microphone or the [AUX] terminal as the CH1 audio input signal.

This item is selectable if the [CH1] audio input signal selection switch is set to "INT" **HDL**, and a microphone is connected to the [AUX] terminal.

- AUX L:
Sets the [AUX] terminal as the CH1 audio input signal.
- Int. Mic L:
Sets the left channel (Lch) of the built-in microphone as the CH1 audio input signal.

[Setting Values: ●AUX L, Int. Mic L]

Memo : _____

- If the [AUX] terminal is not connected, this item is fixed at "Int. Mic L".
- When the [CH1] audio input signal selection switch is set to a value other than "INT", "---" is displayed and selection is disabled.
- If the handle unit is not connected, the state of the [CH1] audio input signal selection switch is equivalent to "INT".

CH2 INT

For selecting either the built-in microphone or the [AUX] terminal as the CH2 audio input signal.

This item is selectable if the [CH2] audio input signal selection switch is set to "INT" **HDL**, and a microphone is connected to the [AUX] terminal.

- AUX R:
Sets the [AUX] terminal as the CH2 audio input signal.
- Int. Mic R:
Sets the right channel (Rch) of the built-in microphone as the CH2 audio input signal.

[Setting Values: ●AUX R, Int. Mic R]

Memo : _____

- If the [AUX] terminal is not connected, this item is fixed at "Int. Mic R".
- When the [CH2] audio input signal selection switch is set to a value other than "INT", "---" is displayed and selection is disabled.
- If the handle unit is not connected, the state of the [CH2] audio input signal selection switch is equivalent to "INT".

Input1 Mic Ref./Input2 Mic Ref. **HDL**

For setting the reference input level when the [INPUT1]/[INPUT2] selection switch is set to "MIC" or "MIC+48V".

[Setting Values: -62dB, -56dB, ●-50dB, -44dB, -38dB, -32dB]

Memo : _____

- This item is not displayed if the handle unit is not connected.

Ref. Level

For setting the recording reference level. (Applies to both [CH1/CH2].)

[Setting Values: -12dB, -18dB, ●-20dB]

XLR Manual Level HDL

For setting whether to link manual audio adjustment operation between [INPUT1] and [INPUT2] terminals.

Select "Link" to link or "Separate" to separate.

When this item is set to "Link", adjust the recording level using the [CH1] recording level adjustment knob.

[Setting Values: Link, ●Separate]

Memo : _____

- This item is not displayed if the handle unit is not connected.
- Enabled only when both the [INPUT1/INPUT2] input terminals are set to "LINE" or "MIC", and both [CH1]/[CH2] of the [CH1/CH2 AUTO/MANUAL] selection switches are set to "MANUAL".
- If any of the [INPUT1/INPUT2] input terminals is set to "INT", and [LEVEL MODE] is set to "AUTO", this item is fixed at "Separate".
- When this item is set to "Link", [CH2] recording level adjustment knob is disabled.

Audio Level

Select this item to switch to the audio level adjustment screen.

( P67 [Setting the Audio recording Level in the Main Menu])

* The contents displayed on the screen vary depending on the various settings.

Memo : _____

- This item is not displayed if the handle unit is connected.
- When [Audio On FULL AUTO] is set to "Auto", this item cannot be selected when Full Auto is enabled using the [FULL AUTO] button.
- If both CH1 and CH2 are set to the built-in microphone or to AUX, settings for CH2 will not be displayed, and the settings for CH1 will apply to CH2.

Limiter Mode

For setting whether to link the limiter operation of [CH1] and [CH2].

Select "Link" to link or "Separate" to separate.

[Setting Values: Link, ●Separate]

Memo : _____

- You can select either "Link" or "Separate" only when the [CH1/CH2] audio input signal selection switch is set to "INPUT1"/"INPUT2" respectively and both the [INPUT1/INPUT2] input signal selection switches are set to the same setting and both the [CH1/CH2 AUTO/MANUAL] selection switches are set to "AUTO".
- This item is fixed at "Link" when [CH1 INT] and [CH2 INT] have the following combinations.
 - "AUX L" and "AUX R"
 - "Int. Mic L" and "Int. Mic R"
- In all other cases, it is fixed at "Separate".

↳ CH1 Limiter/CH2 Limiter

For specifying the limiter settings for the CH1/CH2 audio input.

■ Threshold Level

For setting the value for activating the limiter.

[Setting Values: Off, ●-6dBFS, -9dBFS]

■ Attack Time

For setting the response speed for activating the limiter.

[Setting Values: Slow, ●Middle, Fast]

■ Decay Time

For setting the attenuation rate after the limiter is activated.

[Setting Values: Slow, ●Middle, Fast]

Memo : _____

- When [Limiter Mode] is set to "Link", [CH2 Limiter] cannot be specified.
- If the channel specified is set to "AUTO", [Threshold Level] cannot be set to "Off".

INPUT1 Mic Wind Cut/INPUT2 Mic Wind Cut

HDL

For selecting whether to cut the low frequencies of the audio input signals (low-cut) when the [INPUT1]/[INPUT2] selection switch is set to "MIC" or "MIC+48V".

Set this item to reduce wind noise from the microphone.

[Setting Values: On, ●Off]

Memo : _____

- This item is not displayed if the handle unit is not connected.

Int. Mic Wind Cut

For selecting whether to cut the low frequencies of the audio input signals (low-cut) from the built-in microphone. Set this item to "On" to reduce wind noise from the microphone.

[Setting Values: On, ●Off]

Memo : _____

- This item is enabled in the following cases.
 - When the [CH1] or [CH2] selection switch is set to "INT". **HDL**
 - [CH1 INT] is set to "Int. Mic L" or [CH2 INT] is set to "Int. Mic R".
 - (P110 [CH1 INT])
 - (P110 [CH2 INT])

Int. Mic Stereo Enhancer

For setting the enhancement level of the stereo effect of the built-in microphone.

- On: Enhances the stereo effect.
- Off: Does not enhance the stereo effect.

[Setting Values: On, ●Off]

Memo : _____

- This item is enabled in the following cases.
 - Both [CH1] and [CH2] selection switches are set to "INT". **HDL**
 - [CH1 INT] is set to "Int. Mic L" and [CH2 INT] is set to "Int. Mic R".
 - (P110 [CH1 INT])
 - (P110 [CH2 INT])

Monitor

For setting the audio output from the jack or the speaker.

- CH1: Outputs only the audio input from [CH1].
- CH2: Outputs only the audio input from [CH2].
- Mix: Generates a mixed audio output from [CH1] and [CH2].
- Stereo: Outputs audio from [CH1] to L and audio from [CH2] to R.

[Setting Values: CH1, CH2, Mix, ●Stereo]

Memo : _____

- If both [CH1] and [CH2] are input signals of the built-in microphone, "Mix" cannot be selected for the output from the jack.
- "Stereo" cannot be selected for speaker output.

Alarm Level

For selecting whether to turn on the warning tone as well as setting the volume.

The warning tone is output from the monitor speaker or terminal.

[Setting Values: High, Low, ●Off]

Test Tone

For specifying whether to output the audio test signals (1 kHz) during color bar output.

[Setting Values: On, ●Off]

Audio On FULL AUTO

For setting whether to enable Auto for audio when Full Auto is enabled using the [FULL AUTO] button.

- SW Set: The audio recording mode follows the settings below.
 - When the handle unit is connected: Follows the [CH1 AUTO/MANUAL]/[CH2 AUTO/MANUAL] selection switch setting.
 - When the handle unit is not connected: Follows the MENU setting (AUTO/MANUAL in the audio level setting).
- Auto: Sets audio recording mode to the forced auto mode.

[Setting Values: SW Set, ●Auto]

System Menu

This menu screen allows system-related settings. For specifying recording settings, formatting and restoring of SD card, tally lamp settings, network settings, date/time, time zone, and other settings. It can also be used to reset the menu settings to their default values.

Record Set...

For specifying recorded video-related settings.
(☞ P114 [Record Set Item])

Media

↳ Format Media

For formatting (initializing) an SD card. Select a card slot (A or B), select [Format] from [Cancel]/[Format], and press the Set button (●) to format (initialize) the card.
(☞ P42 [Formatting (Initializing) SD Cards])

↳ Restore Media

For restoring an SD card. Select a card slot (A or B), and press the Set button (●) to restore the SD card.
(☞ P43 [Restoring the SD Card])

Memo : _____

- This item appears only when the SD card needs to be restored. However, it is not selectable when recording in Camera mode and during Clip Review.

Setup File

This allows you to save the menu settings as well as the performance results of shutter speed and AWB. It is useful to save settings according to different shooting conditions.

↳ Load File...

Loads the settings.
(☞ P137 [Loading a Setup File])

↳ Store File...

Saves the settings.
(☞ P136 [Saving Setup Files])

Tally Lamp

For setting whether to light up the tally lamp during recording, when the remaining space warning is displayed, or during live streaming.

Memo : _____

- The blinking warning display, such as when the remaining battery level is low, is enabled in a setting other than "Off".

■ 200

- Off:
Turns off the indicator.
- Rec:
Lights up during recording.
- Live Streaming:
Lights up during live streaming. Does not light up during recording.
- Rec/Live Streaming:
Lights up during recording or live streaming.
[Setting Values: Off, ●Rec, Live Streaming, Rec/Live Streaming]

■ 170

- Off:
Turns off the indicator.
- On:
Lights up during recording.
[Setting Values: Off, ●On]

Language

Switches between languages in the menu screen.
[Setting Values: ●English, Français, Español] (U model)
[Setting Values: ●English, Français, Deutsch, Italiano, Español, Русский, Türkçe] (E model)

Network 200

When using the network feature, set to "On".

- On:
Uses the network function.
- Off:
Does not use the network function.

[Setting Values: On, ●Off]

↳ Import Metadata

- For importing metadata from the FTP server. **200**
- Deletes the metadata loaded using the setup files ("User File"/"All File").

Memo : _____

- This option is not available when [Network] is set to "Off".

↳ Settings...

For specifying network-related settings.
(☞ P118 [Network/Settings Item **200**])

Memo : _____

- This option is not available when [Network] is set to "Off".

Reset All

Resets all menu settings.

Memo : _____

- [Date/Time] and [Time Zone] cannot be reset.
(☞ P114 [Date/Time])
(☞ P114 [Time Zone])
- This item is not selectable when recording in Camera mode, during Clip Review, during live streaming **200** and in Media mode.

Date/Time

For setting the year, month, day, hour, and minute.

Memo : _____

- The display order of the date (year, month, day) follows the setting in [Display Settings] → [Date Style]. However, the 24-hour format is used for the hour display regardless of the [Time Style] setting.
(☞ P108 [Date Style])

Time Zone

For setting the UTC time difference in units of 30 minutes.

[Setting Values: UTC-00:30-UTC-12:00, UTC, UTC+14:00-UTC+00:30 (in 30 min increments)]
(Default values: UTC-05:00 (U model), UTC (E model))

Memo : _____

- If [Date/Time] is already set, the [Date/Time] item is automatically adjusted when [Time Zone] is altered.

System Information

↳ Version

Displays information on the firmware version.
Display example : 0000-0000

↳ Fan Hour

For displaying the usage time of the internal fan.

Memo : _____

- Under normal environment, dust will accumulate on the internal fan when the camera recorder is used over a long period. Dust may enter the camera recorder especially if it is used outdoors. This may affect the image and sound quality of the camera recorder. Check and replace the fan after every 9000 hours (suggested guideline).

↳ Open Source License

Displays the license for the open source software used by this camera recorder.

Record Set Item

Record Format

After setting of all items in the [Record Format] menu is complete, select [Set] at the bottom of the screen to apply the new settings on the camera recorder and switch the recording format. A "Please Wait..." message appears during switching.

↳ System

For selecting a system definition.

- 4K:
Records in “4K” quality for both slots A and B.
- HD:
Records in “HD” (High Definition) quality for both slots A and B.
- SD:
Records in “SD” (Standard Definition) quality for both slots A and B.
- HD+Web:
Records in “HD” (high definition) for slot A, and in resolution suitable for web distribution for slot B.

[Setting Values: 4K, ●HD, SD, HD+Web]

Caution : _____

- The selectable options for the [AFormat], [AResolution], [AFrame Rate], and [ABit Rate] settings vary depending on the setting of this item.

↳ A Format

For selecting the format of the file to be recorded to the SD card in slot A.

- QuickTime:
QuickTime file format (.MOV)
- AVCHD:
AVCHD file format

[Setting Values: ●QuickTime, AVCHD]

Memo : _____

- When [System] is set to “4K”, this item is fixed at “QuickTime”.

↳ A Resolution

For selecting the image size to be recorded to the SD card in slot A. (Horizontal x vertical)

The available options vary according to the [System] and [AFormat] settings.

- When [System] is set to “4K”:
Fixed at “3840x2160”.
- When [System] is set to “HD” or “HD+Web”, and [AFormat] is set to “QuickTime”:
[Setting Values: ●1920x1080, 1280x720]
- When [System] is set to “HD” or “HD+Web”, and [AFormat] is set to “AVCHD”:
Fixed at “1920x1080”.
- When [System] is set to “SD”:
Fixed at either “720x480” or “720x576”.

Memo : _____

- The selectable values of [AFrame Rate] and [ABit Rate] vary according to the setting of this item.

↳ A Frame Rate

For selecting the frame rate to be recorded to the SD card in slot A.

The available options vary according to the settings for [System], [AResolution], and [AFormat].

- When [System] is set to “4K”:
[Setting Values: 30p, 25p, 24p]
- When [System] is set to “HD” or “HD+Web”:
 - When [AResolution] is set to “1920x1080” ([AFormat] is set to “AVCHD”):
[Setting Values: 60p, 60i, 50p, 50i]
 - When [AResolution] is set to “1920x1080” ([AFormat] is set to “QuickTime”):
[Setting Values: 60p, 60i, 50p, 50i, 30p, 25p, 24p]
 - When [AResolution] is set to “1280x720”:
[Setting Values: 60p, 50p]
- When [System] is set to “SD”:
Fixed at either “60i” or “50i”.

↳ A Bit Rate

For selecting the bit rate to be recorded to the SD card in slot A.

The available options vary according to the settings for [System], [AResolution], and [AFormat].

- When [System] is set to “4K”:
Fixed at “150M”.
- When [System] is set to “HD” or “HD+Web”, and [AFormat] is set to “QuickTime”:
[Setting Values: 50M(YUV422), 50M(XHQ), 35M(UHQ)]
- When [System] is set to “HD” or “HD+Web”, and [AFormat] is set to “AVCHD”:
[Setting Values: 28M(HQ), 24M(HQ), 18M(SP)]
* [AResolution] is fixed at “1920x1080”.
- When [System] is set to “SD”:
Fixed at “8M”.

↳ B Format

For selecting the file format to be recorded to the SD card in slot B when [System] is set to “HD+Web”.

- QuickTime:
QuickTime file format (.MOV)
 - AVCHD:
AVCHD file format
- [Setting Values: ●QuickTime, AVCHD]

↳ **B Resolution**

For selecting the size of the image to be recorded to the SD card in slot B when [System] is set to “HD+Web”. (Horizontal x vertical)

The available options vary according to the [A]Frame Rate and [B]Format settings.

- When [B]Format is set to “QuickTime”:
[Setting Values: 960x540, 720x576, 720x480, 480x270]
- When [B]Format is set to “AVCHD”:
[Setting Values: 1440x1080, 720x576, 720x480]

Memo : _____

- When [System] is set to “4K”, “HD”, or “SD”, this item is fixed at the same setting as [A]Resolution].

↳ **B Frame Rate**

The frame rate of the image to be recorded to the SD card in slot B is fixed when [System] is set to “HD+Web”.

The value fixed varies according to the settings for [B]Format, [B]Resolution, and [A]Frame Rate.

- When [B]Format is set to “AVCHD”:
Fixed at either “60i” or “50i”.
- When [B]Format is set to “QuickTime”:
Fixed at “60i”, “50i”, “30p” or “25p”.

Memo : _____

- When [System] is set to “4K”, “HD”, or “SD”, this item is fixed at the same setting as [A]Frame Rate].

↳ **B Bit Rate**

For selecting the bit rate of the image to be recorded to the SD card in slot B when [System] is set to “HD+Web”.

The available options vary according to the [B]Format and [B]Resolution settings.

- When [B]Format is set to “AVCHD”:
[Setting Values: 9M(LP), 5M(EP), 8M]
- When [B]Format is set to “QuickTime”:
[Setting Values: 8M, 3M(HQ), 1.2M(LP)]

↳ **SD Aspect**

For setting the aspect ratio of the image when [System] is set to “SD”.

[Setting Values: ●16:9, 4:3]

Memo : _____

- For conditions other than those above, this item is fixed at “16:9”.

Rec Mode

- For selecting the record mode for recording to the SD card.
(P78 [Special Recording])
- The selectable options vary according to the [Record Format] menu settings.

Format	Frame Rate	Setting values
AVCHD	60p, 60i, 50p, 50i	Normal, Pre Rec, Interval Rec, Frame Rec
QuickTime	60p, 60i, 50p, 50i, 30p, 25p, 24p	Normal, Pre Rec, Clip Continuous, Interval Rec, Frame Rec

Memo : _____

- When [Slot Mode] is set to “Backup”, this item is fixed at “Normal”.

↳ **Pre Rec Time**

For setting the pre-recording time when [Rec Mode] is set to “Pre Rec”.

[Setting Values: ●5sec, 10sec, 15sec]

Memo : _____

- When [Main Menu] → [System] → [Record Set] → [Record Format] → [System] is set to “4K”, this item is fixed at “5sec”.

↳ **Rec Frames**

For setting the number of frames to record when [Rec Mode] is set to “Frame Rec” or “Interval Rec”.

[Setting Values: ●1frame, 3frames, 6frames]

↳ **Rec Interval**

For setting the recording time interval when [Rec Mode] is set to “Interval Rec”.

[Setting Values: ●1sec, 2sec, 5sec, 10sec, 30sec, 1min, 2min, 5min, 10min, 30min, 1hour]

Slot Mode

For setting the operation of the card slot.

- **Series:**
Mode that activates the two slots sequentially.
- **Dual:**
Mode that activates the two slots at the same time.
(☞ P74 [Dual Rec])
- **Backup:**
Mode that enables recording to slot B without using the [REC] button. This item is selectable only when [Rec Mode] is set to “Normal”. Start or stop the recording using the [Backup Rec] menu or press the [USER1] to [USER7], [LCD KEY▲], [LCD KEY▶], [LCD KEY▼], [LCD KEY◀] button that is assigned with “Backup Trig”.
(☞ P76 [Backup Rec])

Memo : _____

- This item cannot be selected when [Main Menu] → [System] → [Record Set] → [System] is set to “HD+Web”.
- When this is set to “Series”, and recordable media are inserted in both slots, pressing the [REC] button starts recording only to the card in the selected slot (active slot).
- When “Series” is selected, and [Record Format] → [AFormat] is set to “AVCHD”, the clips are recorded over the slots seamlessly without interruption in the video.
- When this is set to “Dual”, and recordable media are inserted in both slots, pressing the [REC] button starts simultaneous recording to the cards in both slots.

↳ Backup Rec

For starting/stopping backup recording with [REC]/[STBY].

This item is selectable only when [Slot Mode] is set to “Backup”.

Memo : _____

- When recording is stopped due to no remaining space on the media, etc., this item is fixed at “STOP” and cannot be selected.

4GB File Spanning(SDXC)

A recording file is automatically split when the size exceeds 4 GB, but you can record clips larger than 4 GB by setting this option to “Off”. (Up to a maximum of 64 GB or 4 hours)

- **On:**
Splits a file when it exceeds 4 GB or 30 minutes.
- **Off:**
Splits a file when it exceeds 64 GB or 4 hours.
[Setting Values: ●On, Off]

Memo : _____

- This option is only valid if the SD card used for recording is of the SDXC format.
- During simultaneous recording, such as Dual Rec and backup recording, this option is valid only when the SD cards in both slots are of the SDXC format.
- This option is valid only when [Record Format] → [AFormat]/[BFormat] is set to “QuickTime”.
(☞ P115 [A Format])
(☞ P115 [B Format])

LPCM (QuickTime)

For setting the audio recording format of QuickTime.

[Setting Values: Dual Mono, ●Stereo]

Time Stamp

For setting whether to display shooting date/time information in the recorded video.

[Setting Values: On, ●Off]

Memo : _____

- The date/time display style can be changed in [LCD/VF] → [Display Settings] → [Date Style]/[Time Style].
(☞ P108 [Date Style])
(☞ P108 [Time Style])
- When [System] is set to “4K”, this item is fixed at “Off”.

Clip Set↳ **Clip Name Prefix**

For setting the first four characters of the name of the clip file to be recorded to the SD card. Enter any of the 36 characters including alphabets (upper case) and numbers (0 to 9) using the software keyboard.

(P94 [Text Input with Software Keyboard])

[Setting Values: xxxG] (The default value of xxx is the last three digits of the serial number.)

Memo : _____

- When [Main Menu] → [System] → [Record Set] → [Record Format] → [A]Format is set to “AVCHD”, this setting is not reflected in the file name of the clip. However, it is recorded as the display name of the clip in the thumbnail display.

↳ **Reset Clip Number**

For assigning a new number (Clip Number) by resetting it (0001).

Select [Reset] and press the Set button (●) to reset the number.

When [A]Format is set to “AVCHD”, the clip number is reset to “00000”.

When other clips exist on the SD card, the smallest available number is used after reset.

- Example:
If the [Clip Name Prefix] is “ABCD”, and “ABCD0001” already exists on the SD card, “ABCD0002” will be assigned.

Clear Planning Metadata

Erases the planning metadata downloaded from the FTP server. **200**

This item also deletes the metadata loaded using the setup files (“User File”/“All File”).

Network/Settings Item 200

For specifying network-related settings.

The display of the software keyboard for input varies according to the item you are setting.

(P94 [Text Input with Software Keyboard])

Web

For setting the functions that make use of the web browser.

↳ **Web Access**

To access via a web browser, set to “On”.

[Setting Values: ●On, Off]

↳ **Camera Name**

For setting the name displayed on the web browser. Enter not more than 8 characters using the software keyboard. (Default value: HM200)

↳ **Login Name (Fixed)**

The login name is “jvc”. It cannot be changed.

↳ **Login Password**

Changes the password for accessing via a web browser.

The current password is displayed. Enter a new password directly.

Enter not more than 31 characters using the software keyboard.

Live Streaming Set

For specifying settings for distributing live video images.

Memo : _____

- Users cannot access this menu in the following cases.
 - When [Record Format] → [System] is set to “4K” or “HD+Web”
 - When [Record Format] → [Frame Rate] is set to “24p”

↳ Live Streaming

Starts live distribution when “On” is selected.

[Setting Values: On, ●Off]

Memo : _____

- “On” cannot be selected if network connection is not established.
- “On” cannot be selected when FTP is running.
- Live streaming switches to “Off” when the power is turned off.

↳ Server

For selecting the server for live streaming.

[Setting Values: ●Server1, Server2, Server3, Server4]

Memo : _____

- The setting cannot be changed during live streaming (Live Streaming set to “On”).

↳ Streaming Server

For setting the server for live streaming.

Memo : _____

- The setting cannot be changed during live streaming (Live Streaming set to “On”).

↳ Server1/Server2/Server3/Server4

- * The name that is set in [Alias] is displayed individually.
 - Alias
For setting a name to distinguish the settings of this camera recorder.
The name set in this item will be displayed in the [Server] options.
 - * The default value is “Server1/Server2/Server3/Server4”.
 - * You can enter up to 31 characters and ASCII characters.
 - Type
For setting the system to transfer videos for distribution.
[Setting Values: ●MPEG2-TS/UDP, MPEG2-TS/TCP, RTSP/RTP, ZIXI, RTMP]
- Memo : _____
- Use reception devices that are compatible with the respective transfer systems.
 - To use the “ZIXI” setting, a dedicated server is needed separately.
 - The following items that can be set vary depending on the setting of this item.

■ Destination Address

For setting details such as the host name and the IP address of the live distribution destination.

- * Enter not more than 127 characters using single-byte alphanumeric characters (a to z, 0 to 9), single-byte hyphen [-], or dot [.] .

■ Destination URL

For entering the URL of the live distribution destination beginning with “rtmp://”. There is no default value (blank).

- * You can enter up to 191 characters and ASCII characters.

■ Destination Port

Enter the network port number of the live distribution destination using an integer between 1 and 65535.

When [Type] is set to “MPEG2-TS/UDP” or “MPEG2-TS/TCP”, the default value is “6504”. If “ZIXI” is set, the default value is “2088”.

■ Stream ID

For setting the registered stream ID of the live distribution destination.

The default value varies with the product model.

- * Enter not more than 63 characters.

■ Stream Key

Enter the stream key specified at the live transmission destination.

There is no default value (blank).

- * Enter not more than 63 characters.

■ Password

For setting the [Stream ID] password.

There is no default value (blank).

- * Enter not more than 127 characters.

■ Latency

For setting the latency mode.

[Setting Values: Minimum(ZIXI Off), ●Low, Medium]

Resolution

For setting the resolution of the video image during live distribution.

The available options vary according to the settings for [A Resolution] and [A Frame Rate] under [Record Format].

A Resolution	A Frame Rate	Setting values (●: default value)
1920x1080	60p, 30p	●1920x1080, 1280x720, 720x480, 480x270
	50p, 25p	●1920x1080, 1280x720, 720x576, 480x270
	60i	●1920x1080, 720x480, 480x270
	50i	●1920x1080, 720x576, 480x270
1280x720	60p	1280x720, 720x480, 480x270
	50p	1280x720, 720x576, 480x270
720x480 (U model)	60i	720x480, 480x270
720x576 (E model)	50i	720x576, 480x270

Memo :

- The setting cannot be changed during live streaming (Live Streaming set to “On”).
- The Aspect Ratio for the live streaming image is fixed to “16:9”.

Frame & Bit Rate

For setting the frame rate and encoding bit rate of the video image during live distribution.

The available options vary according to the settings for [Resolution] and [Record Format] above, as well as [A Frame Rate].

A Frame Rate	Resolution	Setting values (●: default value)
60p, 60i, 30p	1920x1080	60i (12.0 Mbps), ●60i (8.0 Mbps), 60i (5.0 Mbps), 60i (3.0 Mbps)
	1280x720	30p (8.0 Mbps), 30p (5.0 Mbps), 30p (3.0 Mbps), 30p (1.5 Mbps)
	720x480	60i (8.0 Mbps), 60i (5.0 Mbps), 60i (3.0 Mbps), 60i (1.5 Mbps), 60i (0.8 Mbps), 60i (0.3 Mbps), 60i (0.2 Mbps)
480x270		30p (0.2 Mbps)
50p, 50i, 25p	1920x1080	50i (12.0 Mbps), ●50i (8.0 Mbps), 50i (5.0 Mbps), 50i (3.0 Mbps)
		1280x720
	720x576	50i (8.0 Mbps), 50i (5.0 Mbps), 50i (3.0 Mbps), 50i (1.5 Mbps), 50i (0.8 Mbps), 50i (0.3 Mbps), 50i (0.2 Mbps)
		480x270

Memo :

- The setting cannot be changed during live streaming (Live Streaming set to “On”).
- An encoding bit rate exceeding 8.0 Mbps cannot be selected when [Type] is set to “RTSP/RTP”.
- An encoding bit rate exceeding 5.0 Mbps cannot be selected when [Type] is set to “ZIXI” and [Latency] is set to other than “Low”, or when [Type] is set to “RTMP”.
- An encoding bit rate exceeding 3.0 Mbps cannot be selected when [Type] is set to “ZIXI” and [Latency] is set to “Low”.
- Depending on the type of network adapter used and the connection, the images and audio sound during live streaming can be choppy.

Connection Setup

For configuring the network connection settings. A [Wizard] screen will appear according to the adapter connected to the [HOST] terminal. Follow the instructions to perform the setting. You can Load, Store, and Delete the settings specified on the [Wizard] screen.

↳ Wizard

A [Wizard] appears according to the adapter connected to the [HOST] terminal. Follow the instructions.

↳ Load

Loads the settings on the [Wizard] screen.
(☞ P166 [Reading the Connection Settings File])

↳ Store

Saves the settings on the [Wizard] screen.
(☞ P165 [Saving the Connection Settings File])

↳ Delete

Deletes the saved settings.
(☞ P167 [Deleting Connection Settings])

Metadata Server

For registering the FTP server for importing the metadata and the path of the file to be imported. Up to 4 settings can be registered.

↳ Meta-FTP1 to Meta-FTP4 (The name specified in the respective [Alias] items is displayed)

- **Alias**
For setting a name to distinguish the settings of this camera recorder.
The name set in this item will be displayed in the [Import Metadata] options.
- * Enter not more than 31 characters.
- **Protocol**
For setting the protocol of the FTP server to be connected.
 - **FTP:**
Protocol that does not encrypt the incoming and outgoing data.
 - **SFTP:**
Protocol that encrypts incoming and outgoing data using SSH.

- **FTPS:**
Protocol that encrypts incoming and outgoing data using SSL or TLS. It uses an implicit mode (starts encrypted communication once connection starts).
- **FTPES:**
Protocol that encrypts incoming and outgoing data using SSL or TLS. It uses an explicit mode (starts encrypted communication after permission is granted).

[Setting Values: ●FTP, SFTP, FTPS, FTPES]

- **Server**
For setting the server name ("mystation.com", etc.) or the IP address ("192.168.0.1", etc.) of the FTP server.
- * Enter not more than 127 characters using single-byte alphanumeric characters (a to z, 0 to 9), single-byte hyphen [-], or dot [.]
- **Port**
Enter the FTP server port number to use using an integer between 1 and 65535.
The default value varies with the Protocol setting.
(FTP: 21, SFTP: 22, FTPS: 990, FTPES: 21)
- **File Path**
Enter the path name for the metadata file ("/pub/meta.xml", "/home/user/meta2.xml", etc.)
- * Enter not more than 127 characters.
- **Username**
Enter the user name for connecting to the FTP server.
- * Enter not more than 31 characters.
- **Password**
Enter the password for connecting to the FTP server.
- * Enter not more than 31 characters.
- **PASV Mode**
For setting whether to set the communication mode used for file transfer to the passive mode. Set to "On" if the camera is inside a firewall, and a connection from the FTP server to the camera cannot be established.
[Setting Values: On, ●Off]

Memo : _____

- When [Protocol] is set to "SFTP", this item appears as "---" and cannot be selected.

Clip Server

For setting the server and directory for uploading recorded clips in the SD card to the FTP server.

↳ Clip-FTP1 to Clip-FTP4 (The name specified in the respective [Alias] items is displayed)

- **Alias**
For setting a name to distinguish the settings of this camera recorder.
The name set in this item will appear on the [FTP Upload] action screen of the thumbnail display.
* Enter not more than 31 characters.
- **Protocol**
For setting the protocol of the FTP server to be connected.
 - **FTP:**
Protocol that does not encrypt the incoming and outgoing data.
 - **SFTP:**
Protocol that encrypts incoming and outgoing data using SSH.
 - **FTPS:**
Protocol that encrypts incoming and outgoing data using SSL or TLS. It uses an implicit mode (starts encrypted communication once connection starts).
 - **FTPES:**
Protocol that encrypts incoming and outgoing data using SSL or TLS. It uses an explicit mode (starts encrypted communication after permission is granted).
 [Setting Values: ●FTP, SFTP, FTPS, FTPES]
- **Server**
For setting the server name ("mystation.com", etc.) or the IP address ("192.168.0.1", etc.) of the FTP server.
* Enter not more than 127 characters using single-byte alphanumeric characters (a to z, 0 to 9), single-byte hyphen [-], or dot [.]
- **Port**
Enter the FTP server port number to use using an integer between 1 and 65535.
The default value varies with the Protocol setting.
(FTP: 21, SFTP: 22, FTPS: 990, FTPES: 21)

- **Dir. Path**
Enter the path name for the directory to upload to ("/pub", "/home/user", etc.)
* Enter not more than 127 characters.
- **Username**
Enter the user name for connecting to the FTP server.
* Enter not more than 31 characters.
- **Password**
Enter the password for connecting to the FTP server.
* Enter not more than 31 characters.
- **PASV Mode**
For setting whether to set the communication mode used for file transfer to the passive mode. Set to "On" if the camera is inside a firewall, and a connection from the FTP server to the camera cannot be established.
[Setting Values: On, ●Off]

Memo : _____

- When [Protocol] is set to "SFTP", this item appears as "---" and cannot be selected.

Reset Network

Restores all items in the [Network] menu to their default settings.

Adding/Editing Frequently Used Menu Items (Favorites Menu)

You can select and add/edit frequently used menu items freely to create a personal menu screen (Favorites Menu).

Memo : _____

- [Favorites Menu] is only enabled in the Camera mode. [Favorites Menu] remains unchanged even when the recording format changes.
- Up to 20 menu items can be added.
- Added items in [Favorites Menu] will not be reset even when [Main Menu] → [Reset All] is executed.
- Long descriptive names may be displayed for the menu items in [Favorites Menu] to enable better understanding.

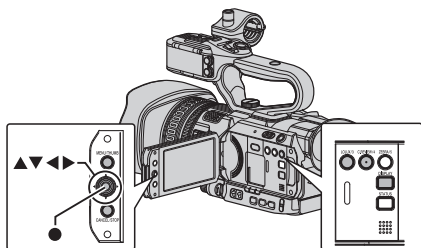

Adding Menu Items to Favorites Menu

- 1 Press the [MENU] button to open the [Main Menu] screen.
- 2 Select the menu or submenu item to add.

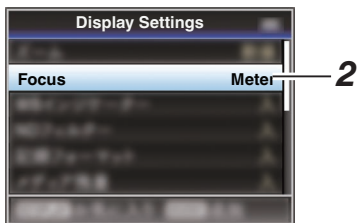

Memo : _____

- Adding items to [Favorites Menu] cannot be performed in the following cases. [USER3 Add] is displayed in gray in the operation guide.
 - Selected item is already added to [Favorites Menu].
 - Number of menu items that can be added (20 items) is exceeded.

- 3 Press the [LOLUX/3] button.
A screen to confirm the addition appears.
- 4 Select [Add] and press the Set button (●).
The selected menu item is added to [Favorites Menu].



Editing Favorites Menu

You can delete or change the order of the items added to [Favorites Menu].

Deleting Items from [Favorites Menu]

1 Open the [Favorites Menu] screen.

- ① Press the [MENU] button to open the [Main Menu] screen.
- ② Press the [DISPLAY] button or press and hold down the [MENU] button to open the [Favorites Menu] screen.

2 Select [Edit Favorites] and press the Set button (●) or crossed-shaped button (▶).

The header turns magenta and the editing mode is activated.

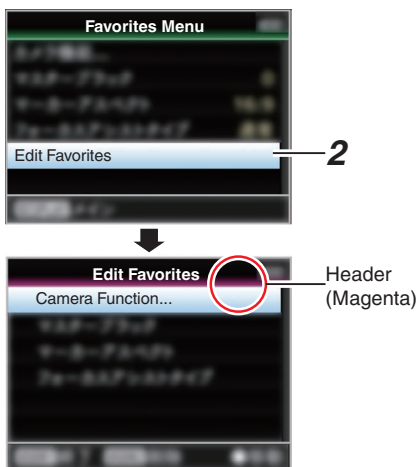

3 Select the menu or submenu item to delete.

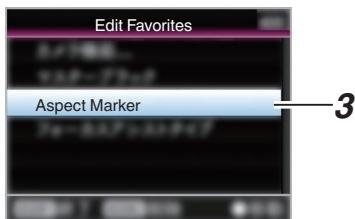

4 Press the [C.REVIEW/4] button.

A delete mark (X) appears at the beginning of the menu item.

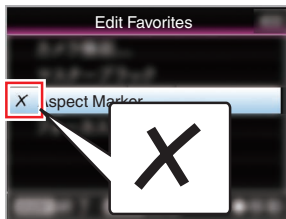

Memo : _____

- When the [C.REVIEW/4] button is pressed again while the menu item with the delete mark (X) is selected, the menu item will be excluded from the items to be deleted and the delete mark (X) disappears.

5 Press the [LOLUX/3] button.

The option menu to exit the [Favorites Menu] editing mode appears.

6 Select [Save & Exit] and press the Set button (●).

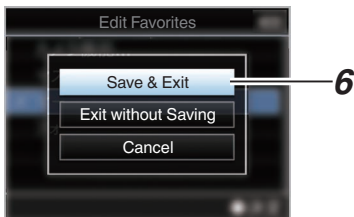

Memo : _____

- Deletion is not complete until the changes are saved with [Save & Exit].
- To exit the editing mode without deleting any items, select [Exit without Saving].
- To return to the editing mode, select [Cancel].

Changing the Order of Items in [Favorites Menu]

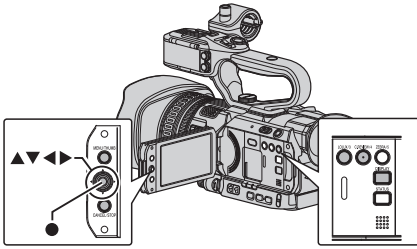

- 1 Open the [Favorites Menu] screen.**
Press the [MENU] button to open the [Favorites Menu] screen.
- 2 Select [Edit Favorites] and press the Set button (●) or crossed-shaped button (⬮).**
The header turns magenta and the editing mode is activated.

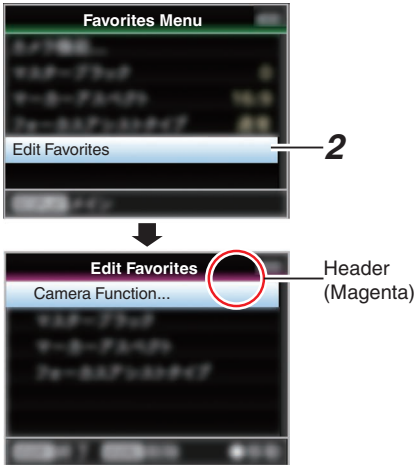

- 3 Select the menu or submenu item to move and press the Set button (●).**

The moving mode is activated and a position selection bar for the move appears.

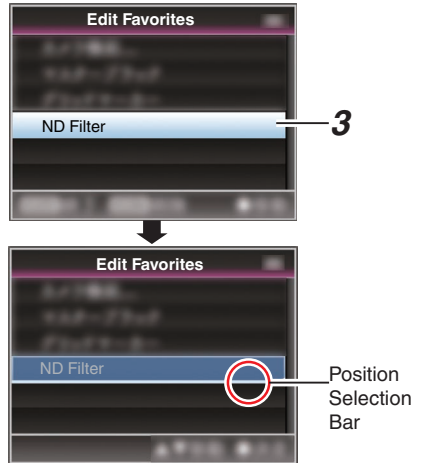

- 4 Select the position to move to with the cross-shaped button (⬮⬭).**
Move the position selection bar with the cross-shaped button (⬮⬭) and select a position to move to.
- 5 Press the Set button (●).**
The selected item moves to the new position.

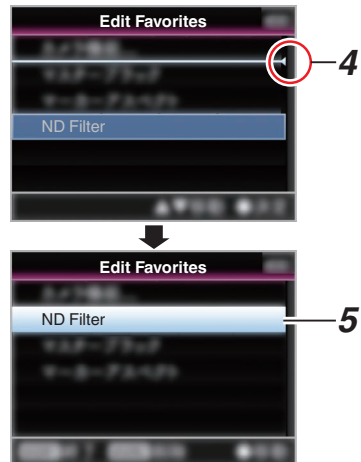

6 Press the [LOLUX/3] button.

The option menu to exit the [Favorites Menu] editing mode appears.

7 Select [Save & Exit] and press the Set button (●).

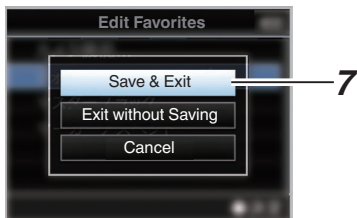

Memo : _____

- Moving is not complete until the changes are saved with [Save & Exit].
 - To exit the editing mode without saving any changes, select [Exit without Saving].
 - To return to the editing mode, select [Cancel].
- _____

Display Screen in Camera Mode

Display 0 screen

This screen displays the event. It is also used to display warnings only.

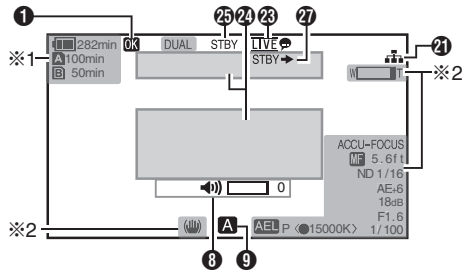

- *1 Appears only during warnings
- *2 Appears only during operation

Display 1 screen

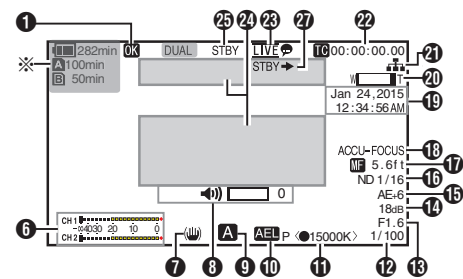

- * Appears only during warnings

Display 2 screen

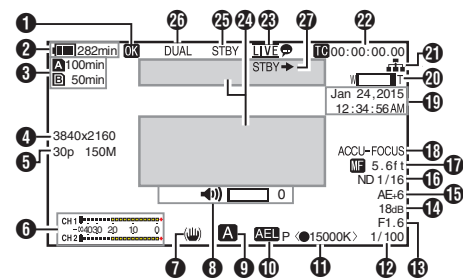

- ① OK Mark
Displayed when OK mark has been appended.
(☞ P88 [Appending/Deleting OK Mark])
- ② Voltage/Battery Power
Displays the current status of the power supply in use.
(☞ P31 [Power Status Display])

Memo : _____

- Displayed in the Display 0 and Display 1 screens during warnings only.

- ③ Remaining Space on Media
Displays the remaining recording time of the SD cards in slot A and slot B separately.

- A** : Currently selected slot. (White card)
- A** : Write-protect switch of SD card is set.
- A!**INVALID : SD card cannot be read or written to, or restored.
- A!**FORMAT : SD card requires formatting.
- A!**RESTORE : SD card requires restoring.
- A!**INCORRECT :

- When an SD card lower than UHS-I U3 is inserted while in the 4K mode.
- When Record Set is set to other than “AVCHD”/“SD”/“Web” with a Class 4 SD card inserted.
- When the SD card is not supported.
- When an SD card lower than Class 10 is inserted while in the XHQ mode.

- A!**REC INH :
- When attempting to record in 50i(HQ)/50i(SP) to an SD card recorded in AVCHD60i(HQ)/60i(SP) (or vice versa).
- When attempting to record more than 4 GB while a media that does not support recording of more than 4 GB is inserted.
(☞ P117 [4GB File Spanning(SDXC)])

The following icons are displayed during FTP upload.
[200]
(☞ P148 [Uploading a Recorded Video Clip 200])

Icon	Status
	FTP transfer is in progress. Three images are alternately displayed, and the arrows become animated. In this case, instead of the recordable time of the SD card, an estimated value of the remaining transfer time is displayed.
 (Yellow)	Error has occurred during FTP transfer.

Memo : _____

- This item is not displayed when [Main Menu] → [LCD/VF] → [Display Settings] → [Media Remain] is set to “Off”. However, warnings will be displayed.
(☞ P107 [Media Remain])
- Displayed on the Display 0 and Display 1 screens only in the case of warnings. (When the remaining time is shorter than 3 minutes)
The icons appear on all display screens in the following cases.
 - When recording is performed to only one of the slots while [Main Menu] → [System] → [Record Set] → [Slot Mode] is set to “Dual”.
(☞ P117 [Slot Mode])
 - When recording is performed to only one of the slots while [Main Menu] → [System] → [Record Set] → [Record Format] → [System] is set to “HD+Web”.
(☞ P115 [System])
- The displayed time is an estimate.

4 Resolution

Displays the video image resolution.

Memo : _____

- This item is not displayed when [Main Menu] → [LCD/VF] → [Display Settings] → [Record Format] is set to “Off”.
(☞ P107 [Record Format])

5 Frame Rate/Bit Rate

Displays the frame rate and bit rate in pairs.

Memo : _____

- This item is not displayed when [Main Menu] → [LCD/VF] → [Display Settings] → [Record Format] is set to “Off”.
(☞ P107 [Record Format])

6 Audio Level Meter

- Displays the audio levels of CH1 and CH2.
- The icon appears on the screen when in Manual mode.



- When [Main Menu] → [System] → [Record Set] → [Rec Mode] is set to “Frame Rec” or “Interval Rec”, audio cannot be recorded and the audio level meter is grayed out.

Memo : _____

- This item is not displayed when [Main Menu] → [LCD/VF] → [Display Settings] → [Audio Meter] is set to “Off”.
(☞ P107 [Audio Meter])

7 Image Stabilizer Mark

Displayed when the image stabilizer is ON.

- : When [Level] of [OIS] is set to “Normal”.
- : When [Level] of [OIS] is set to “High”.

Memo : _____

- If image stabilizer is set to “OFF” when the Display 0 screen is displayed, appears for 3 seconds.
- Displayed in the Display 0 screen only when there is a change.

8 Volume Operation Indicator

The display appears when the volume (0 to 15) of the headphone or speaker changes.



Memo : _____

- There is no audio output from the speaker in Camera mode.

9 FULL AUTO ON/OFF

Press and hold the [FULL AUTO] button to switch on or off.
If FULL AUTO is enabled, the icon appears.

- 10 AE Lock**
The **AE** icon is displayed during AE lock.
- 11 White Balance Mode**
Displays the current white balance mode.
(****K indicates color temperature)
- A<****K> : When the white balance is set to A.
- B<****K> : When the white balance is set to B.
- P<****K> : When the white balance is set to PRST.
- P<●****K> : The color temperature setting with respect to the Auto WB value is appropriate when white balance is set to PRST and the WB indicator to “On”,
- <WBL> : Locked in the Full Auto White Balance mode.
(☞ P107 [WB Indicator])

Memo : _____

- Displayed in the Display 0 screen only when there is a change.
-
- 12 Shutter**
- The current shutter speed is displayed when the shutter is set to “Manual”.
(☞ P96 [Shutter])
 - The shutter speed display disappears when the [FULL AUTO] button is pressed and held down to set to “ON” to enable the Full Auto shooting mode, or when the [SHUTTER] button is pressed to enable the Automatic Shutter mode.

Memo : _____

- The variable range of the shutter speed varies according to the video format settings.
(☞ P58 [Setting the Electronic Shutter])
 - Displayed in the Display 0 screen only when there is a change.
-
- 13 Iris F-Number**
Displays F-number of the lens iris.
(☞ P55 [Adjusting the Iris])

- 14 Gain**
- Displays the gain value when in the Manual Gain mode.
 - The gain value is not displayed in the “AGC” mode.
 - “LUX30” or “LUX36” is displayed when in the low-light shooting mode.

Memo : _____

- Displayed in the Display 0 screen only when there is a change.
-

- 15 AE Level**
- Displayed when the AE function is activated.
 - When operated while manual operation is disabled, “AE” blinks for about 5 seconds.
 - When face detection is enabled and [Face Detect] is set to “AF&AE”, **AE** appears on the left side of “AE”.
(☞ P53 [Adjusting the Focusing by Face Detection])

- 16 ND Filter Position**
Displays the current ND filter position.

Memo : _____

- This item is not displayed when [Main Menu] → [LCD/VF] → [Display Settings] → [ND Filter] is set to “Off”.
(☞ P107 [ND Filter])
 - Displayed in the Display 0 screen only when there is a change.
-

- 17 Focus Display**
- Displays the value of the focal length during manual focus.
 - There is no icon display in Auto Focus mode. However, the Auto Focus icon **AF** appears with **AF** only when face detection is enabled.
(☞ P53 [Adjusting the Focusing by Face Detection])
(☞ P98 [Face Detect])
 - If [Main Menu] → [Camera Function] → [AF Assist] is set to “Area”, the [] icon appears on the left side of **AF**.
(☞ P97 [AF Assist])

Memo : _____

- You can specify whether to display the focus value (“Feet”/“Meter”) or turn off the display in [Main Menu] → [LCD/VF] → [Display Settings] → [Focus].
This item will not be displayed when “Off” is selected.
(☞ P107 [Focus])
 - Displayed in the Display 0 screen only when there is a change.
-

18 Focus Assist

- “FOCUS” is displayed when auto focus is activated.
- When ACCU-Focus is enabled, “ACCU-FOCUS” blinks for about 10 seconds while Focus Assist starts up, after which the “FOCUS” indicator lights up.
- If recording starts while [ACCU-Focus] is active, [ACCU-Focus] will be forcibly deactivated.

(☞ P105 [Focus Assist])

Memo : _____

- Displayed in the Display 0 screen only when there is a change.

19 Date/Time Display

Displays the current date and time.

Memo : _____

- The date/time display style can be specified in [Main Menu] → [LCD/VF] → [Display Settings] → [Date Style]/[Time Style].
(☞ P108 [Date Style])
(☞ P108 [Time Style])
- This item is not displayed when [Main Menu] → [LCD/VF] → [Display Settings] → [Date/Time] is set to “Off”.
(☞ P108 [Date/Time])
- When [Main Menu] → [System] → [Record Set] → [Time Stamp] is set to “On”, this item is not displayed.
(☞ P117 [Time Stamp])

20 Zoom Display

- Displays the zoom position. (Zoom bar or value)

Dynamic Zoom Off:



Dynamic Zoom On:



- The zoom bar will only be displayed for 3 seconds after the zoom operation is activated.
 - The value will always be displayed.
- Dynamic Zoom Off : Z00 to 99
Dynamic Zoom On : Z100 to 149





Memo : _____

- You can specify the display method (Number/Bar) and whether to turn off the display in [LCD/VF] → [Display Settings] → “Zoom”.
This item will not be displayed when “Off” is selected.
(☞ P107 [Zoom])
- Displayed in the Display 0 screen only when there is a change.

21 Network Connection Icon **200**

The network connection status is displayed when [Main Menu] → [System] → [Network] is set to “On”.

This icon is not displayed when “Off” is selected.
(☞ P113 [Network **200**])

Icon	Status
 (Blink)	Connection is not established (starting up, preparing for connection)
 (Yellow)	Connection is not established (preparing for connection)
	Connection is established
	When a USB adapter different from the connection settings is detected
(No display)	When an incompatible USB adapter is detected, or when [Network] is set to “Off”

Memo : _____

- When a cellular adapter that supports LTE connection display is in use, “LTE” will appear to the left of the above icon when LTE connection is detected.

22 Time Code (TC)/User’s Bit (UB) Display

- Displays the time code (hour: minute: second: frame) or user’s bit data recorded in the SD card being played back.
- Example of time code display:



* Colon (:) denotes non-drop frames and dot (.) denotes drop frames.



- Example of user’s bit display:



Memo : _____

- You can specify whether to display the time code, user's bit, or turn off the display in [LCD/VF] → [Display Settings] → [TC/UB]. This item will not be displayed when "Off" is selected.
(☞ P107 [TC/UB])

- 23 Live streaming mark **200**
When [Main Menu] → [System] → [Network]/[Settings] → [Live Streaming Set] → [Live Streaming] is set to "On", the distribution status is displayed.
(☞ P119 [Live Streaming])

Icon	Status
 (Red)	Distribution in progress (good connection quality)
 (Red)	Distribution in progress (poor connection quality)
 (Yellow)	Connection pending or connection failed

- 24 Event/Warning Display Area
Displays error messages.
(☞ P170 [Error Messages and Actions])
- 25 Media Status
---- : No card found in the selected slot
- STBY : Recording standby
- REC : Recording
- REVIEW : Clip Review
(☞ P73 [Viewing Recorded Videos Immediately (Clip Review)])
- STBY **P** : Pre Rec recording standby
(☞ P78 [Pre Rec])
- REC **P** : Pre Rec recording
(☞ P78 [Pre Rec])
- STBY **C** : Clip Continuous Rec recording standby
(☞ P79 [Clip Continuous Rec])

- REC **C** : Clip Continuous Rec recording
(☞ P79 [Clip Continuous Rec])
- STBY **C** : Clip Continuous Rec recording
(displayed in pause
yellow)
(☞ P79 [Clip Continuous Rec])
- STBY **I** : Interval Rec recording standby
(☞ P81 [Interval Rec])
- STBY **I** : Interval recording pause
(displayed in red)
- REC **I** : Interval Rec recording
(☞ P81 [Interval Rec])
- STBY **F** : Frame Rec recording standby
(☞ P80 [Frame Rec])
- REC **F** : Frame Rec recording
(☞ P80 [Frame Rec])
- STBY **F** : Frame Rec recording pause
(displayed in yellow)
(☞ P80 [Frame Rec])
- STOP : Unable to record to the card in the slot
- P.OFF : Power OFF

- 26 Dual Rec/Backup Rec Display
"DUAL" is displayed in the Dual Rec mode and "BACKUP" is displayed in the Backup Rec mode.
(☞ P117 [Slot Mode])

Memo : _____

- This item is not displayed when [Slot Mode] is set to "Series".
- This item is not displayed when [Main Menu] → [LCD/VF] → [Display Settings] → [Media Remain] is set to "Off". However, warnings will be displayed.
(☞ P107 [Media Remain])
- Displayed in the Display 0 and Display 1 screens during warnings only. (When the remaining time is shorter than 3 minutes)

- 27 SDI Record Trigger **200**
- STBY → : When [SDI Rec Trigger] is set to "On" and recording is stopped
- REC → : When [SDI Rec Trigger] is set to "On" and recording is in progress

Display Screen in Media Mode

Media Display 0 Screen

This screen displays the media status or event. It is also used to display warnings only.

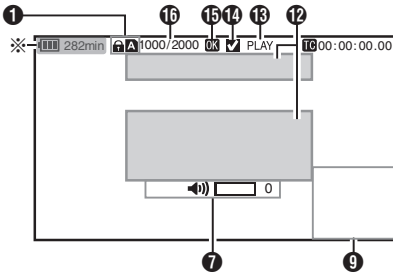

* Appears only during warnings

Media Display 1 Screen

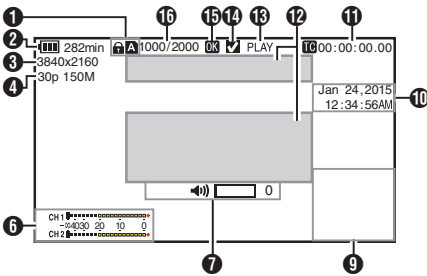

Media Display 2 Screen

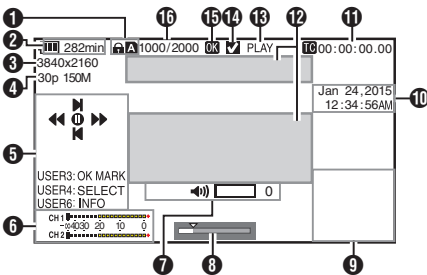

- 1 Media
 - Displays the media slot (A or B) of the currently played clip.
 - appears when the write-protect switch of the SD card is set.
- 2 Voltage/Battery Power
 - Displays the current status of the power supply in use.
 - (P31 [Power Status Display])

Memo : _____
 • Displayed in the Media Display 0 screen during warnings only.

- 3 Resolution
 - Displays the video image resolution.
- 4 Frame Rate/Bit Rate
 - Displays the frame rate and bit rate in pairs.
- 5 Operation Guide
 - Displays a guide for the current operation buttons.
- 6 Audio Level Meter
 - Displays the audio levels of CH1 and CH2.



Memo : _____
 • This item is not displayed when [Main Menu] → [LCD/VF] → [Display Settings] → [Audio Meter] is set to "Off".
 (P107 [Audio Meter])

- 7 Volume Operation Indicator
 - The display appears when the volume (0 to 15) of the headphone or speaker changes.
 - (P128 [Volume Operation Indicator])
- 8 Position bar
 - Displays the current position in the video. During trimming, the position bar appears in green, and icons for the in and out points are displayed.
 - : Current position of the video
 - : Position to start trimming (In point)
 - : Position to end trimming (Out point)

- 9** Information Display
The camera information display turns on and off each time you press the [OIS/6] button.
- Camera information display displays only information of Gain, Iris, Shutter and White Balance that have been recorded.

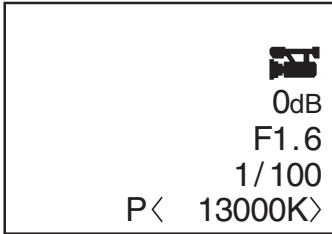

Camera Information Display

Memo : _____

- Trimming information is displayed while trimming is in progress. In this case, pressing the [OIS/6] button does not switch the display.

- 10** Date/Time Display
Displays the date/time that is recorded on the currently played SD card.

Memo : _____

- The date/time display style can be specified in [LCD/VF] → [Display Settings] → [Date Style]/[Time Style].
(P108 [Date Style])
(P108 [Time Style])

- 11** Time Code (TC)/User's Bit (UB) Display
- Displays the time code (hour: minute: second: frame) or user's bit data recorded in the SD card being played back.
 - Example of time code display:

TC00:00:00:00
※

- * Colon (:) denotes non-drop frames and dot (.) denotes drop frames.

- Example of user's bit display:

UBFF EE DD 20

Memo : _____

- You can specify whether to display the time code, user's bit, or turn off the display in [TC/UB] of [Main Menu] → [LCD/VF] → [Display Settings].

(P107 [TC/UB])

- 12** Event/Warning Display Area
Displays error messages.
(P170 [Error Messages and Actions])

- 13** Media Status

PLAY : Playing
STILL : Still picture playback mode
FWD * : High-speed playback in the forward direction (* playback speed: 5x, 15x, 60x, or 360x)
REV * : High-speed playback in the reverse direction (* reverse playback speed: 5x, 15x, 60x, or 360x)
STOP : Stop mode
P.OFF : Power OFF

- 14** Check Mark
Displayed when the currently played clip is selected.

- 15** OK Mark
Displayed when OK mark has been appended.
(P88 [Appending/Deleting OK Mark])

- 16** Clip Information
Displays current clip number/total number of clips.

Status Screen

For checking the settings of the camera recorder.

Camera 1 Screen/Camera 2 Screen

For checking information related to shooting using the camera recorder.

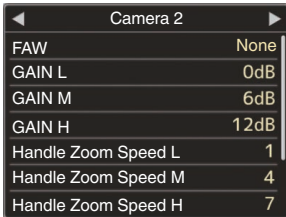
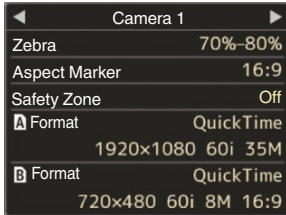

USER Switch Set Screen

For checking the status (functions assigned) of the user buttons.

(P39 [Assignment of Functions to User Buttons])

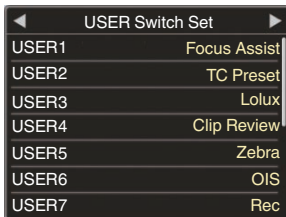

Audio Screen

For checking settings related to audio level and audio.

(P110 [Audio Set Item])

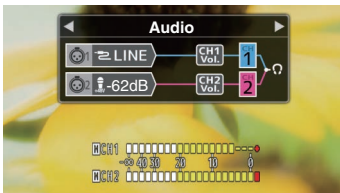

Video Screen

For checking the settings related to video output.
(P109 [Video Set Item])

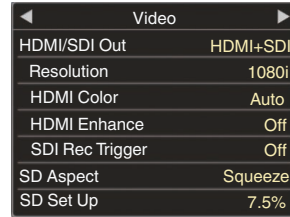

Planning Metadata Screen

For checking the current planning metadata setting.

(P151 [Planning Metadata])

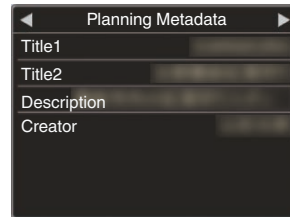

Network Screen 200

For checking the network-related settings.
(P121 [Wizard])

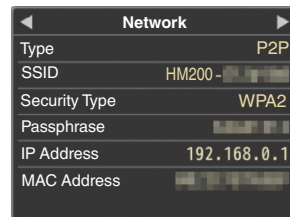

Marker and Safety Zone Displays (Camera Mode Only)

The marker and safety zone displays are useful in helping you determine the angle of view for the image according to the shooting purpose. The marker is displayed only in the Camera mode.

Displaying the Grid Marker

1 Set [LCD/VF] → [Marker Settings] → [Grid Marker] to “On”.

(☞ P106 [Grid Marker])

A grid that divides the screen into 3x3 is displayed.



Memo : _____

- When [Grid Marker] is set to “On”, [Aspect Ratio], [Aspect Marker], and [Safety Zone] do not function.

- Example of display when [Aspect Ratio] = “4:3”, [Aspect Marker] = “Line+Halftone”, and [Center Mark] = “On”

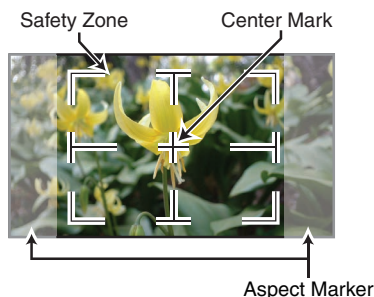

Memo : _____

- You can turn On/Off the safety zone and center mark displays using [LCD/VF] → [Marker Settings] → [Aspect Ratio], [Safety Zone], and [Center Mark].

(☞ P106 [Safety Zone])

Color Bar Output

Color bars can be output on this camera recorder.

Memo : _____

- The audio test signals (1 kHz) can be output simultaneously with the color bar output. (☞ P112 [Test Tone])

To Output the Color Bar Using the Menu

To output color bars, follow the setting procedure below.

1 Set [Camera Function] → [Bars] to “On”.

(☞ P96 [Bars])

Color bars are output.

To Output the Color Bar Using the User Button

1 Assign the “Bars” function to any of the user buttons.

(☞ P39 [Assignment of Functions to User Buttons])

2 Press the user button that is assigned with “Bars”.

Color bars are output.

Configuring Setup Files

The menu settings can be stored on an SD card by saving them as a setup file.

Loading a saved setup file enables you to reproduce the appropriate setup state speedily. The following types of setup files are available.

■ **Picture file:**

File that contains image creation settings in accordance to the shooting conditions ([Camera Process] menu items).

■ **All File:**

File that contains all menu settings, ranging from video format settings to image creation settings such as device settings and shooting conditions, as well as the contents of the [Favorites Menu].

■ **User File:**

File that contains settings from All File that are not included in the [Camera Process] menu items.

(P100 [Camera Process Menu])

Memo : _____

- Make use of the [Setup File] menu to save or load a setup file.
- The following operations can be performed on the [Setup File] menu.
 - [Saving Setup Files] (P 136)
 - [Loading a Setup File] (P 137)

Number of Storable Setup Files

SD slot A : [**A** 1] to [**A** 8]

SD slot B : [**B** 1] to [**B** 8]

Compatibility

■ **User File/All File**

- Only User File/All File of the GY-HM200 and GY-HM170 series can be loaded.
- When User File/All File saved using GY-HM200 are loaded using GY-HM170, the functions that only exist on GY-HM200 are ignored.

■ **Picture file**

Only picture files of the GY-HM200 and GY-HM170 series can be loaded.

| Saving Setup Files

1 **Display the [Setup File] menu.**

Select [Main Menu] → [System] → [Setup File] and press the Set button (●).
(P113 [Setup File])

2 **Select [Store File] and press the Set button (●).**

3 **Select [Picture File], [User File] or [All File], and press the Set button (●).**

The existing files are displayed.

4 **Select the file to be newly saved (or overwritten) using the cross-shaped button (▲▼), and press the Set button (●).**

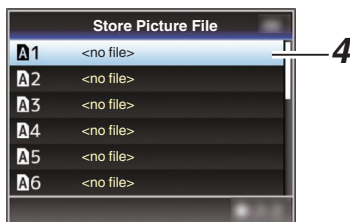

Memo : _____

- Files cannot be written in the following cases. (Displayed in gray, selection disabled)
 - When the inserted SD card is not supported or not formatted. (File name appears as “---”.)
 - When a write-protected SD card is inserted (a mark appears beside the SD card icon).

5 **Name the file.**

- Enter the subtitle using the software keyboard.
(P94 [Text Input with Software Keyboard])
- You can enter up to 8 characters for the [Store File]/[Picture File] subtitle.

Memo : _____

- When overwriting an existing file, the subtitle of the existing file is displayed.
- Select [Cancel] and press the Set button (●), or press the [CANCEL] button to return to the previous screen.

6 Select [Store] and press the Set button (●).



7 Save the file.

- A confirmation screen appears when you choose to overwrite. Select [Overwrite] on the confirmation screen, and press the Set button (●). Saving starts, and “Storing...” appears on the screen.

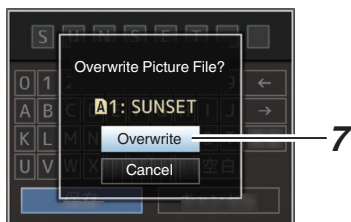

- Saving starts, and “Storing...” appears on the screen when the file is newly saved.

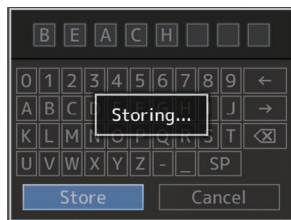

8 Saving is complete.

After saving of the file is complete, “Complete” appears on the screen, and the menu screen closes automatically.

Loading a Setup File

1 Display the [Setup File] menu.

Select [Main Menu] → [System] → [Setup File] and press the Set button (●).
(☞ P113 [Setup File])

2 Select [Load File] and press the Set button (●).

3 Select [Picture File], [User File] or [All File], and press the Set button (●).

The existing files are displayed.

4 Select the file to load using the cross-shaped button (▲▼), and press the Set button (●).

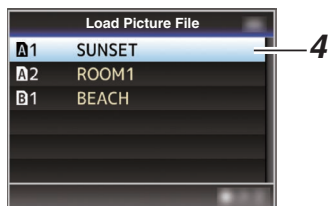

Memo : _____

- When the write-protect switch of the inserted SD card is set, a lock mark appears beside the SD card icon. Setup files can be loaded from an SD card even if the write-protect switch is set.
- Setup files that are completely incompatible will not be displayed.
(☞ P136 [Configuring Setup Files])

5 Select [Load] on the confirmation screen, and press the Set button (●).

Loading starts, and “Loading...” appears on the screen.

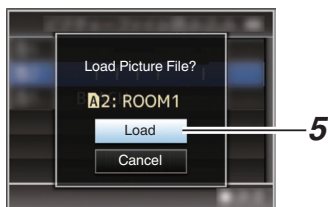

6 Reading is complete.

After reading of the file is complete, “Complete” appears on the screen, and the menu screen closes automatically.

Connecting External Monitor

- To output live or playback video images and audio sound to an external monitor, select the output signals from the camera recorder, and connect using an appropriate cable according to the monitor to be used.
- Choose the most suitable terminal according to the monitor in use.
- [SDI OUT] terminal **200**:
Outputs either the 3G-SDI/HD-SDI signal or SD-SDI signal.
- [AV] terminal:
Outputs composite video and audio signals.
- [HDMI] terminal:
Outputs HDMI signals.

Memo :

- If the [SDI OUT] terminal or [HDMI] terminal is connected, configure the settings in the [A/V Set] menu according to the monitor to be connected.
(☞ P109 [HDMI/SDI Out **200**])
(☞ P109 [HDMI Out **170**])

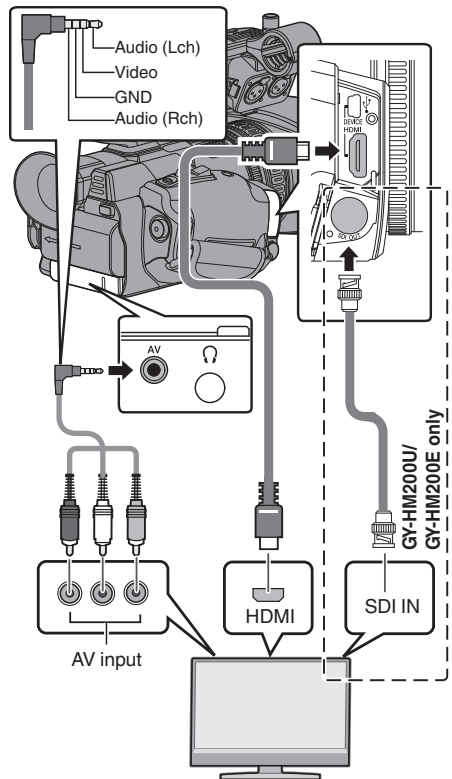

- * Select the output signal in [A/V Set] → [HDMI/SDI Out].
(☞ P109 [HDMI/SDI Out **200**])
- * When [Record Format] → [System] is set to “SD”, only SD-SDI signals are output.
(☞ P115 [System])
- * To display the menu screen or display screen on an external monitor, set [A/V Set] → [Video Set] → [Display On TV] to “On”.
(☞ P109 [Display On TV])

Connecting via SDI 200

- Digital video signals, together with embedded (superimposed) audio signals and time code signals, are output for both the 3G-SDI/HD-SDI and SD-SDI signals.

Memo : _____

- The sampling frequency for embedded (superimposed) audio signals is 48 kHz. Time code of the built-in time generator as well as playback time code are also output.

Setting the Aspect

- For setting the mode to convert images with a 16:9 aspect ratio to display on a 4:3 aspect ratio screen.
- Set using [A/V Set] → [Video Set] → [SD Aspect].
- The available modes include “Letter” (blackened at the top and bottom) and “Squeeze” (full size, compressed at the left and right).
(☞ P110 [SD Aspect])

Memo : _____

- When [Record Format] → [System] is set to “SD”, and [SD Aspect] is set to “4:3”, this item cannot be selected.
(☞ P115 [System])
(☞ P116 [SD Aspect])

Connecting the Headphone

- Select the audio output from the [Ω] terminal using [A/V Set] → [Monitor].
(☞ P112 [Monitor])

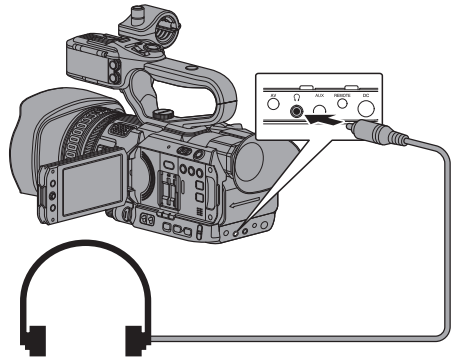

Memo : _____

- There is no sound output from the speaker when the headphone is connected.

Connecting Wired Remote Control

You can operate the functions of this unit with a wired remote control.

Memo : _____

- When the switches of the camera recorder and remote control unit are operated at the same time, the switch operation of the remote control unit takes priority over that of the camera recorder.

1 Connect a wired remote control to the camera recorder.

Connect the wired remote control (sold separately) to the [REMOTE] terminal of this camera recorder.

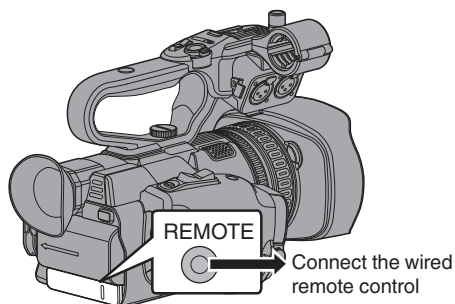

Caution : _____

- Turn off the power of the camera recorder when connecting a wired remote control.

2 Turn on the power of the camera recorder.

Loading Clips to the PC

- You can load clips to a PC by connecting the camera recorder to the PC via the USB port. Doing so enables clips stored in the SD card to be managed and edited on the PC.
- Files on the SD card can be managed/edited on the connected PC in this mode only for USB mass storage class devices that are recognized by the said PC as a peripheral drive.

Memo : _____

- Files cannot be written to the SD card.

1 Connect the camera recorder to the PC using a USB cable.

A confirmation message “Change to USB Mode?” to enable the USB connection appears.

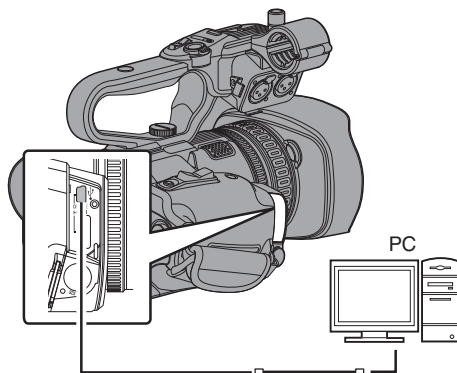

2 Select [Change] using the cross-shaped button (▲▼), and press the Set button (●).

The camera recorder switches to USB mode.



Memo : _____

- If recording is in progress, the “Change to USB Mode?” message appears after recording stops.
- If playback is in progress, the camera recorder switches to USB mode after the file closes automatically, such as when playback stops.

Disconnecting

- Disable the connection on the PC, then remove the USB cable from the camera recorder.
- Doing so exits the USB mode and switches the camera recorder to Camera mode.

Memo : _____

- The procedure for disabling the USB connection varies according to the PC in use. For details, refer to the instruction manual of the PC.

When your PC cannot recognize the SD card

Confirm and update the OS of your PC.

OS	Description
Windows Vista	Necessary to update to SP1 or higher.
Windows Vista SP1/ Windows Vista SP2	Necessary to download the update software. (KB975823) <ul style="list-style-type: none"> • 32 bit version http:// www.microsoft.com/downloads/en/details.aspx?FamilyID=2d1abe01-0942-4f8aabb2-2ad529de00a1 • 64 bit version http:// www.microsoft.com/downloads/en/details.aspx?FamilyID=7d54c53f-017c-4ea5-ae08-34c3452ba315
Windows 7	Necessary to download the update software. (KB976422) <ul style="list-style-type: none"> • 32 bit version http:// www.microsoft.com/downloads/en/details.aspx?FamilyID=3ee91fc2-a9bc-4ee1-aca3-2a9aff5915ea • 64 bit version http:// www.microsoft.com/downloads/en/details.aspx?FamilyID=73f766dd-7127-4445-b860-47084587155f

Functions of Network Connection **200**

- The network function can be operated by connecting one of the following adapters to the [HOST] terminal at the side terminal section.
 - Wireless LAN adapter
 - Ethernet adapter
 - Cellular adapter(☞ P143 [Camera Setup for Network Connection])
- The network feature comprises web-browser-based functions using devices such as a smartphone, tablet terminal, or PC, as well as FTP and live streaming functions that run via thumbnail screens and menu operation.

List of Functions

Importing Metadata

You can download a metadata settings file (XML format) from the FTP server and store metadata in the camera recorder.

(☞ P146 [Importing Metadata **200**])

Uploading Recorded Clips

You can upload clips recorded in the SD card to a preset FTP server.

(☞ P148 [Uploading a Recorded Video Clip **200**])

Memo : _____

- Uploading can also be performed via a web browser.
(☞ P155 [Uploading a Recording Clip via a Web Browser **200**])

Editing Metadata

- Planning Metadata
You can access the page for editing the camera recorder's metadata via a web browser on devices such as a smartphone, tablet terminal, or PC, and edit the metadata that is to be applied to clips to be recorded.
(☞ P151 [Planning Metadata])
- Clip Metadata
You can access the page for editing the metadata via a web browser on devices such as a smartphone, tablet terminal, or PC, and display or rewrite the metadata that is recorded to a clip.
(☞ P152 [Clip Metadata])

View Remote

You can access via a web browser on devices such as a smartphone, tablet terminal, or PC to check the live image or remotely control the camera.

(☞ P158 [View Remote Feature **200**])

Camera Control

You can access via a web browser on devices such as a smartphone, tablet terminal, or PC to remotely control the camera.

(☞ P161 [Camera Control Function **200**])

Live streaming

By combining with the decoder or PC application that supports live streaming, you can perform audio and video streaming via the network.

(☞ P167 [Performing Live Streaming **200**])

Preparing Network Connection **200**

Operating Environment

Operation has been verified for the following environments.

Computer

- OS: Windows 7
Web browser: Internet Explorer 11
- OS: Mac OSX 10.9
Web browser: Safari 7

Smartphone/Tablet Terminal

- OS: iOS8 (iPhone 5)
Web browser: Safari 7
- OS: iOS8 (iPad 3rd generation)
Web browser: Safari 7
- OS: Android 4 (Nexus 7 2013)
Web browser: Chrome
- OS: Windows 8.1 (Surface)
Web browser: Internet Explorer 11

Camera Setup for Network Connection

1 Connect an appropriate adapter according to the intended use to the [HOST] terminal at the side terminal section of the camera recorder.

The following adapters can be connected.

- Wireless LAN adapter
- Ethernet adapter
- Cellular adapter

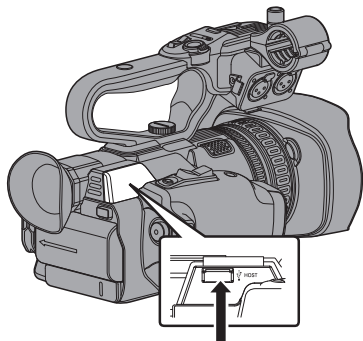

Connect an appropriate adapter

Memo : _____

- Only a network connection adapter can be connected to the [HOST] terminal.
- Connect or disconnect an adapter only after you have turned off the power of the camera recorder.
- You can find the latest information on the compatible adapters at the product page of our website.
- Two types of network coverage (WAN and LAN) are available for each application.

2 Enable the network connection.

Set [Main Menu] → [System] → [Network] to "On".

3 Configure the connection settings.

- Select [Main Menu] → [System] → [Network]/[Settings] → [Connection Setup] → [Wizard] and press the Set button (●).
- A wizard screen appears according to the type of adapter connected. Follow the instructions on the screen to perform setting.
(☞ P143 [Connecting via Wireless LAN])
(☞ P145 [Connecting via Wired LAN])
(☞ P145 [Connecting via Cellular Adapter])

Connecting via Wireless LAN

Connection via Access Point

1 Perform setting on the camera recorder, and start up the [Wizard] screen.

(☞ P143 [Camera Setup for Network Connection])

2 [Wireless LAN] appears on the [Wizard] screen.

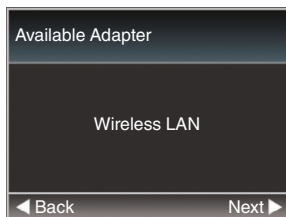

3 Press the ► button to display the [Select Connection Type] screen.

Select "Connect with Access Point".

Follow the screen instructions to complete setting. Perform setting for the following.

- Mode of connection
- Method of setting
 - * SSID, type of encryption, Passphrase, and IP Address setting ("DHCP" or "Manual") in cases other than WPS

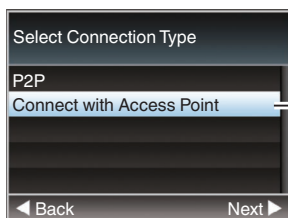

4 Setting is complete.

After setting is complete, you can access the camera recorder via a web browser.

(☞ P150 [Connecting from a Web Browser 200])

P2P Connection

You can access the web function of this camera recorder from devices such as a smartphone, tablet terminal, or PC.

1 [Wireless LAN] appears on the [Wizard] screen.



2 Press the ► button to display the [Select Connection Type] screen.

Select "P2P".

Follow the screen instructions to complete setting.

Perform setting for the following.

- Mode of connection
- Method of setting
 - * SSID and Passphrase in cases other than WPS

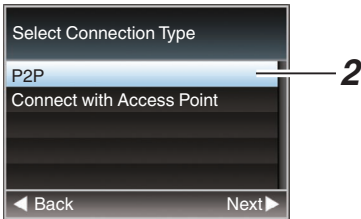

Memo : _____

- When "WPS" is selected in the [Select Setup Type] screen, the following steps 3 and 4 are not required.

3 Set the camera recorder to the Camera mode, and display the [Network] (status) screen.

- Press the [STATUS] button on the camera recorder to display the status screen. Press the cross-shaped button (◀▶) to display the [Network] screen.
- Check to ensure that the [SSID] and [Passphrase] that you have set in the wizard are displayed.

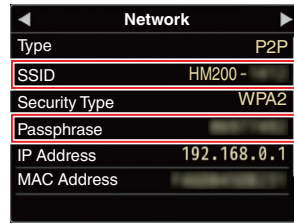

4 Select [SSID] from the list of access points (smartphone, tablet terminal, PC, etc.), and enter [Passphrase].

- Display the list of access points in the wireless connection settings of the smartphone, tablet terminal, or PC, and select "HM200-*****". (***** are numbers that vary with the device used.)
- After the password confirmation screen appears, enter the [Passphrase] displayed on the [Network] screen.

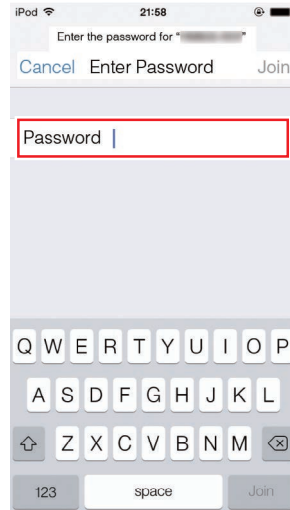

5 Setting is complete.

After setting is complete, you can access the camera recorder via a web browser.

(P150 [Connecting from a Web Browser 200])

Connecting via Wired LAN

You can connect a device such as a smartphone, tablet terminal, or PC directly to the camera recorder using a cross cable to access the camera recorder's web functions. Alternatively, you can also connect using an Ethernet hub.

- 1 **Connect the [HOST] terminal on the camera recorder to the smartphone, tablet terminal, PC, etc. using a cross cable.**
- 2 **Perform setting on the camera recorder, and start up the [Wizard] screen.**
(☞ P143 [Camera Setup for Network Connection])
- 3 **[Ethernet] appears on the [Wizard] screen.**

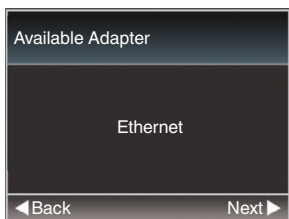

- 4 **Press the ► button to display the [IP Address Configuration] screen.**
Follow the screen instructions to complete setting. Perform setting for the following.
 - IP address setting (DHCP or manual)
 - IP Address
 - Subnet Mask
 - Gateway
 - DNS Server

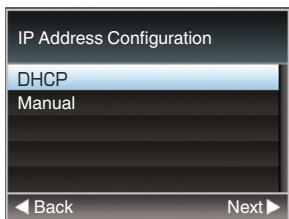

- 5 **Setting is complete.**
After setting is complete, you can access the camera recorder via a web browser.
(☞ P150 [Connecting from a Web Browser 200])

Connecting via Cellular Adapter

You can make use of the FTP function and live streaming function by connecting a cellular adapter to this camera recorder.

- 1 **Connect the cellular adapter to the [HOST] terminal of the camera recorder.**
- 2 **Perform setting on the camera recorder, and start up the [Wizard] screen.**
(☞ P143 [Camera Setup for Network Connection])
- 3 **[Cellular] appears on the [Wizard] screen.**

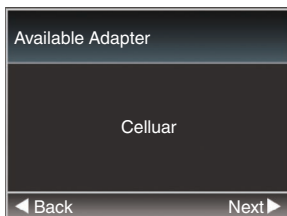

- 4 **Press the ► button.**
Follow the screen instructions to complete setting. Perform setting for the following.
 - Connection phone number
 - User name
 - Password

- Caution : _____
- You can access the web functions via a web browser on devices such as a smartphone, tablet terminal, or PC only in a LAN environment.
 - Note that you may have to pay very high bills in the case of pay-per-use contracts. Fixed price contract is recommended if you are using the network function.
 - Note that the use of improper settings may result in expensive bills from the phone service provider. Make sure that the setting is correct.
 - To avoid expensive bills due to the roaming connection, you are recommended to use this function by disabling the roaming contract.
 - There may be communication even when you are not using the network function. Remove the cellular adapter when the function is not in use.

Importing Metadata 200

You can download a metadata settings file (XML format) from the FTP server and store metadata in the camera recorder. The imported metadata is applied to clips to be recorded.

Preparing Metadata

- You can record the four metadata types below.
 - Title1 : ASCII only, max. 63 characters (bytes)
 - Title2 : UNICODE, max. 127 bytes
 - Creator : UNICODE, max. 127 bytes
 - Description : UNICODE, max. 2047 bytes
- Metadata makes use of the XML description format.
- Edit the <Title1><Title2><Description><Creator> tag element using the XML editor. (Indicated by the frames below)

```
<?xml version="1.0" encoding="UTF-8"?>
<NRT-MetaInterface lastUpdate="2012-07-26T18:06:21+09:00"
xmlns="urn:schemas-proHD:nonRealTimeMetaInterface:ver.1.00"
xmlns: xsi="http://www.w3.org/2001/XMLSchema-instance">
  <MetaData>
    <Title1>Title1 sample</Title1>
    <!-- only "en", max63bytes -->
    <Title2>Title2 sample</Title2>
    <!-- ,max127bytes -->
    <Description>Description sample</Description>
    <!-- ,max2047bytes -->
    <Creator>Creator sample</Creator>
    <!-- ,max127bytes -->
  </MetaData>
</NRT-MetaInterface>
```

Configuring the Server for Downloading

For specifying the settings for connecting to the FTP server for downloading the metadata (domain name, user name, password, etc.) as well as the path of the file to download.

- Open the [Metadata Server] screen.**
Open the [Main Menu] → [System] → [Network]/[Settings] → [Metadata Server] screen.

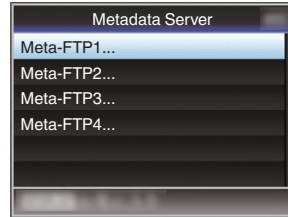

- Register the [Metadata Server].**
 - Select a server using the cross-shaped button (▲▼), and press the Set button (●). The server settings screen appears. Perform setting for each item.
 - Up to 4 settings can be registered. (P121 [Metadata Server])

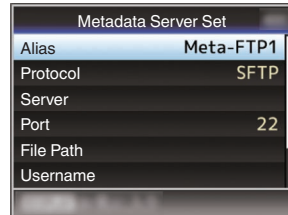

Memo : _____

- For details on the registered information, please consult the network administrator for the server.

Importing Metadata

Download the metadata settings file (XML format) from the FTP server.

- 1 Select [Main Menu] → [System] → [Network] → [Import Metadata] and press the Set button (●).

The [Import Metadata] screen appears.

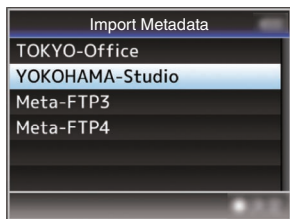

- 2 Select the server for importing the metadata.

- The name that is registered in [Metadata Server] → [Alias] is displayed.
- Select a server using the cross-shaped button (▲▼), and press the Set button (●).

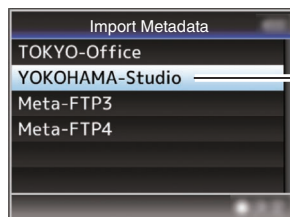

- 3 Select [Import] on the confirmation screen, and press the Set button (●).

Import starts.

After import is complete, the display is restored to the screen before the [Import Metadata] screen appears.

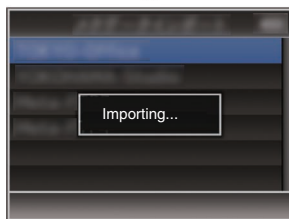
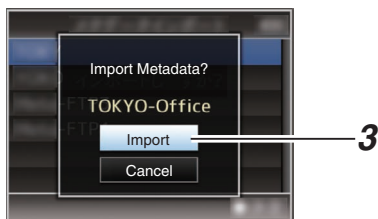

Memo :

- You cannot exit the menu or perform recording while import is in progress.
- If import of the metadata failed, "Import Error!" is displayed, and a message indicating the cause of the error appears. Press the Set button (●) to return to the [Import Metadata] screen in step 1.
(P171 [List of FTP Transfer Errors 200])
- When "HTTP" is selected in the [Select FTP Proxy] screen of the network connection setting, connections to the servers other than "FTP" protocol cannot be made.
- If a setting other than "FTP" is specified for [Protocol], to ensure the safety of the communication path, a screen appears prompting you to validate the fingerprint of the public key and certificate received from the server. Check to ensure that the displayed value coincides with the known value.

Uploading a Recorded Video Clip 200

Upload clips recorded in the SD card to a preset FTP server.

Configuring the FTP Server for Uploading

For specifying the settings for connecting to the FTP server to upload recorded clips to (domain name, user name, password, etc.) as well as the directory of the upload destination.

1 Open the [Clip Server] screen.

Open the [Main Menu] → [System] → [Network]/[Settings] → [Clip Server] screen.

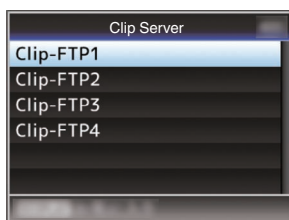

2 Register the [Clip Server].

Register the server to upload recorded clips in the SD card to.

Up to 4 servers can be registered.

(☞ P122 [Clip Server])

Memo : _____

- For details on the registered information, please consult the network administrator for the server.

Uploading Video Clip

Upload clips recorded in the SD card to a preset FTP server.

All playable clips on the thumbnail screen can be uploaded.

Uploading a Video Clip

1 Set the camera recorder to the Media mode.

- Press and hold the [MODE] selection button in Camera mode to enter Media mode. A thumbnail screen of the clips recorded on the SD card is displayed.
- You can upload the selected clips on the thumbnail screen to the FTP server.
(☞ P83 [Thumbnail Screen])

- #### 2 Move the cursor to the clip to be uploaded.
- Move the cursor to the clip to be uploaded using the cross-shaped button (▲▼◀▶).

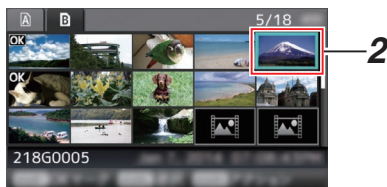

3 Press the [ZEBRA/5] button.

The action selection screen is displayed.

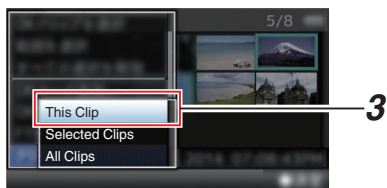

4 Select [FTP Upload] → [This Clip] → server to upload to, and press the Set button (●).

The status of the transfer process is indicated by a progress bar.

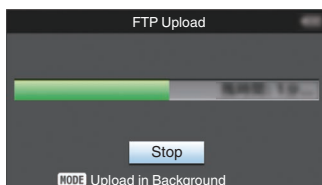

Memo : _____

- The name for the server to upload files to are indicated using the preset names in [Clip Server] → [Alias].
- To stop uploading, press the Set button (●). Select [Yes] on the confirmation screen, and press the Set button (●) to stop uploading and return to the thumbnail screen.

5 Upload is complete.

- After upload is complete, “Successfully Completed.” appears on the screen.
- Press the Set button (●) to return to the thumbnail screen.

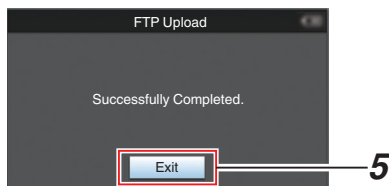

Selecting and Uploading Multiple Clips

To select and upload multiple clips, refer to “[Selecting and Performing Operations on Multiple Clips]” (P 89).

Uploading All Video Clips

1 Press the [ZEBRA/5] button.

The action selection screen is displayed.

2 Upload the clips.

Select [FTP Upload...] → [All Clips] → server to upload to, and press the Set button (●).

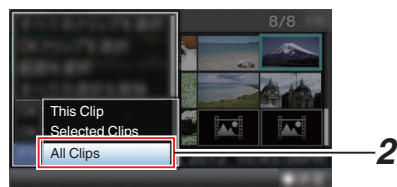

3 Upload starts.

The status of the transfer process is indicated by a progress bar.

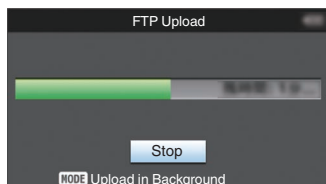

Memo : _____

- To stop uploading, press the Set button (●). Select [Yes] on the confirmation screen, and press the Set button (●) to stop uploading and return to the thumbnail screen.
- If the file to be uploaded has the same name as an existing file in the FTP server, an overwrite confirmation window appears.
- When “HTTP” is selected in the [Select FTP Proxy] screen of the network connection setting, the overwrite confirmation window will not be displayed and the existing file is overwritten.
- Even after upload has started (FTP transfer in progress) in step 3, pressing the [MODE] button switches the camera recorder to the Camera mode, allowing you to start shooting.
- If a setting other than “FTP” is specified for [Protocol], to ensure the safety of the communication path, a screen appears prompting you to validate the fingerprint of the public key and certificate received from the server.

Check to ensure that the displayed value coincides with the known value.

- Fingerprint is a unique value that varies with each public key and certificate.
- For details of the fingerprint, please consult the administrator of the server to be connected.

(P122 [Clip Server])

- When “HTTP” is selected in the [Select FTP Proxy] screen of the network connection setting, connections to the servers other than “FTP” protocol cannot be made.

4 Upload is complete.

- After all clips are uploaded successfully, “Successfully Completed.” is displayed. Press the Set button (●) to return to the thumbnail screen.
- When clips are not uploaded successfully, the following errors are displayed.

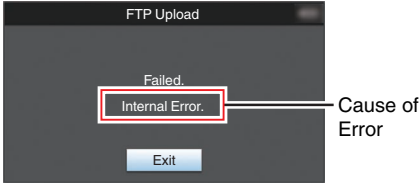

(☞ P171 [List of FTP Transfer Errors 200])

Memo : _____

- If there is an error message or other notifications when you switched to the Camera mode while FTP upload is in progress, a 🗨 icon (yellow) will appear in the remaining media space display area in the Camera mode. You can press the [MODE] button to switch to the Media mode and display the above error screen. Follow “[List of FTP Transfer Errors 200] (☞ P 171)” to clear the error display.

Connecting from a Web Browser 200

You can access the web functions of this camera recorder via a web browser on devices such as a smartphone, tablet terminal, or PC.

Make the necessary preparations for connection in advance.

(☞ P143 [Connect an appropriate adapter according to the intended use to the [HOST] terminal at the side terminal section of the camera recorder.])

1 Set the camera recorder to the Camera mode, and display the [Network] (status) screen.

- Press the [STATUS] button on the camera recorder to display the status screen. Press the cross-shaped button (◀▶) to display the [Network] screen.
- Check the displayed [IP Address].

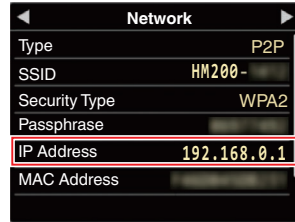

2 Start up the web browser on the terminal you wish to connect to the camera recorder, and enter the [IP Address] in the address field.

(Example: 192.168.0.1)

If “192.168.0.1” is displayed in [IP Address], enter “http://192.168.0.1”.



- 3 **Enter the user name and password.**
 Enter the user name (jvc) and the password (initial password: 0000) on the login screen to display the main page of the camera.

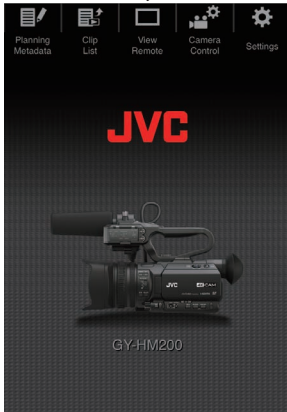
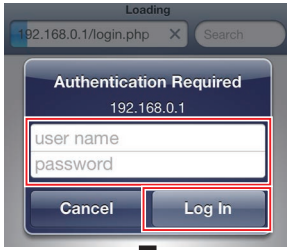

- Memo : _____
- The password can be altered in [Main Menu] → [System] → [Network]/[Settings] → [Web] → [Change Password].
 (P118 [Login Password])

Editing Metadata **200**

You can create the metadata to be inserted into a recorded file, or rewrite the metadata of a recorded clip.

Planning Metadata

You can access the page for editing the camera recorder's metadata via a web browser on devices such as a smartphone, tablet terminal, or PC, and edit the metadata that is to be applied to clips to be recorded.

- 1 **Access the main page of the camera.**
 Access the page via a web browser on devices such as a smartphone, tablet terminal, or PC. (P150 [Connecting from a Web Browser **200**])
- 2 **Tap (click) the [Planning Metadata] tab to open the [Planning Metadata] screen.**



3 Editing Metadata

- 1 Enter information for the necessary fields.
- 2 After input is complete, tap (click) [Save] to overwrite the metadata.

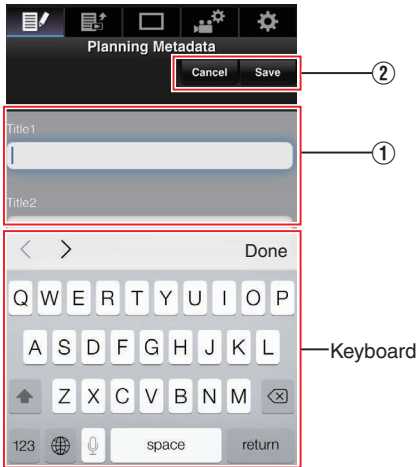

4 Tap (click) [OK] on the confirmation screen.

- Update of the [Planning Metadata] starts.
- After update is complete, “Renewal of planning metadata is succeeded.” is displayed. Tap (click) [OK].
- Returns to the screen in step 3.

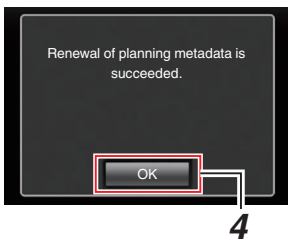

Memo : _____

- If update failed, “Renewal of planning metadata is failed.” is displayed.
Tap (click) [Close] to return to the screen of step 3.
- _____

Clip Metadata

You can access the page for editing the metadata via a web browser on devices such as a smartphone, tablet terminal, or PC, and display or rewrite the metadata that is recorded to a clip.

1 Access the main page of the camera.

Access the page via a web browser on devices such as a smartphone, tablet terminal, or PC. (P150 [Connecting from a Web Browser 200])

2 Display the clip list.

Tap (click) the [Clip List] tab to display the clip list.

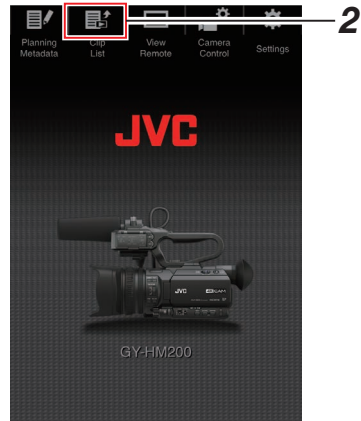

3 Set the camera recorder to the “Remote Edit Mode”.

You can switch to “Remote Edit Mode” from a web browser or through operation of the camera.

■ Switching from a web browser

- ① You will see a message indicating "It is necessary to change the camera mode to "Remote Edit Mode". Change the mode." on the web browser.

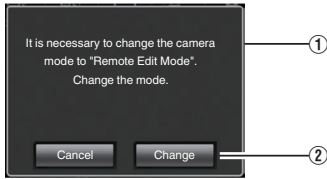

- ② Tap (click) [Change] to switch the camera to the Remote Edit mode.

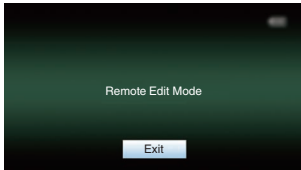

■ Switching from the camera

- ① "Change to Remote Edit Mode?" is displayed on the display screen of the camera unit.
- ② Select [Change] and press the Set button (●) to switch to the Remote Edit mode.

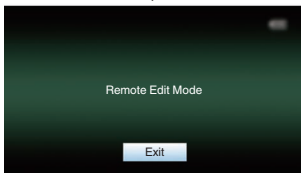
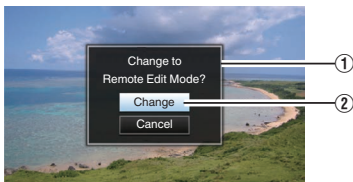

Memo : _____

- When the menu or status is displayed, display of the confirmation screen will be put on hold.
- If the menu is displayed on the camera recorder, close the menu.
- If the status is displayed on the camera recorder, close the status display.
- Pressing the Set button (●) on the camera recorder while in the Remote Edit Mode ends the Remote Edit Mode forcibly and switches to the Camera mode.
- When FTP upload via the camera unit is currently in progress, switching to the Remote Edit mode is disabled.

4 Select the Metadata Edit mode.

Select the [Metadata] tab.

5 Select the clip to rewrite the metadata.

- A list of the recorded clips appears on the [Clip List] screen.
- Tap (click) the clip for which you want to rewrite the metadata.

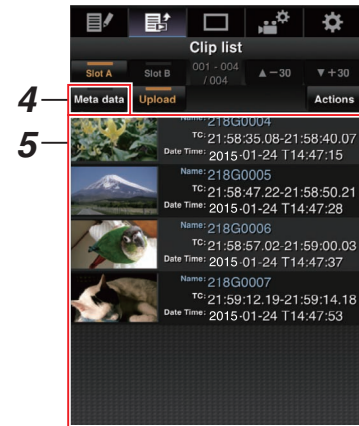

Memo : _____

- You can switch the displayed slot using the [Slot A] and [Slot B] tabs.
- You can use the [▲-30] or [▼+30] tab to jump to the previous or next 30 clips on the list.

6 Editing the Metadata of Selected Clips

- ① Edit the information for the necessary fields.
 - If you are using a PC, input using the mouse and keyboard.
 - If you are using a smartphone or tablet terminal, tap the text input area to display a standard software keyboard on the screen. Enter the information using the displayed keyboard.
- ② You can tap (click) [OK Mark] to add an OK mark to or delete it from selected clips.
- ③ After editing is complete, tap (click) [Save] to overwrite the metadata.

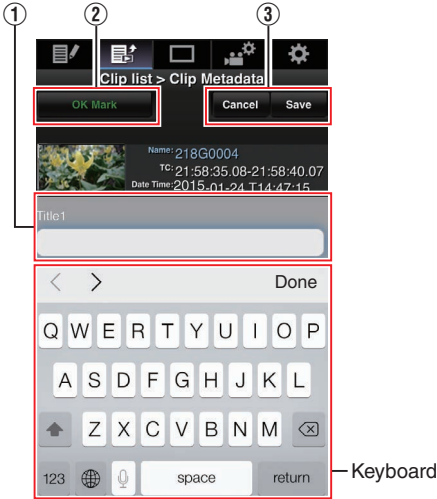

7 Tap (click) [OK] on the confirmation screen.

- Update of the metadata starts.
- After update is complete, “Renewal of clip metadata is succeeded.” is displayed. Tap (click) [OK].
- Returns to the screen in step 4.

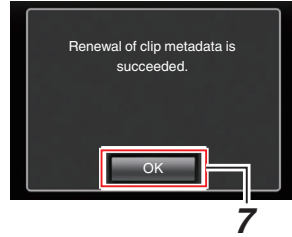

Memo : _____

- If update failed, “Renewal of clip metadata is failed.” is displayed. Tap (click) [Close] to return to the screen of step 4.
- _____

Uploading a Recording Clip via a Web Browser

200

- Upload clips recorded in the SD card to a preset FTP server.
- You can upload selected clips, all clips, or those appended with an OK mark.

Configuring the FTP Server for Uploading

(P148 [Configuring the FTP Server for Uploading])

Uploading Video Clips

- 1 Access the main page of the camera.**
Access the page via a web browser on devices such as a smartphone, tablet terminal, or PC.
(P150 [Connecting from a Web Browser 200])
- 2 Display the clip list.**
Tap (click) the [Clip List] tab to display the clip list.

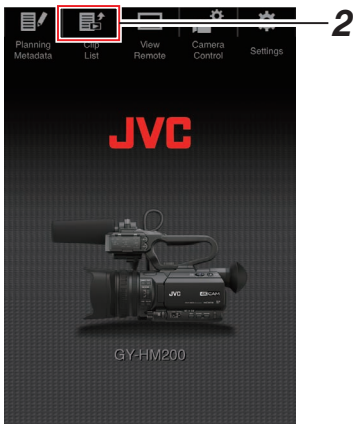

- 3 Set the camera recorder to the "Remote Edit Mode".**
You can switch to "Remote Edit Mode" from a web browser or through operation of the camera.

Switching from a web browser

- ① You will see a message indicating "It is necessary to change the camera mode to "Remote Edit Mode". Change the mode." on the web browser.

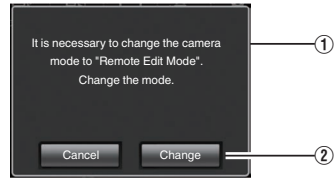

- ② Tap (click) [Change] to switch the camera to the Remote Edit mode.

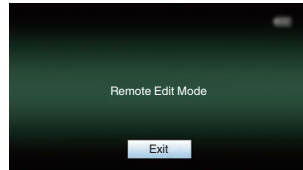

Switching from the camera

- ① "Change to Remote Edit Mode?" is displayed on the display screen of the camera unit.
- ② Select [Change] and press the Set button (●) to switch to the Remote Edit mode.

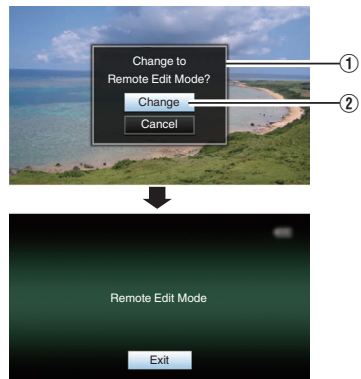

Memo : _____

- When the menu or status is displayed, display of the confirmation screen will be put on hold.
- If the menu is displayed on the camera recorder, close the menu.
- If the status is displayed on the camera recorder, close the status display.
- Pressing the Set button (●) on the camera recorder while in the Remote Edit Mode ends the Remote Edit Mode forcibly and switches to the Camera mode.
- When FTP upload via the camera unit is currently in progress, switching to the Remote Edit mode is disabled.

4 Select the Upload mode.

Select the [Upload] tab.

5 Select the clip you want to upload.

- A list of the recorded clips appears on the [Clip List] screen.
- Tap (click) the clip you want to upload to select it.
- Clips being selected are indicated by a check mark.

Memo : _____

- You can switch the displayed slot using the [Slot A] and [Slot B] tabs.
- You can use the [▲-30] or [▼+30] tab to jump to the previous or next 30 clips on the list.

6 Select the upload operation.

Tap (click) the [Actions] button.

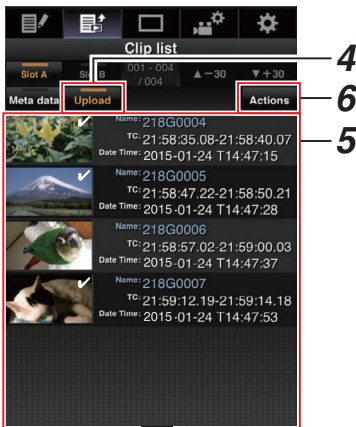

7 Select a method to upload the clips.

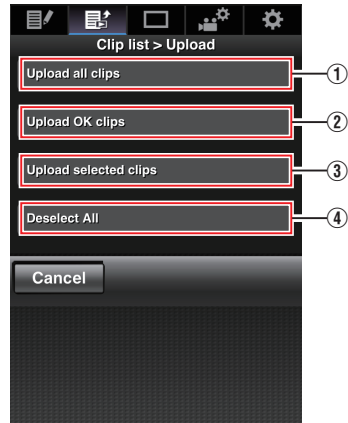

① Upload all clips

Uploads all the clips in the displayed slots. Tap (click) to move to the [Clip Server] screen.

② Upload OK clips

Uploads all clips in the displayed slots that are appended with an OK mark. Tap (click) to move to the [Clip Server] screen.

③ Upload selected clips

Uploads the clips you have selected. Tap (click) to move to the [Clip Server] screen.

④ Clear all selection

Clears all clip selection and returns to the [Clip List] screen.

8 Select the clip server and start uploading.

- Upon selecting the server to upload clips to, an upload screen appears.

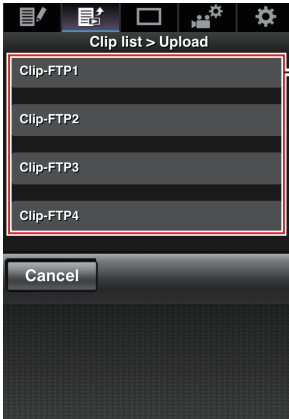

- The status of the transfer process is indicated by a progress bar.

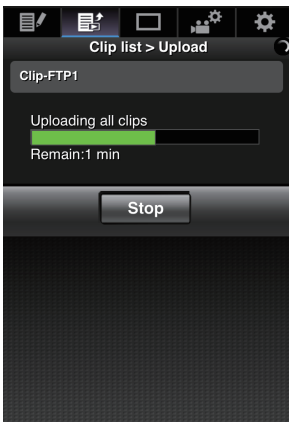

Memo : _____

- To stop transfer, tap (click) the [Stop] button. Tapping (clicking) [Yes] on the confirmation screen stops the transfer halfway and brings you back to the main page.
- If there already exists a file on the FTP server with a name identical to the file to be transferred, a confirmation screen asking to overwrite the file will appear. However, if "HTTP" is selected in the [Select FTP Proxy] screen of the network connection settings, an overwrite confirmation screen does not appear, and the existing file will be overwritten directly.
- After uploading in step 8 has started, other web browser operations are disabled until uploading is complete.
- After uploading in step 8 has started and upon shifting to the Media mode by pressing the [MODE] selection button, operation from the web browser will be disabled. To enable web browser operation, press the [MODE] selection button again to switch to the Camera mode.
- If a setting other than "FTP" is specified for [Protocol], to ensure the safety of the communication path, a screen appears prompting you to validate the fingerprint of the public key and certificate received from the server. Check to ensure that the displayed value coincides with the known value.
 - Fingerprint is a unique value that varies with each public key and certificate.
 - For details of the fingerprint, please consult the administrator of the server to be connected.
(P122 [Clip Server])
- When "HTTP" is selected in the [Select FTP Proxy] screen of the network connection setting, connections to the servers other than "FTP" protocol cannot be made.

9 Upload is complete.

- After upload is complete, "Successfully Completed." appears on the screen.



- When clips are not uploaded successfully, the following errors are displayed.

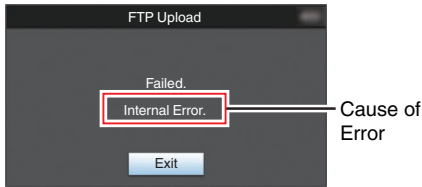

(☞ P171 [List of FTP Transfer Errors 200])

Memo : _____

- Follow "[List of FTP Transfer Errors 200] (☞ P 171)" to clear the error message.

View Remote Feature 200

You can access via a web browser on devices such as a smartphone, tablet terminal, or PC to check the live image and perform the following remote control operations.

- Start/stop recording
- Zooming
- Register/delete preset zoom

1 Access the main page of the camera.

Access the page via a web browser on devices such as a smartphone, tablet terminal, or PC. (☞ P150 [Connecting from a Web Browser 200])

2 Tap (click) the [View Remote] tab to open the [View Remote] screen.

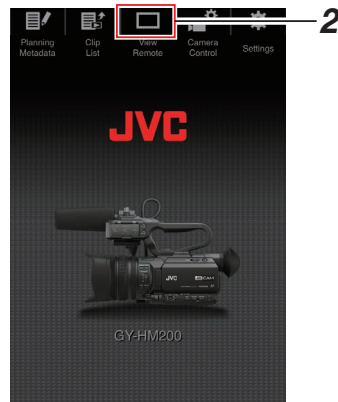

Operating Procedure

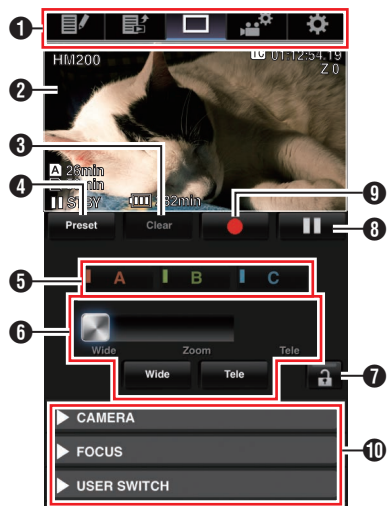

- 1 **Page Switch Tab**
Tap (click) this tab to move to the [Planning Metadata], [Clip Metadata], or [Settings] screen.
- 2 **Live View Screen**
Displays the live images.
Tap a live image to display or hide information that is displayed on the live image, such as remaining space on the media and time code.
- 3 **[Clear] Button**
Switches to the Delete Preset Zoom Position mode.
(☞ P159 [Registering/Deleting Preset Zoom])
(☞ P160 [Deleting a Preset Zoom])
- 4 **[Preset] Button**
Switches to the Register Preset Zoom Position mode.
(☞ P159 [Registering Preset Zoom])
- 5 **[A]/[B]/[C] Buttons**
Use these buttons to perform preset registration or delete a preset data.
- 6 **Zoom Control**
 - Operate the zoom function by dragging the zoom button along the sliding bar.
 - Tap (click) the [Wide] or [Tele] button to fine-tune the zoom position.
 - The slide changes according to the dynamic zoom.
(☞ P97 [Dynamic Zoom])
Dynamic Zoom Off:

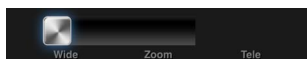

Dynamic Zoom On:

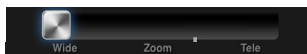

- 7 **Function Lock Button**
Locks the functions that have been set on the [Settings] screen.
(☞ P163 [Changing View Remote Function Settings])

Icon	Description
	Locked
	Not locked

- 8 **Stop Record Button**
- 9 **Start Record Button**
- 10 **Camera Control Function**
(☞ P161 [Camera Control Function 200])

Registering/Deleting Preset Zoom

Registering Preset Zoom

You can register any 3 zoom positions.

- 1 **Set to the Register Preset Zoom mode.**
Tap (click) the [Preset] button to switch to the Register Preset Zoom mode.

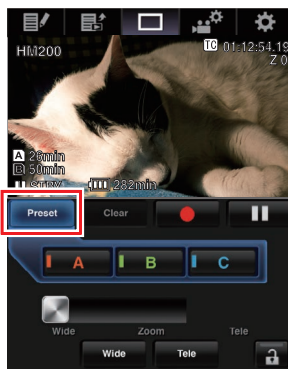

- 2 **Determine the zoom position.**
Use the zoom control to operate the zoom and determine a position.
- 3 **Tap (click) [A].**
Position [A] is registered, and position A is displayed on the sliding bar of the zoom control.



4 In the same way, register [B] and [C].

After all three positions A, B and C are registered, the positions of the [A], [B], and [C] buttons will be rearranged according to the order of the registered zoom position from the left.

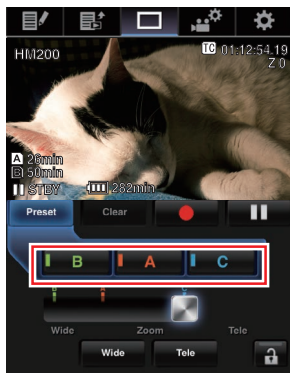

5 Exit the Register Preset Zoom mode.

Tap (click) the [Preset] button to exit the Register Preset Zoom mode.

Memo :

- After registration is complete ([A], [B], and [C] buttons are all active), tapping (clicking) each button switches to the corresponding preset zoom position.
- This function operates independently of the preset zoom position on the camera recorder. (P50 [Saving/Recalling Current Zoom Position (Preset Zoom)])
- When the dynamic zoom is on, the preset button where the dynamic zoom position is registered grays out when the dynamic zoom is off and the zoom position cannot be changed.
- When the dynamic zoom is off, the dynamic zoom position cannot be registered.

Deleting a Preset Zoom

1 Set to the Delete Preset Zoom mode.

When any of positions [A], [B], and [C] are registered, tapping (clicking) the [Clear] button switches to the Delete Preset Zoom mode.



2 Tap (click) the [A], [B], or [C] button that corresponds to the position you want to delete.

- The position is deleted, and the button is grayed out.
- The corresponding zoom position mark on the sliding bar also disappears.

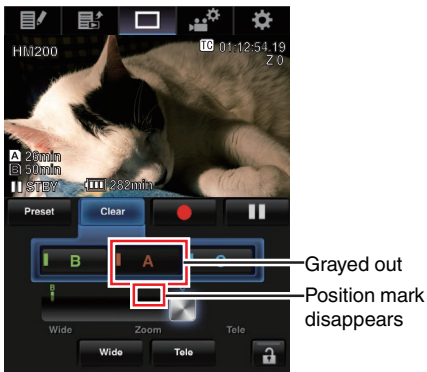

3 Exit the Delete Preset Zoom mode.

Tap (click) the [Clear] button to exit the Delete Preset Zoom mode.

Memo :

- The Clip Review function of the camera recorder is unavailable during View Remote operation. (P73 [Viewing Recorded Videos Immediately (Clip Review)])

Camera Control Function

200

You can control the camera by accessing via a web browser on devices such as a smartphone, tablet terminal, or PC.

You can perform the following operations for each of the items.



1 REC

For performing recording start or recording pause operation.



2 CAMERA

Enables operations related to the camera functions.

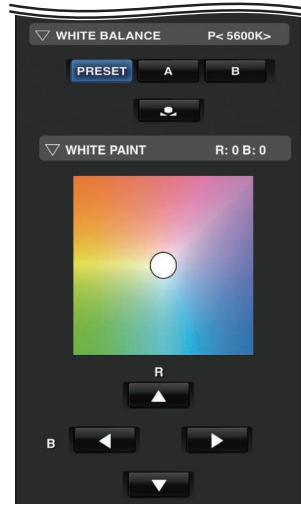
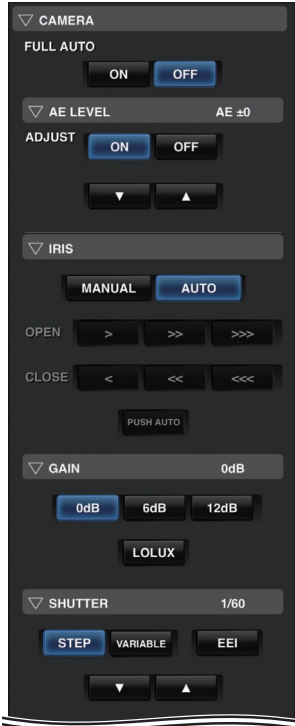

3 ZOOM

Enables zooming operations.

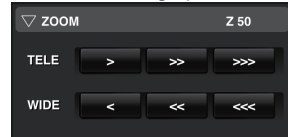

- 4 FOCUS**
Enables focusing operations.



- 5 USER SWITCH**
You can enable or disable the user buttons that are assigned with a function.

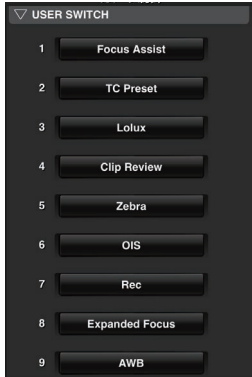

- 6 MENU**
You can show or hide the display and menu characters on an external monitor as well as operation of menus, switching the display screen and status display.



Configuring Settings via a Browser **200**

You can change the network-related settings by accessing via a web browser on devices such as a smartphone, tablet terminal, or PC.

- 1 Access the main page of the camera.**
Access the page via a web browser on devices such as a smartphone, tablet terminal, or PC. (P150 [Connecting from a Web Browser **200**])
- 2 Tap (click) the [Settings] tab.**



- 3 The [Settings] screen appears.**
Set each of the items as follows.

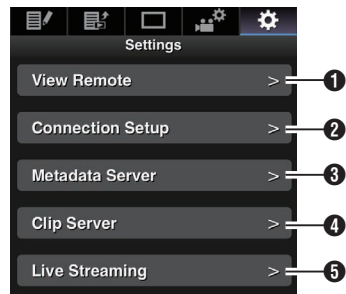

- 1 View Remote
Settings for operations on the View Remote.
- 2 Connection Setup
Settings related to the network.
You can change the settings for each of the preset items on the [Wizard] screen of the camera recorder.
- 3 Metadata Server
Settings on the server for importing the metadata.
Setting can be performed in the same way as the Metadata Server menu on the camera recorder.
The latest settings are reflected, regardless of whether they are specified via the camera recorder or web operation.
- 4 Clip Server
Settings for the server to upload recorded clips to.
Setting can be performed in the same way as the [Clip Server] menu on the camera recorder.
The latest settings are reflected, regardless of whether they are specified via the camera recorder or web operation.
- 5 Live Streaming
Setting for streaming audio and video via the network.
The latest settings are reflected, regardless of whether they are specified via the camera recorder or web operation.

Memo : _____

- Priority is given to menu operation on the camera recorder.
- When the menu on the camera recorder is opened while the [Settings] screen is opened using a web browser, a warning appears, after which the display returns to the main screen.
- While the menu is displayed on the camera recorder, the [Settings] screen cannot be opened via the web browser.

Changing View Remote Function Settings

For performing setting for using the View Remote function.

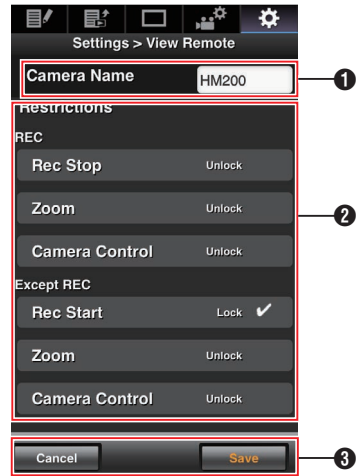

- 1 [Camera Name]
 - For setting the name that appears at the top left of the view screen.
 - Tapping the text input area displays a software keyboard.
If you are using a PC, enter using the PC keyboard.
 - By tapping the Go key after input is complete, the software keyboard disappears.
- 2 [Restrictions]

For setting the buttons to be disabled on the View screen while in the locked mode.

 - [REC]:
For setting whether to disable the Stop Record button, zoom operation, and camera control during recording.
Tap (click) each item to switch between [Unlock] and [Lock].
 - [Except REC]:
For setting whether to disable the record button, zoom operation, and camera control in any mode other than the recording mode.
Tap (click) each item to switch between [Unlock] and [Lock].
- 3 [Save]/[Cancel]

Tap (click) [Save] to save the settings.
Tap (click) [Cancel] to stop setting and return to the main [Settings] screen.

Changing Connection Setup

You can change the settings for each of the preset items on the [Wizard] screen of the camera recorder.

- If all the items cannot be displayed in a single page, scroll down to display the remaining items.
- Items that cannot be changed are grayed out according to the type of adapter connected and the mode of connection.

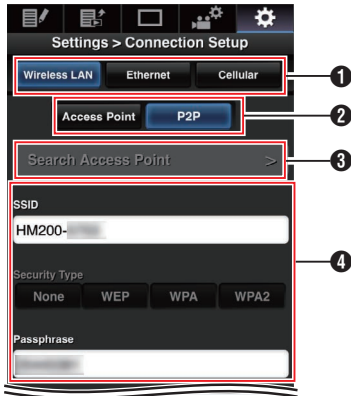

- 1 Type of Adapter Connected
- 2 Mode of Wireless LAN Connection
- 3 [Search Access Point] Button
Tap (click) to display a list of the detected access points.
The currently selected access point is indicated by a dot mark (•).



- 4 Settings on the [Select Setup Type] Screen



- 5 Settings on the [IP Address Configuration] Screen
When "DHCP" is selected, all items will be grayed out.

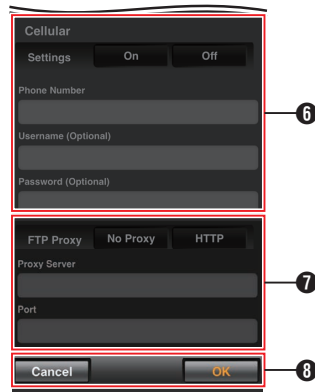

- 6 Settings when using cellular adapter
- 7 Settings on the [Select FTP Proxy] Screen
- 8 [OK]/[Cancel] Button
After changing of settings is complete, tap (click) the [OK] button.
On the confirmation screen, tap (click) [Execute] to change the settings on the camera recorder and restart the network.

Changing Metadata Server Settings

You can make direct changes to the FTP server for importing the metadata set in [Main Menu] → [System] → [Network]/[Settings] → [Metadata Server], as well as the path of the file to import.

(☞ P121 [Metadata Server])

Changing Clip Server Settings

You can make direct changes to the server and directory settings that are specified in [Main Menu] → [System] → [Network]/[Settings] → [Clip Server] for uploading recorded clips in the SD card to the FTP server.

(☞ P122 [Clip Server])

Changing Streaming Settings

You can make direct changes to settings that are specified in [Main Menu] → [System] → [Network]/[Settings] → [Live Streaming Set], such as information on the destination of distribution.

(☞ P118 [Live Streaming Set])

Managing the Network Connection Settings File

200

This camera recorder allows you to save the network connection settings on the Wizard screen to the camera recorder unit.

Loading a saved connecting settings file enables you to reproduce the appropriate network connection state speedily.

Memo : _____

- To save or load the connection settings, go to [Main Menu] → [System] → [Network]/[Settings] → [Connection Setup].
- The following operations can be performed on the [Connection Setup] menu.
 - [Saving the Connection Settings File] (☞ P 165)
 - [Reading the Connection Settings File] (☞ P 166)
 - [Deleting Connection Settings] (☞ P 167)

Number of Storable Setup Files

Camera recorder : [CAM1] to [CAM4]

Saving the Connection Settings File

- 1 Select [Main Menu] → [System] → [Network]/[Settings] → [Connection Setup] and press the Set button (●).
- 2 Select [Store] and press the Set button (●).

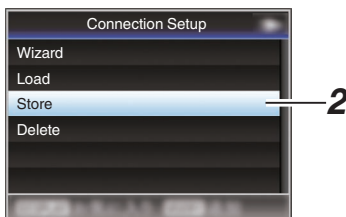

- 3 Select the file to be newly saved (or overwritten) using the cross-shaped button (▲▼), and press the Set button (●).



- 4 Name the file.

Enter the subtitle using the software keyboard.

(☞ P94 [Text Input with Software Keyboard])

Memo : _____

- When overwriting an existing file, the subtitle of the existing file is displayed.
- Select [Cancel] and press the Set button (●), or press the [CANCEL] button to return to the previous screen.

5 Select [Store] and press the Set button (●).



6 Save the file.

- A confirmation screen appears when you choose to overwrite. Select [Overwrite] on the confirmation screen, and press the Set button (●). Saving starts, and “Storing...” appears on the screen.

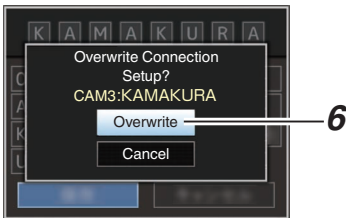

- Saving starts, and “Storing...” appears on the screen when the file is newly saved.



7 Saving is complete.

After saving of the file is complete, “Complete” appears on the screen, and the menu screen closes automatically.

Reading the Connection Settings File

- 1 Select [Main Menu] → [System] → [Network]/[Settings] → [Connection Setup] and press the Set button (●).
- 2 Select [Load] and press the Set button (●).

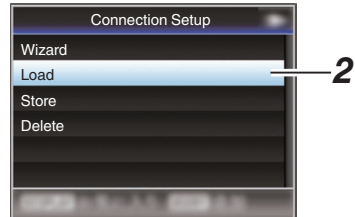

- 3 Select the file to read using the cross-shaped button (▲▼), and press the Set button (●).



- 4 Select [Load] on the confirmation screen, and press the Set button (●).

Loading starts, and “Loading...” appears on the screen.

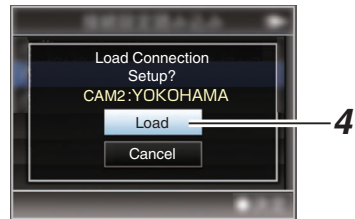

- 5 Reading is complete.

After reading of the file is complete, “Complete” appears on the screen, and the menu screen closes automatically.

Deleting Connection Settings

- 1 Select [Main Menu] → [System] → [Network]/[Settings] → [Connection Setup] and press the Set button (●).
- 2 Select [Delete] and press the Set button (●).

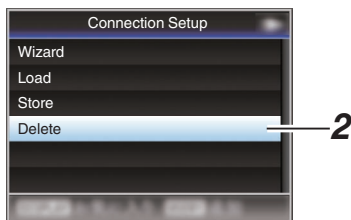

- 3 Select the file to delete using the cross-shaped button (▲▼), and press the Set button (●).



- 4 Select [Delete] on the confirmation screen, and press the Set button (●).
Deletion starts, and "Deleting..." appears on the screen.



- 5 Deletion is complete.
After file deletion is complete, "Complete" appears on the screen.

Performing Live Streaming **200**

By combining with the decoder or PC application that supports live streaming, you can perform audio and video streaming via the network.

Supported Formats

Video

H.264

- 1920x1080 / 60i (12.0 Mbps), 60i (8.0 Mbps), 60i (5.0 Mbps), 60i (3.0 Mbps), 50i (12.0 Mbps), 50i (8.0 Mbps), 50i (5.0 Mbps), 50i (3.0 Mbps)
- 1280x720 / 30p (8.0 Mbps), 30p (5.0 Mbps), 30p (3.0 Mbps), 30p (1.5 Mbps), 25p (8.0 Mbps), 25p (5.0 Mbps), 25p (3.0 Mbps), 25p (1.5 Mbps)
- 720x480 / 60i (8.0 Mbps), 60i (5.0 Mbps), 60i (3.0 Mbps), 60i (1.5 Mbps), 60i (0.8 Mbps), 60i (0.3 Mbps), 60i (0.2 Mbps)
- 720x576 / 50i (8.0 Mbps), 50i (5.0 Mbps), 50i (3.0 Mbps), 50i (1.5 Mbps), 50i (0.8 Mbps), 50i (0.3 Mbps), 50i (0.2 Mbps)
- 480x270 / 30p (0.2 Mbps), 25p (0.2 Mbps)

Memo :

- The following constraints apply depending on the setting of [Main Menu] → [System] → [Network]/[Settings] → [Live Streaming Set] → [Type].
 - An encoding bit rate exceeding 8.0 Mbps cannot be selected when [Type] is set to "RTSP/RTP".
 - An encoding bit rate exceeding 5.0 Mbps cannot be selected when [Type] is set to "ZIXI" and [Latency] is set to other than "Low", or when [Type] is set to "RTMP".
 - An encoding bit rate exceeding 3.0 Mbps cannot be selected when [Type] is set to "ZIXI" and [Latency] is set to "Low".
(☞ P119 [Type])
 - Depending on the type of network adapter used and the connection, the images and audio sound during live streaming can be choppy.

Audio

AAC

Supported Protocols

Network protocols : TCP, UDP
 Transport mode : MPEG2-TS, RTSP/RTP, ZIXI, RTMP

Setting Distribution

1 Set the [Record Format] according to the resolution and frame rate of the video to be distributed.

For details on the [Record Format] settings, please refer to [Combinations of [Record Format] and [Live Streaming Set] that Support Transmission] (P 168).

Memo : _____

- Live streaming cannot be performed in the following cases.
 - [Main Menu] → [System] → [Record Set] → [Record Format] → [System] set to “4K” or “HD+Web”.
 - [Main Menu] → [System] → [Record Set] → [Record Format] → [A]Frame Rate set to “24p”, or [A]Bit Rate set to “50M(YUV422)”.

2 Set the Resolution and Frame & Bit Rate for the video to be distributed.

Specify the settings in [Main Menu] → [System] → [Network]/[Settings] → [Live Streaming Set]. (P118 [Live Streaming Set])

3 Specify the distribution protocol and related items.

Specify the distribution protocol and related items in [Main Menu] → [System] → [Network]/[Settings] → [Live Streaming Set] → [Streaming Server]. (P119 [Streaming Server])

4 Select the server for live streaming.

Select the transmission server in [Main Menu] → [System] → [Network]/[Settings] → [Live Streaming Set] → [Server].

Combinations of [Record Format] and [Live Streaming Set] that Support Transmission

System	Record Format			Live Streaming Set (Resolution, Frame Rate)			
	Resolution	Frame Rate	Bit Rate	1920x1080, 60i/50i	1280x720, 30p/25p	720x480/720x576, 60i/50i	480x270, 30p/25p
4K	-	-	-	X	X	X	X
HD	1920x1080	60p/50p	50M (XHQ)	✓	✓	✓	✓
			50M (YUV422)	X	X	X	X
		60i/50i	50M (XHQ)/35M (UHQ)	✓	X	✓	✓
			50M (YUV422)	X	X	X	X
	30p/25p	50M (XHQ)/35M (UHQ)	✓	✓	✓	✓	
		50M (YUV422)	X	X	X	X	
	24p	-	-	X	X	X	X
1280x720	60p/50p/30p/25p	-	X	✓	✓	✓	
SD	-	-	-	X	X	✓	✓
HD+Web	-	-	-	X	X	X	X

* ✓: Supported; X: Not supported

Starting Distribution

1 Perform the necessary setting for the decoder and PC application.

For details on the settings, please refer to the instruction manual of the respective devices and applications.

Memo : _____

- If there is an NAT router within the communication path between the camera and the decoder, port forwarding setup is required. For details on the settings, please refer to the instruction manual of the router in use.
- The following parameters are required when connecting to this camera recorder using the RTSP/RTP.
 - Port number: 554
 - Stream ID: stream
- Use the following to access via URL.
 - rtsp://<IP address of the camera recorder>:554/stream

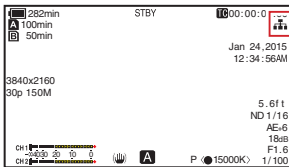

2 With the network connection established, set [Live Streaming] to "On".

- (P142 [Preparing Network Connection 200])
 - Set [Main Menu] → [System] → [Network]/[Settings] → [Live Streaming Set] → [Live Streaming] to "On".
 - The network connection mark appears on the display screen when a network connection is established.



Memo : _____

- You can also assign "Live Streaming" to a user button.
 - (P39 [Assignment of Functions to User Buttons])
- You can view the status of distribution on the LCD monitor.
 - (P131 [Live streaming mark 200])

Icon	Status
 (Red)	Distribution in progress (good connection quality) Blinks when distribution starts or stops
 (Red)	Distribution in progress (poor connection quality)
 (Yellow)	Waiting for connection (during RTSP/RTP) or connection failed

- When the  icon is displayed, you can view the details of the error on the [Network] screen of the status screen.

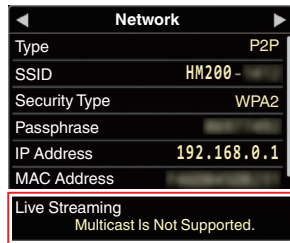

—Cause of Error

(P173 [List of Live Streaming Error Displays 200])

Caution : _____

- Streaming may be interrupted temporarily 24 hours after the process started.

Error Messages and Actions

Warning display on the LCD monitor and viewfinder screen, tally lamp indication and warning tone are as follows according to the error status.

Memo : _____

- This camera recorder makes use of a microcomputer. Noise interference from external sources may prevent it from functioning properly. When this occurs, turn off and on the power of the camera recorder again.

Error Message	Status	Action
Turn Power Off Turn Back On Later	System error. * The warning tone sounds and the tally lamp blinks twice every second.	Turn off the power, and turn it on again. If the error persists, please contact the local dealers in your area.
Fan Stop Detected Please Turn P.Off	<ul style="list-style-type: none"> • The fan stopped running. 	Please contact the local dealers in your area.
Fan Maintenance Required	Usage time of the fan has exceeded 9000 hours.	Check the fan and replace accordingly. For more details, please contact the local dealers in your area. Memo : _____ <ul style="list-style-type: none"> • You can check the usage time of the fan in [System] ➔ [System Information] ➔ [Fan Hour]. (☞ P114 [Fan Hour])
Getting Overheated. Please Turn Power Off.	<ul style="list-style-type: none"> • The battery has exceeded the specified temperature. • The power turns off automatically after about 15 second. 	<ul style="list-style-type: none"> • Wait until the temperature drops or replace the battery. • If the error persists, please contact the local dealers in your area.
Rec Inhibited	[REC] button is pressed when the write-protect switch of the SD card is set.	Turn off the write-protect switch of the SD card, or insert a recordable SD card. (☞ P40 [SD Card])
Lost Media Info *	<ul style="list-style-type: none"> • Card is removed while recording is in progress. • Card is removed while formatting is in progress. • Card is removed while restoring is in progress. • Card is removed while adding the OK mark. • Card is removed while writing a setup file. • Card is removed while deleting a clip. (*: A, B)	Restore the card using this camera recorder. (☞ P43 [Restoring the SD Card])

Error Message	Status	Action
Record Format Incorrect	<ul style="list-style-type: none"> The video format of the file for Clip Review is different from the current [A Resolution], [A Frame Rate], or [A Bit Rate] setting. 	Set [A Resolution], [A Frame Rate] and [A Bit Rate] correctly. (☞ P115 [A Resolution]) (☞ P115 [A Frame Rate]) (☞ P115 [A Bit Rate])
Media Full	<ul style="list-style-type: none"> [REC] button is pressed when the media in use has no remaining space. Remaining space ran out during recording. 	Replace the SD card with a new one.
No Clips	No viewable clips are found on the card for Clip Review.	Insert an SD card that contains clips that can be reviewed. (☞ P40 [SD Card]) (☞ P73 [Viewing Recorded Videos Immediately (Clip Review)]))
No Media	[REC] button is pressed when an SD card is not inserted.	Insert an SD card. (☞ P40 [SD Card])
No Media	No SD card is found in Media mode or when the thumbnail screen is displayed.	Insert an SD card. (☞ P40 [SD Card])
No Clips	No clips are found on the inserted SD card in Media mode or when the thumbnail screen is displayed.	Insert an SD card that contains playable clips. (☞ P40 [SD Card]) (☞ P83 [Playing Recorded Clips])
12h Continuation Record	The continuous recording time in AVCHD mode exceeds 12 hours and recording stops automatically.	To continue recording, press the [REC] button again.

List of FTP Transfer Errors 200

If the upload of a recorded clip or download of the metadata setup file (XML format) is not successfully completed, the following errors are displayed.

Error message	Status	Action
Timeout.	Transfer was discontinued due to timeout caused by network transmission or server failure.	<ul style="list-style-type: none"> Execute again. Use a different server.
Media Was Removed.	SD card is removed while FTP transfer is in progress.	Insert the SD card and execute FTP transfer again.
Adapter Was Removed.	The USB network device is removed while FTP transfer is in progress.	Connect the USB network device.
Cannot Connect to Server.	Unable to connect to the FTP server.	Adjust the Server and Port settings for [Metadata Server] or [Clip Server]. (☞ P121 [Metadata Server]) (☞ P122 [Clip Server])

Error message	Status	Action
Access Denied.	Access is denied.	Adjust the Server and Port settings for [Metadata Server] or [Clip Server]. (☞ P121 [Metadata Server]) (☞ P122 [Clip Server])
Invalid Username or Password.	Authentication for login to the FTP server failed.	Adjust the Username and Password settings for [Metadata Server] or [Clip Server]. (☞ P121 [Metadata Server]) (☞ P122 [Clip Server])
Invalid Path Was Requested.	The path specified for the FTP server is incorrect.	Adjust the [Clip Server] and [Dir. Path] settings for [Metadata Server] or [File Path]. (☞ P121 [Metadata Server]) (☞ P122 [Clip Server])
Server Error.	There was an unintended operation of the FTP server.	Execute again. Use a different server.
Invalid Request.	A bad request is executed for the FTP server.	Execute again.
Invalid Data Size.	Invalid data size, such as a planning metadata size that exceeds 4 KB.	Adjust the planning metadata saved in the [Metadata Server]. (☞ P151 [Planning Metadata])
Invalid Data Format.	The XML format of the planning metadata is invalid.	Adjust the planning metadata saved in the [Metadata Server]. (☞ P151 [Planning Metadata])
Transfer Error.	Transfer failed due to communication failure.	Execute again.
Invalid URL.	The path was deemed invalid by the FTP server.	Adjust the Server and Port settings for [Metadata Server] or [Clip Server]. (☞ P121 [Metadata Server]) (☞ P122 [Clip Server])
Media Access Error.	Reading/writing of the SD card failed while FTP transfer is in progress.	Insert a different SD card.
Internal Error.	An internal error has occurred while FTP transfer is in progress.	Adjust the settings and execute again.
Other Error.	An unknown error or other errors have occurred while FTP transfer is in progress.	Adjust the settings and execute again.
Media Read Error.	Reading of the SD card failed while FTP transfer is in progress.	Insert a different SD card.

List of Live Streaming Error Displays 200

The following error messages are displayed when the live streaming setting is incorrect, or when the connection is lost during live streaming.

Error message	Status	Action
Invalid Address.	<ul style="list-style-type: none"> The IP address format is incorrect. The domain name cannot be converted into the IP address. 	<ul style="list-style-type: none"> Enter the IP address, host name or URL of the destination correctly. (☞ P168 [Setting Distribution])
Multicast Is Not Supported.	An IP multicast address was set.	Use an IP address that is not a multicast address.
Cannot Connect to Receiver.	Establishment of connection with TCP failed.	<ul style="list-style-type: none"> Ensure that the recipient's device is set to TCP. Set Type to "MPEG2-TS/UDP". (☞ P168 [Setting Distribution])
TCP Disconnected.	TCP connection is lost.	Check to ensure that there is no abnormality in the decoder, or network connection device and cables, followed by establishing the connection again.
Not Enough Bandwidth.	<ul style="list-style-type: none"> The communication bandwidth is narrower than the average bit rate. The network bandwidth is insufficient, and packets are discarded. 	<ul style="list-style-type: none"> Lower the resolution/picture quality of the video to be distributed. Consider switching to the use of a stable network, such as wired LAN.
Connection Timeout	Timeout for connection via ZIXI.	Set [Destination Address] and [Destination Port] correctly. (☞ P168 [Setting Distribution])
Authorization Failed	Authentication of connection via ZIXI failed.	Set [Stream ID] and [Password] correctly. (☞ P168 [Setting Distribution])
Connection Error	Connection via "ZIXI" or "RTMP" failed.	<ul style="list-style-type: none"> Check whether a different camera with an identical stream ID is connected. Set [Destination URL] and [Stream Key] correctly. (☞ P119 [Destination URL]) (☞ P119 [Stream Key])
Disconnected	"ZIXI" or "RTMP" connection is lost.	Check whether there is abnormality with the network connection device, cables, etc., and try to re-establish the connection.

Blinking of the Tally Lamp

The tally lamp start blinking when the remaining space on the SD card is running out during recording, or when the battery power is running low.

Blinking Mode	Remaining Battery Power/SD Card Space
Blinks slowly (once every second)	<ul style="list-style-type: none"> Battery power is low Remaining recording time on SD card is less than 3 minutes (during recording) When a malfunction occurred during live streaming 200
Blinks quickly (2 times per second)	<ul style="list-style-type: none"> Remaining battery power is almost zero Remaining recording time on SD card is zero (during recording) Error on the camera recorder

Warning Tone

- Warning tone is output from the monitor speaker and [⏏] terminal when the battery level is low.
- Warning tone is also output when an error occurs in the camera recorder.

Memo :

- You can specify whether to turn on the warning tone as well as setting the volume in [A/V Set] → [Audio Set] → [Alarm Level].
(☞ P112 [Alarm Level])

Troubleshooting

Symptom	Action
Power does not turn on.	<ul style="list-style-type: none"> Is the AC adapter properly connected? Is the battery charged? Is the power turned on immediately after it is turned off? Make sure to wait for an interval of at least 5 seconds before turning on the power again.
Unable to start recording.	<ul style="list-style-type: none"> Is the record trigger button/lock switch on the handle turned on? HDL Is the write-protect switch of the SD card turned on? Make sure that the write-protect switch is turned off. (☞ P40 [Write-Protect Switch on the SD Card]) Is the camera recorder set to the Camera mode? Use the [MODE] selection button to switch to the Camera mode. (☞ P18 [Operation Modes]) Is the SD card inserted compatible with the recording format? (☞ P48 [Selecting a Video Format]) (☞ P117 [4GB File Spanning(SDXC)])
Camera image is not output on the LCD monitor and viewfinder screen.	<ul style="list-style-type: none"> Is the camera recorder set to the Camera mode? Use the [MODE] selection button to switch to the Camera mode. (☞ P18 [Operation Modes])
Playback does not start after selecting a clip thumbnail and pressing the Set button (●).	<ul style="list-style-type: none"> Is the selected clip a playable clip? Playback is not possible if the clip has a different video format setting.
Images on the LCD monitor and viewfinder screen appear dark or blurred.	<ul style="list-style-type: none"> Readjust the brightness of the LCD monitor and viewfinder. Is the [ND FILTER] switch set to "1/16"? Is the iris closed? Is the shutter speed setting too high? Is the amount of peaking too little? Use the [LCD/VF Peaking] menu to adjust the contour for the LCD monitor image and viewfinder image by adjusting the contour of the viewfinder image. (The contour of the LCD monitor will also be adjusted at the same time.) Adjust using [Main Menu] → [LCD/VF] → [LCD/VF Peaking]. (☞ P37 [Adjusting the LCD Monitor]) (☞ P38 [Adjusting the Viewfinder])

Symptom	Action
The [CH1/CH2] recording level adjustment knob does not work. HDL	<ul style="list-style-type: none"> Is the [CH1/CH2 AUTO/MANUAL] switch set to "AUTO"? Is Full Auto enabled? Is [A/V Set] → [Audio Set] → [Audio On FULL AUTO] set to "Auto" in Full Auto mode? (☞ P112 [Audio On FULL AUTO])
SD card cannot be initialized (formatted).	<ul style="list-style-type: none"> Is the write-protect switch of the SD card turned on? Make sure that the write-protect switch is turned off. (☞ P40 [Write-Protect Switch on the SD Card])
Battery alarm appears even after loading a charged battery.	<ul style="list-style-type: none"> Is the battery too old?
The time code and user's bit are not displayed.	<ul style="list-style-type: none"> Even in Camera mode or Media mode, the time code and user's bit may not be displayed depending to the type of display. Is [LCD/VF] → [Display Settings] → [TC/UB] set to "Off"? To display the time code or user's bit, set it to "TC" or "UB". (☞ P107 [TC/UB])
The date and time are not displayed.	<ul style="list-style-type: none"> The date and time are only displayed on the Display 1 and Display 2 screens in the Camera mode (during shooting). (☞ P127 [Display Screen in Camera Mode]) Is [System] → [Record Set] → [Time Stamp] set to "On"? To display the date and time, set it to "Off". (☞ P117 [Time Stamp])
Incorrect display on the viewfinder.	<ul style="list-style-type: none"> Is [LCD/VF] → [VF SW] set to "Enable", and is the viewfinder in use without being pulled out? To use the viewfinder in this setting, pull out the viewfinder. (☞ P104 [VF SW])
The actual recording time is shorter than the estimated time.	<ul style="list-style-type: none"> The recordable time may be shorter depending on the shooting conditions or the subject.
Cannot connect to wireless LAN. 200	<ul style="list-style-type: none"> Check the mode of connection and method of setting ([SSID] and [Passphrase] in cases other than WPS). (☞ P143 [Connecting via Wireless LAN]) Even if the Passphrase is wrong, "Completed the Setup Wizard. Please Input the Passphrase into Your Device." may appear at the browser setting depending on the type of encryption. Adjust [Passphrase] again.
The View Remote screen turns black. The screen flickers. The screen freezes. Cannot perform remote operation. 200	<ul style="list-style-type: none"> The network path is congested. Wait a while before refreshing (reloading) the web browser.
The clips cannot be uploaded to the FTP server. 200	<ul style="list-style-type: none"> Adjust the [Clip Server] settings. (☞ P122 [Clip Server]) The maximum size of the recorded clip is 64 GB. If a file size limit is set in the FTP server settings, set the size limit to more than 64 GB. Take necessary action as described in "[List of FTP Transfer Errors 200] (☞ P 171)".
The wireless LAN is disconnected. 200	<ul style="list-style-type: none"> The wireless LAN may be disconnected depending on the environment. Change the usage environment. Connect via wired LAN. (☞ P145 [Connecting via Wired LAN])
The images and audio sound during live streaming are choppy. 200	<ul style="list-style-type: none"> Depending on the type of network adapter used and the connection, streaming may not be possible with the encoding bit rate specified. Please reduce the encoding bit rate.

Specifications

General

Item	Description
Power	DC 12 V
Power consumption	200 <ul style="list-style-type: none"> • Approx. 7.9 W (*1) • Approx. 7.3 W (*2) 170 <ul style="list-style-type: none"> • Approx. 7.6 W (*1) • Approx. 6.7 W (*2)
Mass	200 <ul style="list-style-type: none"> • Approx. 1.6 kg (with battery) 170 <ul style="list-style-type: none"> • Approx. 1.2 kg (with battery)
Allowable operating temperature	0 °C to 40 °C (32 °F to 104 °F)
Allowable operating humidity	30 %RH to 80 %RH
Allowable storage temperature	-20 °C to 50 °C (-4 °F to 122 °F)
Dimensions (W × H × D)	200 <ul style="list-style-type: none"> • 149 mm × 191 mm × 307 mm (including handle unit) 170 <ul style="list-style-type: none"> • 149 mm × 112 mm × 307 mm

*1 When [System] is set to “4K” and all other settings are in factory default

*2 When [System] is set to “HD” and all other settings are in factory default

Terminal Section

Item	Description
[SDI OUT] terminal (480i or 576i: Downconverted 720p/1080i/1080p: embedded audio), BNC (unbalanced) 200	
3G-SDI	Compliant with SMPTE ST424
HD-SDI	Compliant with SMPTE ST292
SD-SDI	Compliant with SMPTE ST259
[INPUT1/INPUT2] terminal HDL	
[LINE]	+4 dBu, 10 kΩ, XLR (balanced)
[MIC]	-50 dBu, 4 kΩ, XLR (balanced), +48 V output (phantom power supply)
[AUX] terminal	Φ3.5 mm stereo mini jack -22 dBu 10 kΩ
[AV] terminal	Φ3.5 mm 4-pin mini jack
Video signal	1.0 V (p-p)
Audio signal	-8 dBu (during reference level input), 1 kΩ (unbalanced)

Item	Description
[Q] terminal	Φ3.5 mm stereo mini jack
Output	-18 dBu, 16 Ω load (reference level at -20 dBFS, and at maximum headphone volume)
[REMOTE] terminal	Φ2.5 mm stereo mini jack
[Y] terminal	
[DEVICE]	Mini USB-B type, USB 2.0, miniB, slave function (mass storage class) only
[HOST] 200	USB-A type, USB2.0, network connection function only

Lens Section

Item	Description
Lens	F1.2, 12x, f= 4.67 mm to 56.04 mm (35 mm equivalent: 29.6 mm to 355 mm)
Filter diameter	Φ62 mm

Camera Section

Item	Description
Image pickup device	1/2.5-inch Progressive CMOS
Sync system	Internal sync (built-in SSG)
Optical filter	OFF, 1/4, 1/16
Gain	0dB, 3dB, 6dB, 9dB, 12dB, 15dB, 18dB, 21dB, 24dB, Lolux (30dB, 36dB), AGC
Electronic shutter	1/6 to 1/10000, EEI
LCD monitor	3.5-inch LCD, 16:9 920K pixels
Viewfinder	0.24-inch LCOS, 16:9 1.56M pixels (960 x 540 x 3)

Storage Section

Item	Description
Supported media	SDHC/SDXC
Slots	x 2

Video/Audio

Item	Description
Recording time	Approx. 25 minutes (8 GB SD card, 35 Mbps, VBR mode)
4K mode	
Recording file format	QuickTime File Format
Video	MPEG-4 AVC/H.264 150 Mbps (Max) 3840x2160/30p, 25p, 24p
Audio	LPCM 2ch, 48 kHz/16 Bit
HD mode (QuickTime)	
Recording file format	QuickTime File Format
Video	
YUV422 mode, XHQ mode	MPEG-4 AVC/H.264 50 Mbps (Max) 1920x1080/59.94p, 59.94i, 29.97p, 23.98p, 50p, 50i, 25p
UHQ Mode	MPEG-4 AVC/H.264 35 Mbps (Max) 1920x1080/59.94i, 30p, 23.98p, 50i, 25p 1280x720/60p, 50p
Audio	LPCM 2ch, 48 kHz/16 Bit
HD mode (AVCHD)	
Recording file format	AVCHD File Format
Video	
HQ mode	MPEG-4 AVC/H.264 28 Mbps (Max) 1920x1080/60p, 50p MPEG-4 AVC/H.264 24 Mbps (Max) 1920x1080/59.94i, 50i
SP mode	MPEG-4 AVC/H.264, 17 Mbps 1920x1080/59.94i, 50i
Audio	Dolby Digital 2ch, 48 kHz/16 Bit, 256 kbps
SD mode (QuickTime)	
Recording file format	QuickTime File Format
Video	MPEG-4 AVC/H.264, 8 Mbps 720x480/59.94i (U model only), 720x576/50i (E model only)
Audio	LPCM 2ch, 48 kHz/16 Bit
SD mode (AVCHD)	
Recording file format	AVCHD File Format
Video	MPEG-4 AVC/H.264, 8 Mbps 720x480/59.94i (U model only), 720x576/50i (E model only)
Audio	Dolby Digital 2ch, 48 kHz/16 Bit, 256 kbps

Item	Description
Web mode (QuickTime)	
Recording file format	QuickTime File Format
Video	
Mode other than HQ, LP	MPEG-4 AVC/H.264, 8 Mbps 720x480/59.94i, 720x576/50i
HQ mode	MPEG-4 AVC/H.264, 3 Mbps 960x540/29.97p, 23.98p, 25p
LP mode	MPEG-4 AVC/H.264, 1.2 Mbps 480x270/29.97p, 23.98p, 25p
Audio	
Mode other than HQ, LP	LPCM 2ch, 48 kHz/16 Bit
HQ mode, LP mode	μ-law 2ch 16 kHz
Web mode (AVCHD)	
Recording file format	AVCHD File Format
Video	
Mode other than LP, EP	MPEG-4 AVC/H.264, 8 Mbps 720x480/59.94i, 720x576/50i
LP mode	MPEG-4 AVC/H.264, 9 Mbps 1440x1080/59.94i, 50i
EP mode	MPEG-4 AVC/H.264, 5 Mbps 1440x1080/59.94i, 50i
Audio	Dolby Digital 2ch, 48 kHz/16 Bit, 256 kbps
Streaming Mode 200	1920x1080 (60i/50i) Audio AAC 128 k 12/8/5/3 Mbps 1280x720 (30p/25p) Audio AAC 128 k 8/5/3/1.5 Mbps 720x480 (60i) 720x576 (50i) Audio AAC 128 k/64 k/32 k 8/5/3/1.5/0.8/0.3/0.2 Mbps 480x270 (30p/25p) Audio AAC 32 k 0.2 Mbps

Accessories

Accessories	
Warranty Card (U model only)	1
INSTRUCTIONS (BASIC)	1
Document Disc	1
AC Adapter	1
Power Cord (U model: 1, E model: 2)	
Battery	1
Handle Unit 200	1
Hood	1

* Eyepiece and lens cap are attached to the camera recorder.

Dimensional Outline Drawing (Unit: mm)

GY-HM200U/GY-HM200E

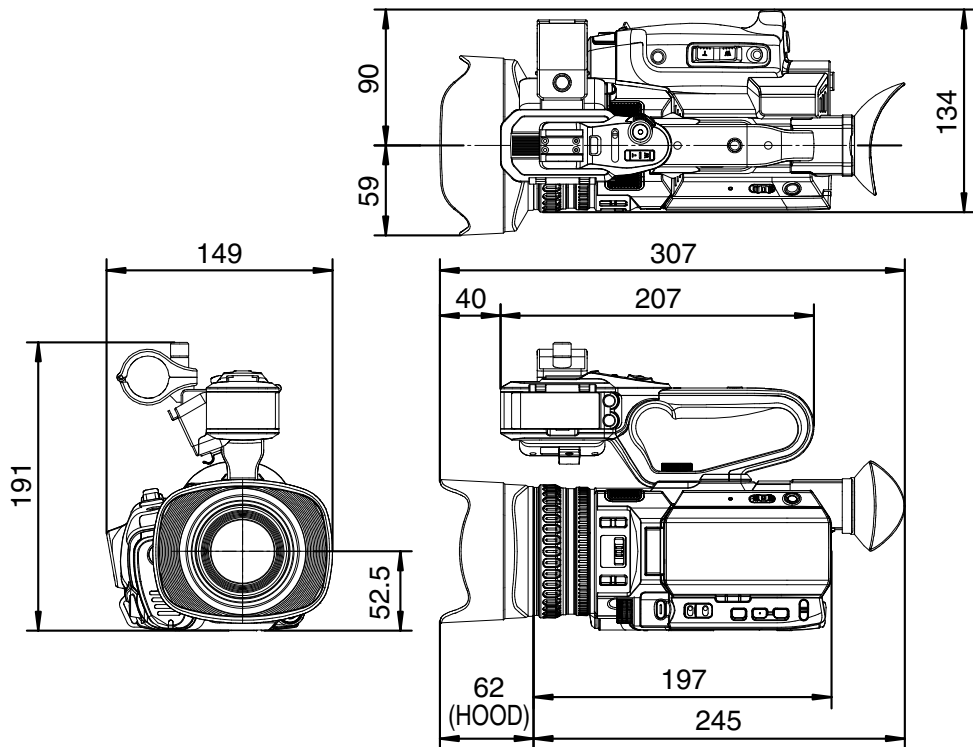

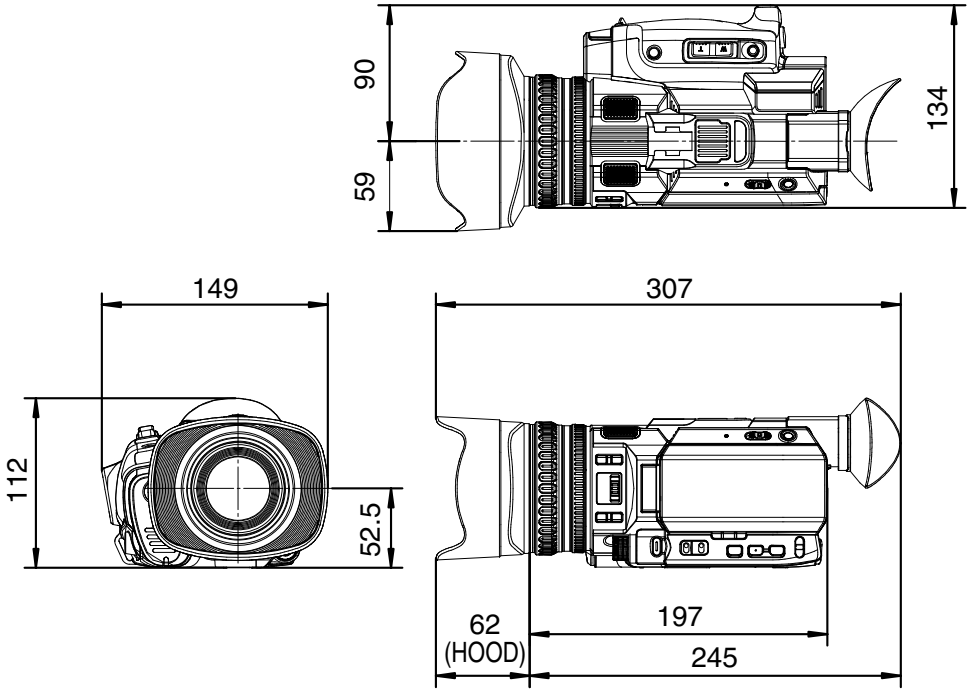

* The specifications and appearance of this product are subject to changes for further improvement without prior notice.

Index

- A** AC adapter 29, 31
 - Access point 143
 - Action 85
 - AF assist 51, 97
 - Aspect ratio 49
- B** Backup rec 76
 - Battery 14, 29
 - Brightness adjustment 54
- C** Camera control function 161
 - Camera mode 19, 35, 127
 - Cellular adapter 145
 - Charging time 30
 - Clip continuous rec 79
 - Clip cutter trig (splitting clips) 82
 - Clip name 44, 84
 - Clip review 73
 - Color bar 135
 - Computer 140
 - Connection settings file 165
 - Continuous operating time 30
- D** Deleting clips 87
 - Display screen 35, 127, 132
 - Dual rec 74
 - Dynamic zoom 49, 97
- E** Electronic shutter 58
 - Error message 63, 170
 - Expanded focus 52
 - External monitor 138
- F** Face detection 53
 - Favorites menu 123
 - FAW (Full Auto White Balance) 60, 97, 99
 - File format 47
 - Focus 50
 - Focus assist 52
 - Formatting (initializing) SD cards 42
 - Frame rec 80
 - FTP server 86, 146, 148
- G** Gain adjustment 57
- H** Headphone 67, 139
- I** Image stabilizer 64
 - Initial settings 33
 - Interval rec 81
 - Iris adjustment 55
- L** LCD monitor 16, 31, 35, 37
 - Lens cover 28
 - Live streaming 167
- M** Marker display 135
 - Media mode 19, 35, 132
 - Menu 92, 93, 95
 - Metadata 146, 151
- N** ND filter 59
 - Network 130, 142
 - Network operating environment 142
- O** OK mark 88
 - One push auto focus 50
 - Operation lock 45
- P** P2P 144
 - Picture quality setting 64
 - Power 31, 32
 - Pre rec 78
 - Preset zoom (browser) 159
 - Preset zoom (camera) 50
 - Push auto focus 51
- R** Recordable time 40
 - Recording simultaneously at two different definitions 74
 - Remote edit mode 19, 36
 - Resolution 47
 - Restoring SD card 43
- S** Safety zone display 135
 - SD/SDHC/SDXC card 15, 40
 - SDI 109, 138
 - Selecting multiple clips 89
 - Series rec 74
 - Setting the date/time 34
 - Setup file 136
 - Shooting 46
 - Software keyboard 94
 - Status screen 36, 134
 - Switching shutter speed 58
- T** Tally lamp 39, 174
 - Thumbnail (detailed screen) 85
 - Thumbnail (standard screen) 83
 - Thumbnail screen 83
 - Time code 68, 69
 - Time code generator 69
 - Time code playback 87

	Trimming	91
U	USB mode	19, 36, 140
	User button	39
	User's bit	68
V	Video format	47
	View remote	158
	Viewfinder	16, 31, 35, 38
W	Warning	36, 174
	Web browser	150, 155, 162
	White balance adjustment	60
	White paint	63
	Wired LAN	145
	Wired remote control	140
	Wireless LAN	143
Z	Zebra pattern	72
	Zoom	49
Symbol		
	4K	47, 115

Software License Agreement

The software embedded in the Product (hereinafter the “Licensed Software”) provided by JVC KENWOOD Corporation (hereinafter the “Licensor”) is copyrighted to or sublicenseable by the Licensor, and this Agreement provides for the terms and conditions which Users shall follow in order to use the Licensed Software. The User shall use the Licensed Software by agreeing with the terms of this Software License Agreement. This Agreement shall be deemed completed at the time the User (hereinafter the “User”) initially used the Product in which the “Licensed Software” is embedded. The Licensed Software may include the software which has been licensed to the Licensor directly or indirectly from any third party. In such case, some third parties require the Users to follow their conditions for use separately from this Software License Agreement. Such software shall not be subject to this Agreement, and the Users are urged to read the “[Important Notice concerning the Software] (P 183)” to be provided separately.

Article 1 General Provision

The Licensor shall grant to the User a non-exclusive and non-transferable (other than the exceptional case referred to in Article 3, Paragraph 1) licensed to use the Licensed Software within the country of the User (the country where the User bought the Product (hereinafter the “Country”).

Article 2 License

1. The license granted under this Agreement shall be the right to use the Licensed Software in the Product.
2. The User shall not duplicate, copy, modify, add, translate or otherwise alter, or lease the Licensed Software and any related documents, whether in whole or in part.
3. The use of the Licensed Software shall be limited to personal purpose, and the Licensed Software shall not be distributed, licensed or sub-licensed whether it is for commercial purpose or not.
4. The User shall use the Licensed Software according to the directions described in the operation manual or help file, and is prohibited to use or duplicate any data in a manner violating the Copyright Law or any other laws and regulations by applying whole or a part of the Licensed Software.

Article 3 Conditions for Grant of License

1. When the User transfers the Product, it may also transfer the license to use the Licensed Software embedded in the Product (including any related materials, updates and upgrades) on condition that no original, copies or related materials continue in the possession of the User, and that the User shall cause the transferee to comply with this Software License Agreement.
2. The User shall not carry out reverse engineering, disassembling, decompiling or any other code analysis works in connection with the Licensed Software.

Article 4 Right pertaining to the Licensed Software

1. Any and all copyrights and other rights pertaining to the Licensed Software and related documents shall belong to the Licensor or the original holder of the right who granted to the Licensor the license or sublicense for the Licensed Software (hereinafter the “Original Rightholder”), and the User shall not be entitled to any right other than the license granted hereunder, in respect of the Licensed Software and any related documents.
2. The User shall, whenever the User uses the Licensed Software, comply with any laws relating to the copyright and other intellectual property rights.

Article 5 Indemnification of Licensor

1. Neither the Licensor nor the Original Rightholder shall be liable for any damage incurred by the User or any third party due to the exercise of the license granted to the User under this Agreement, unless otherwise restricted by law.
2. The Licensor will offer no guarantee for the merchantability, convertibility and consistency with certain objective of the Licensed Software.

Article 6 Liability to Third Party

If any dispute has arisen with any third party due to an infringement upon a copyright, patent or any other intellectual property right that was caused by the User’s use of the Licensed Software, the User shall settle such dispute at the User’s own cost and hold the Licensor and the Original Rightholder harmless from any inconvenience it may cause.

Article 7 Confidentiality

The User shall keep the confidentiality of such portion of the Licensed Software, related documents thereof or any other information to be granted under this Agreement, as well as the conditions of this Agreement as has not yet entered the public domain, and shall not disclose or divulge the same to any third party without approval of the Licensor.

Article 8 Termination

In case the User falls under any of the events described in the following items, the Licensor may immediately terminate this Agreement or claim that the User compensates for the damage incurred by the Licensor due to such event:

- (1) when the User violated any provision of this Agreement; or
- (2) when a petition has been filed against the User for an attachment, provisional attachment, provisional disposition or any other compulsory execution.

Article 9 Destruction of the Licensed Software

If this Agreement is terminated pursuant to the provision of Article 8, the User shall destroy the Licensed Software, any related documents and copies thereof within two (2) weeks from such date of termination.

Article 10 Export Restriction

1. The User shall understand that the Licensed Software shall be subject to the export restrictions adopted by the country of User and any other countries.
2. The User shall agree that the software will be subject to any and all applicable international and domestic laws including the export control regulation of the country of User and any other countries, and any restrictions concerning the end-users, the use by end-users and importing countries to be provided by the country of User and any other countries, and any other governmental authorities.
3. If the User is an agency of the United States of America (the "Government"), the User acknowledge Licensor's representation that the Licensed Software is a "Commercial Item" as defined in Federal Acquisition Regulation (FAR) part 2.101(g) consisting unpublished "Commercial Computer Software" as those items are used at FAR part 12.212 and is only license the User with the same use right Licensor grants all commercial end users pursuant to the terms of this Agreement.

Article 11 Miscellaneous

1. In the event any part of this Agreement is invalidated by operation of law, the residual provisions shall continue in force.
2. Matters not stipulated in this Agreement or any ambiguity or question raised in the construction of this Agreement shall be provided or settled upon good-faith consultation between the Licensor and the User.
3. The Licensor and the User hereby agree that this Agreement is governed by the laws of Japan, and any dispute arising from, and relating to the rights and obligations under, this Agreement shall be submitted to the exclusive jurisdiction of the Tokyo District Court for its first instance.

Important Notice concerning the Software

Software License Attached to the Product :

The Software embedded in the Product is composed of several independent software components, and in each of such individual components (hereinafter the "Licensed Software"), a copyright of either JVC KENWOOD Corporation (hereinafter "JKC") or a third party subsists.

The Product uses the software component designated in the End-User License Agreement that was executed between JKJ and a third party (hereinafter "EULA").

The Licensed Software covers those corresponding to free software, and, as a condition of distribution of the software component in executable format which is based on the license granted under the GNU General Public License or Lesser General Public License (hereinafter "GPL/LGPL"), it requires an availability of the source code for the relevant component. Please refer to the following URL concerning the distribution of the source code;

<http://www3.jvckenwood.com/english/download/gpl/index.html>

Please note that we are unable to answer any inquiry relating to the contents, etc. of the source code. In addition, the Licensed Software includes the software developed or created independently by JKJ and there exists an ownership of JKJ in such software and any accompanying documents, which is protected by the Copyright Law, any international treaties and other applicable laws. As to matters concerning the handling by JKJ of the software components, please refer to the "Software License Agreement" attached hereto. Please note that any software component licensed under "EULA" which is not subject to "GPL/LGPL", and those developed or created independently by JKJ shall not be subject to the requirement for provision of the source code. The software component distributed under "GPL/LGPL" shall be licensed to users without charge, and, therefore, no warranty is given for such software component, either express or implied, within the scope of the applicable laws and regulations. Unless otherwise permitted by applicable laws and regulations or agreed in written form, none of the owners of the copyright or persons entitled to alter or redistribute the software component under the said license shall have any liability for any type of damage or loss resulting from the use of or inability to use such software component. For further details of the conditions of use of such software component or matters required to be complied with, please refer to the relevant "GPL/LGPL".

Users are urged to read the details for the relevant license carefully before using the software component covered by "GPL/LGPL" and embedded in the Product. Since the terms and conditions of individual licenses are provided by parties other than JKJ, the original English version will be displayed by the Product.

- ① Turn on the power.
- ② Press the [MENU/THUMB] button.
- ③ Select [Main Menu] → [System] → [System Information] → [Open Source License].

GY-HM200U/GY-HM200E/
GY-HM170U/GY-HM170E
4K MEMORY CARD CAMERA RECORDER

JVC